

FPI Mag 5000 Electromagnetic Flow Meter

Installation, Operation and Maintenance Manual



Standard Model

For use in non-hazardous locations

HL Model

For use in hazardous locations:

- Class I, Division 2, Groups A B C D, T4
- Class I, Zone 2 IIC T4



30127-06 Rev. 1.0
26AUG2024



Contents

- SAFETY1**
 - Safety Symbols1**
 - Safety Warnings1**

- 1.0 DESCRIPTION OF FLOW METER2**

- 2.0 UNPACKING AND VERIFYING COMPONENTS2**
 - 2.1 Verify Serial Numbers3**
 - 2.2 Verify Information On Cable Tags.....3**
 - 2.3 Tools Required for Installation4**

- 3.0 SENSOR PROBE INSTALLATION4**
 - STEP 1: Names of sensor components5**
 - STEP 2: Detach the cable quick connects6**
 - STEP 3: Verify sensor installation location - upstream and downstream straight-pipe run recommendations.....6**
 - STEP 4: Verify sufficient installation clearance from obstructions8**
 - STEP 5: Installing the pipe valve.....9**
 - STEP 6: Ensure sensor will be installed perpendicular to the pipe10**
 - STEP 7: OPTIONAL STEP: Disassemble the compression seal - For installation of large sensors10**
 - STEP 8: Connecting the sensor onto pipe valve11**
 - STEP 9: OPTIONAL STEP: Reassemble the sensor compression seal11**
 - STEP 10: Insert the sensor probe into the pipe12**
 - STEP 11: Apply a compression load to the sensor14**
 - STEP 12: Install the retaining rods15**
 - STEP 13: Attaching the ground wire16**

- 4.0 SENSOR REMOVAL16**

- 5.0 ELECTRONICS INSTALLATION17**

- 6.0 MAINTENANCE17**

- 7.0 SPECIFICATIONS.....18**

- 8.0 REPLACEMENT PARTS.....23**

- 9.0 RETURNING A UNIT FOR REPAIR24**

- WARRANTY25**



SAFETY

Safety Symbols

Throughout this manual are safety warning and caution information boxes. Each warning and caution box will be identified by a large symbol indicating the type of information contained in the box. The symbols are explained below:



This symbol indicates important safety information. Failure to follow the instructions can result in serious injury or death.



This symbol indicates important information. Failure to follow the instructions can result in permanent damage to the meter or installation site.

Safety Warnings

When installing, operating, and maintaining McCrometer equipment where hazards may be present, you must protect yourself by wearing Personal Protective Equipment (PPE) and be trained to enter confined spaces. Examples of confined spaces are manholes, pumping stations, pipelines, pits, septic tanks, sewage digesters, vaults, degreasers, storage tanks, boilers, and furnaces.

You must follow all state and local laws, as well as Occupational Safety and Health Administration (OSHA) regulations concerning Personal Protective Equipment, confined-space entry, and exposure to bloodborne pathogens. Specific requirements can be found in the OSHA section of the Code of Federal Regulations: *29 CFR, 1910.132 - 1910.140, Personal Protective Equipment; CFR Title 29, Part 1910.146, Permit-Required Confined-Spaces; and 29 CFR, 1910.1030, Bloodborne Pathogens.*



WARNING!

Incorrect installation or removal of FPI Mag meters can result in serious injury or death. Read the instructions in this manual on the proper procedures carefully.



WARNING!

Never enter a confined space without testing the air at the top, middle, and bottom of the space. The air may be toxic, oxygen deficient, or explosive. Do not trust your senses to determine if the air is safe. You cannot see or smell many toxic gases.



WARNING!

Never enter a confined space without the proper safety equipment. You may need a respirator, gas detector, tripod, lifeline, and other safety equipment.



WARNING!

Never enter a confined space without standby/rescue personnel within earshot. Standby/rescue personnel must know what action to take in case of an emergency.



WARNING!

Pressurized pipes should only be hot tapped, cut, or drilled by qualified personnel. If possible, depressurize and drain the pipe before attempting any installation.



WARNING!

Carefully read all safety warning tags attached to the meter.

1.0 DESCRIPTION OF FLOW METER

Hach’s FPI Mag® (Full Profile Insertion) flow meter provides accurate flow measurement for full-pipe clean water applications. The electromagnetic sensor automatically senses and corrects for shifting velocity in the pipe by constantly obtaining an area weighted mean velocity. Model 394 is a forward and reverse flow measurement sensor, and the 395 is a forward only flow measurement sensor. The instrument has all of the features needed to suit a wide variety of applications.

The flow meter is comprised of the innovative FPI Mag sensor (item #1 below) and a transmitter (item #4 below). For transmitter installation instructions, see the manual provided for the transmitter purchased with your system.

The sensor is easily installed without service interruption, and requires no site calibration. Installation without service interruption can be done only when adhering to safe hot-tapping procedures, or in locations already fitted with an appropriate full port ball valve, corporation stop or gate valve.

2.0 UNPACKING AND VERIFYING COMPONENTS

Upon receiving the meter, unpack the contents of the shipping box and verify that the items in Figure 1 are included.

NOTE: If any of the above-listed items are not present, contact the factory before continuing with installation.

Item #	Qty.	Description
1	2	Protective end cap for retaining rods
2	2	Long threaded insertion rods
3	1	FPI Mag Sensor
4	2	Cables with Quick-Connects (Compression cable glands are available as an option)
5	1	FPI Mag Installation Operation and Maintenance Manual
6	1	Transmitter Installation Operation and maintenance Manual
7	2	9/16" or 3/4" reversible ratchet wrench
8	8	Hex nut (3/8" or 1/2")
9	4	Locking cotter pin
10	1	Power cord (8'; 115 VAC)
11	2	Short threaded retaining rods
12	1	Transmitter
13	1	Stainless Steel ball valve & SS nipple
14	1	Calibration Certificate

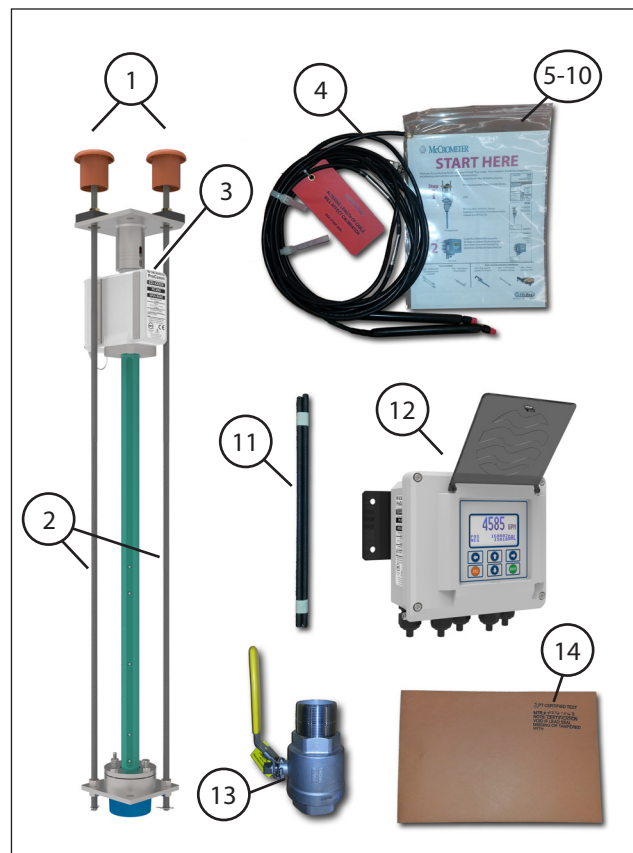
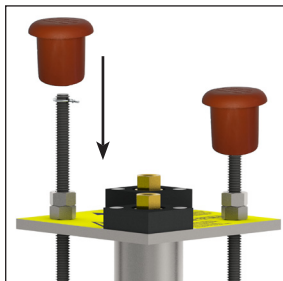

Figure 1. Shipping Box Contents



Note: Do not discard the protective end caps (item 10). They will be needed when the sensor is fully installed. See STEP 12.

2.1 Verify Serial Numbers

The FPI Mag flow meter is comprised of two primary components: the sensor and the transmitter. The transmitter and sensor are supplied as a custom calibrated matched system. Verify the system serial numbers on both the transmitter and sensor match. This will ensure a properly calibrated system.

The Meter Serial Number is located on the side of the sensor body on a silver label. An example is shown below as Figure 2.



Figure 2. Meter Serial Number Tag

The tag on the side of the transmitter has the Transmitter Model Number, the Transmitter Serial Number and the Meter Serial Number. An example is shown below as Figure 3.



Figure 3. Transmitter Serial Number Tag

I **IMPORTANT:** Verify the meter serial numbers on both the transmitter and sensor match. If the Meter Serial Numbers do not match, contact the factory before continuing with the installation.

2.2 Verify Information On Cable Tags

The transmitter cable has two tags located near where the cable enters the transmitter as shown in Figure 4. Verify the following information is consistent with the specifications provided at the time of order:

Tag 1

- Meter Serial Number
- Pipe I.D. (millimeters)
- KA Factor





Tag 2

- Pipe I.D. (inches)
- Total Sensor Length
- Total Cable Length



Figure 4. Cables with Cable Tags

2.3 Tools Required for Installation

<p>Tools provided:</p> <p>2 - 9/16" or 3/4" reversible ratchet wrenches. (Size is dependent on the size of the retaining rods supplied with the sensor and determined at the time of order.)</p> 	<p>Tools recommended for installation:</p> <p>1 - pipe wrench capable of a 4" span</p>  <p>1 - Sensor insertion tool</p> 	<p>1 - 7/16" wrench or crescent wrench</p>  <p>3/8" Part Number 75031 for TSL < 72" and pressure < 200 psi</p> <p>1/2" Part Number 75032 for TSL > 72" or pressure > 200 psi</p>
---	--	---

I IMPORTANT It is recommended that the sensor insertion tool be used for easier and faster installation. See STEP 10.

3.0 SENSOR PROBE INSTALLATION

I Read the entire manual before installing the FPI Mag sensor.

Due to size and pressure requirements determined at the time of order, certain FPI Mag sensors are equipped with more robust 1/2" threaded rods, a heavy spring, a larger top plate and a compression assembly designed to accept the larger insertion rods. For these installations, replace all references to 3/8" rods and nuts with 1/2". The standard sensor size is 1.25". In some smaller applications the FPI Mag may use the smaller 0.75" sensor.

- | | |
|---|---|
| STEP 1: Review names of sensor components | STEP 8: Connect the sensor onto ball valve |
| STEP 2: Detach the cable quick connects | STEP 9: OPTIONAL STEP: Reassemble the sensor compression seal |
| STEP 3: Verify sensor installation location - upstream and downstream straight-pipe run recommendations | STEP 10: Insert the sensor probe through the ball valve into the pipe |
| STEP 4: Verify sufficient installation clearance from obstructions | STEP 11: Apply appropriate compression load to the sensor |
| STEP 5: Installing the ball valve | STEP 12: Install the retaining rods |
| STEP 6: Ensure sensor will be installed perpendicular to the pipe | STEP 13: Attach the ground wire |
| STEP 7: OPTIONAL STEP: Disassemble the compression seal - For installation of large sensors | |

STEP 1: Review names of sensor components

This manual refers to the part names of the sensor. It is important to be familiar with the parts and their names as shown below in Figure 5 when following the installation instructions. For a full list of replaceable parts with part numbers, see Section 8.0.

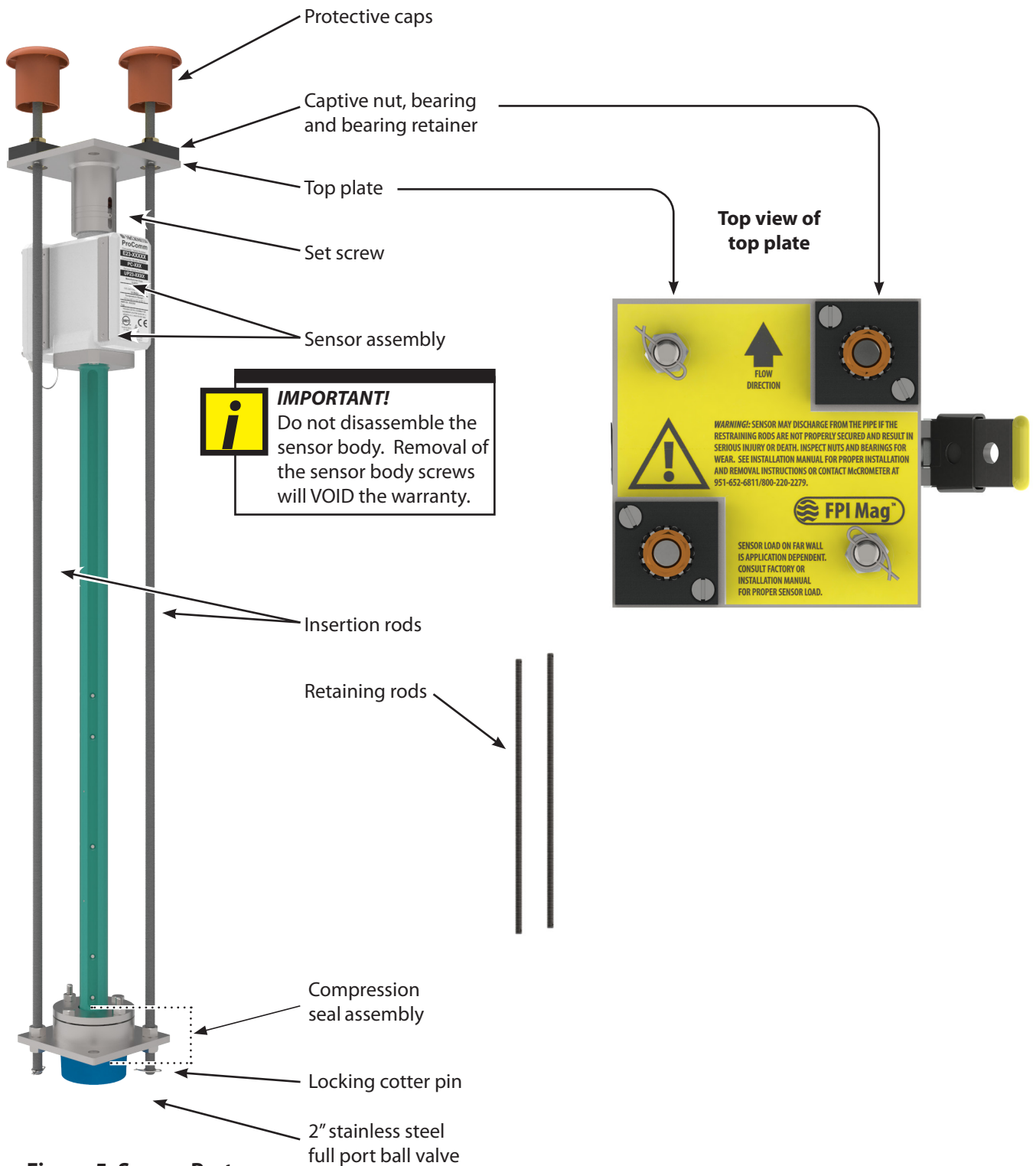

Figure 5. Sensor Parts

STEP 2: Detach the cable quick connects

The sensor cable is fitted with an IP68 rated Quick Connect fitting at the sensor connection. For ease of installation, remove the cable from the sensor and set aside. Compression gland seals are available as an option instead of the Quick Connect cable fittings. (Figure 6)

I IMPORTANT: When the Quick-Connect cable connection is not attached to the sensor, ensure that the threaded caps are attached to the sensor connection and the cable connection to keep the wire connectors free of dirt and corrosion. When the cable is connected to the sensor, connect the end caps together to keep their interior free from dirt and corrosion.

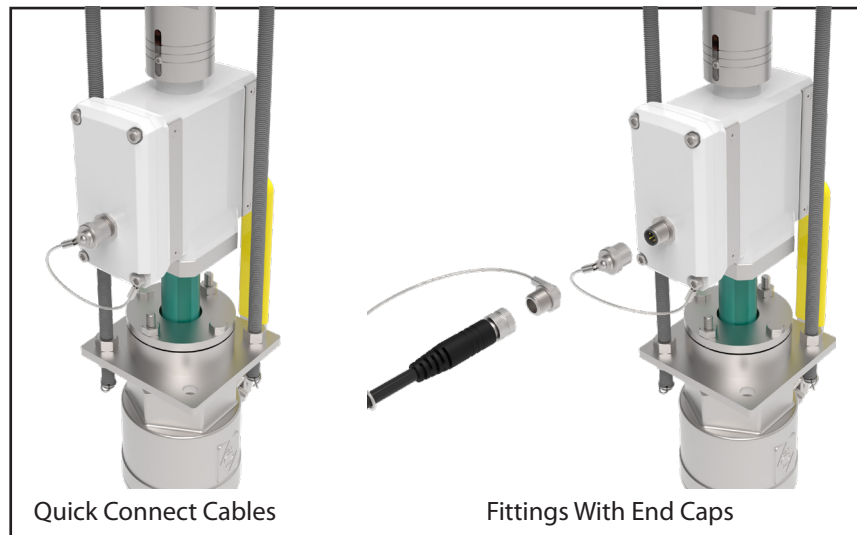

Figure 6. Sensor Cable Fittings

STEP 3: Verify sensor installation location - upstream and downstream straight-pipe run recommendations

Flow disturbers such as partially open valves cause flow disturbances that can adversely affect flow meter accuracy. The table below provides suggestions for the placement of the FPI Mag sensor upstream and downstream of common flow disturbers to meet specification accuracy. The upstream and downstream straight-pipe recommendations are conservative, based on research completed in the McCrometer NIST traceable calibration facility. In many cases, the installation distances suggested below can be shortened depending on flow conditions and piping layout.

Upstream and Downstream Straight Pipe Run Recommendations

Flow Disturbance	Condition	Upstream	Downstream	Notes
Butterfly Valve	100% Open	2D	1D	Meter should be installed perpendicular to the axis of rotation of the valve - See Figure 8
	Non-Actuated Control Valve	5D	1D	For Butterfly Valves that remain in a constant position between 50% to 100% open during operation. Meter should be installed perpendicular to the axis of rotation of the valve - See Figure 8
	Actuating Control Valve	20D; See Note and Figure 7	2D	Recommended to install the sensor 2D upstream of the Automated Control Valves

Flow Disturbance	Condition	Upstream	Downstream	Notes
Gate Valves	100% Open	0D	0D	
	< 100% Open	20D; See Note and Figure 7	2D	Recommended to install the sensor 1D upstream of the Gate Valves
Single 90 Degree Elbows and "T" Fittings	Sensor In Plane with the Elbow - See Figure 9	2D Max; See Note	1D	It is recommended that the sensor be installed as close to the elbow as possible, no further than 2D downstream. Otherwise the recommended upstream piping shall be 7D.
	Sensor Perpendicular to plane of Elbow	7D	2D	None
Single 45 Degree Elbow or pipe bend less than 45 degrees	Sensor In Plane with the Elbow - See Figure 9	1D	1D	None
	Sensor Perpendicular to plane of Elbow	5D	2D	None
Double Elbows In Plane	Sensor In Plane with the Elbows- See Figure 9	2D Max; See Note	1D	It is recommended that the sensor be installed as close to the elbow as possible, no further than 2D downstream. Otherwise the recommended upstream piping shall be 7D.
	Sensor Perpendicular to plane of Elbows	7D	2D	None
Double Elbows Out of Plane	Sensor In plane with last elbow	7D	2D	None
Reduced and Increased Inlets to the Metering Section	ID at Metering Point up to 20% Greater than ID of upstream pipe	5D	1D	Concentric reduction recommended. Example: Meter Section 12" Pipe, upstream section 10" Pipe
	ID at Metering Point up to 50% Less than ID of upstream pipe	0D	0D	Concentric reduction recommended. Example: Meter Section 10" Pipe, upstream section 12" Pipe
Open Discharge	Discharge of pipe is vented to atmosphere	Not Applicable	2D	Full Pipe Required
Pump Discharge	Single Pump	5D	2D	Recommend putting sensor on suction side of pump where possible.
	Multiple Pump on Common Discharge Line	20D; See Note	2D	Recommend putting sensor on suction side of pump where possible.
Filter Discharge	Standard Inline Filter	5D	2D	None

Note: The table above is not inclusive of each possible installation scenario for the Hach's FPI Mag. For installations not included in the table, the McCrometer Applications Team is available to review cases and make a determination as to the viability of the installation. Please feel free to contact us with any questions or concerns.

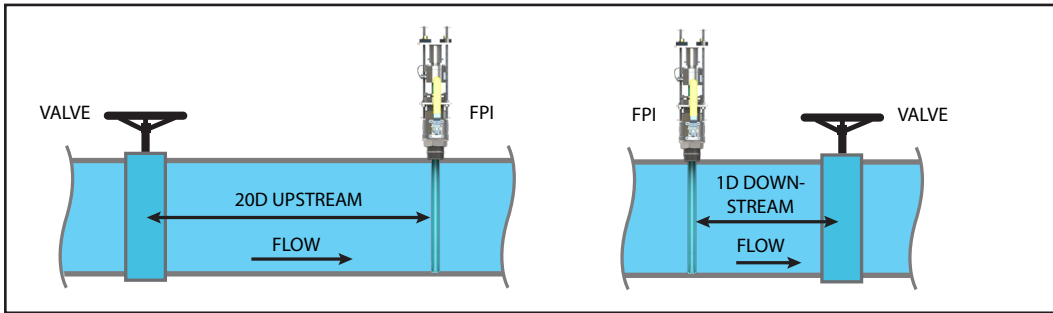

Figure 7. FPI Mag Installation Orientation With A Gate Valve Or Elbow

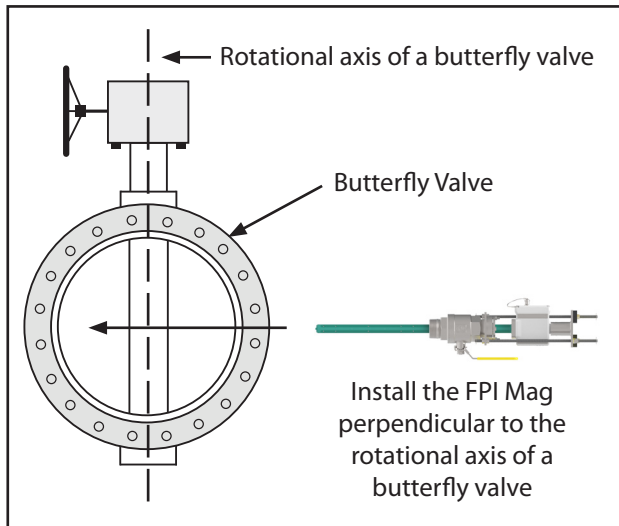

Figure 8. FPI Mag Installation Orientation With A Butterfly Valve

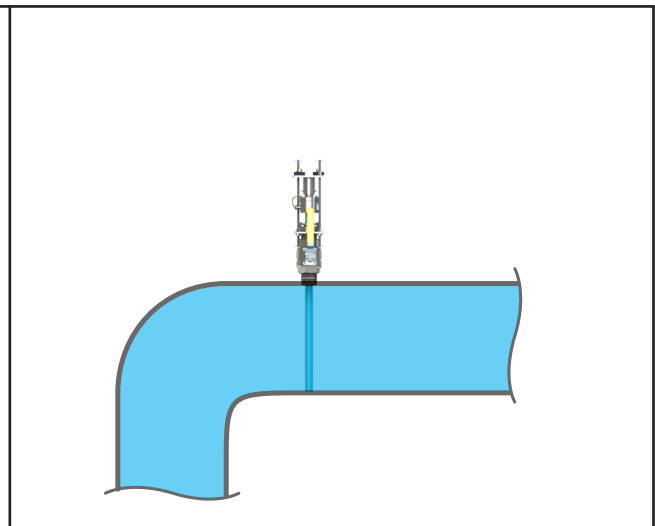
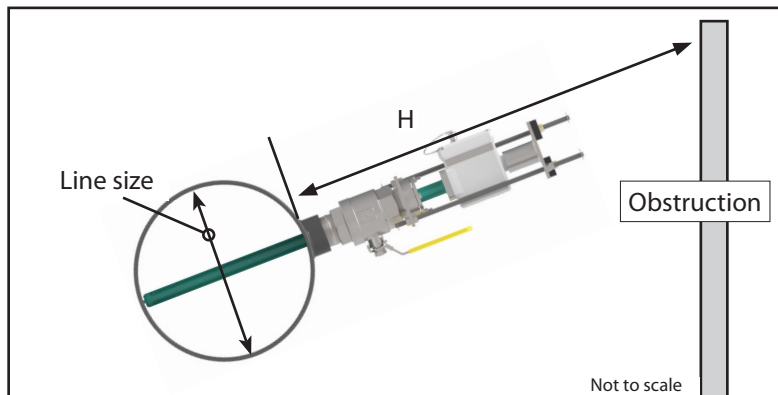

Figure 9. FPI Installed in Place with Elbow

STEP 4: Verify sufficient installation clearance from obstructions

The sensor installation hardware will protrude from the pipe during installation and when installed requiring sufficient clearance (distance H, the required installation clearance, in Figure 10 below) from any obstruction. This distance accounts for the length of the sensor, the distance from the outer pipe wall to the top of the valve plus: 18" is recommended; 12" is the minimum.



Line Size (Inches)	Distance H	Line Size (Inches)	Distance H
4"	51"	24"	67"
6"	51"	30"	71.25"
8"	55"	36"	77.25"
10"	55"	42"	83.25"
12"	59"	48"	89.25"
14"	59"	54"	95.25"
16"	59"	60"	101.25"
18"	63"	66"	107.25"
20"	63"	72"	113.25"
22"	67"	78"-138"	Call Factory

Figure 10. Sensor Clearance Distance

STEP 5: Installing the ball valve



WARNING!

Pressurized pipes should only be hot tapped, cut, or drilled by qualified personnel using high quality saddles, valves and stainless steel nipples. If possible, depressurize the pipe before attempting any installation.

The sensor comes standard with a 2" stainless steel ball valve and a 2" x close stainless steel nipple. The 2" x close stainless steel nipple is to be used if the installation site has a female fitting, i.e., a welded coupling. If the installation site has a male fitting, i.e. a 2" nipple, then the supplied 2" x close stainless steel nipple is not required for the sensor installation.

Use pipe sealant or Teflon thread tape when installing the valve onto the pipe. (Sealant and Teflon tape are not provided.)

NOTE: If using an existing valve or corporation stop insure it has a minimum port inside diameter of 1-7/8" (48mm), and a 2" (50mm) NPT female pipe thread output for the sensor. Ensure that the existing valve and nipple are of high quality.

The valve can be installed onto a welded coupling or pipe saddle. See Figure 11. Alternative ball valve or corporation stop sizes may be used or required. Consult factory for alternative configurations.



IMPORTANT: The MINIMUM port inside diameter for all installation valves is 1-7/8" (48mm).

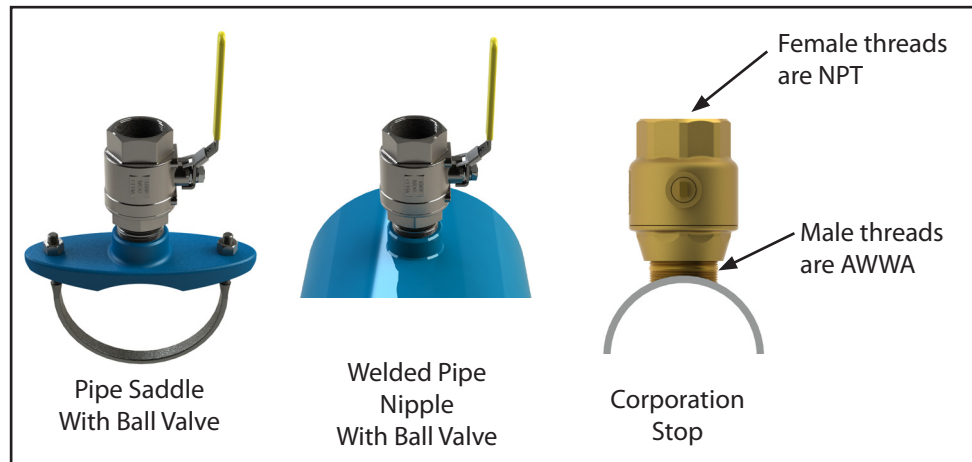

Figure 11. Installation Valve Options

STEP 6: Ensure sensor will be installed perpendicular to the pipe

The FPI should be installed perpendicular to the pipe as shown in Figure 12 for a vertical installation. The allowable tolerance for installation is $\pm 0.5^\circ$. A perpendicular installation is determined by the coupling that is mounted on the pipe. Prior to installing the FPI a level ruler should be used to check the coupling and ensure that it sits level. The FPI will not be perpendicular to the pipe if the coupling does not sit level. Do not install the sensor if the coupling is not mounted perpendicular to the pipe.

The FPI sensor can be installed at any point around the pipe diameter, providing the sensor maintains proper orientation as shown in Figure 13.

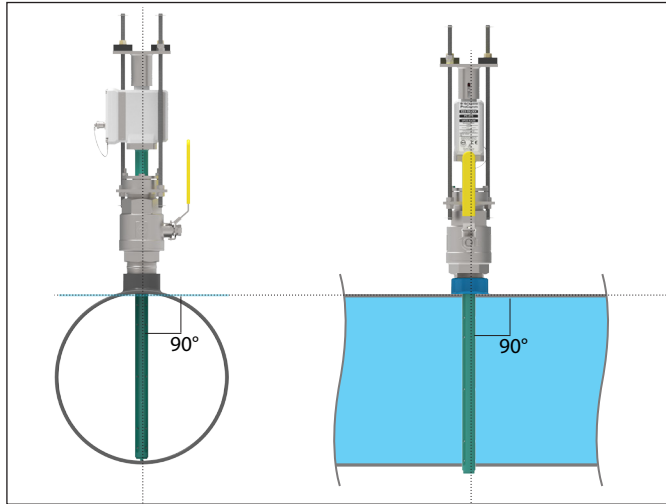

Figure 12. Sensor at 90° relative to pipe

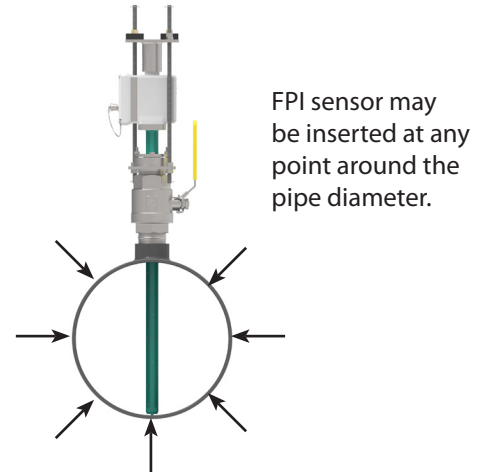

Figure 13. Sensor installation points around pipe diameter

STEP 7: OPTIONAL STEP: Disassemble the compression seal - For installation of large sensors

The sensor assembly can be installed onto the pipe valve as a whole unit. On larger pipe size installations this can be cumbersome or impractical. In such cases the compression seal assembly can be removed from the sensor for easier installation onto the pipe valve. Once the compression seal assembly is installed onto the pipe valve, then the sensor can be re-installed into the compression seal assembly.

NOTE: if this step is skipped, proceed to STEP 8.

The following steps describe the separation of the sensor, top-plate and retaining rods from the compression seal assembly. (See Figure 13)

1. The compression seal has two bolts and two studs with nuts. Loosen the bolts and nuts on the compression seal relieving the pressure on the compression seal. **DO NOT REMOVE THE BOLTS OR NUTS.**
2. On the compression seal assembly, remove the locking cotter pins from the bottom of the two retaining rods under the 3/8" or 1/2" nuts.
3. Remove the lower 3/8" or 1/2" nuts from the retaining rods.
4. Slide the sensor out of the compression seal. The retaining rods will also slide out of the compression seal assembly. Carefully set the sensor and attached hardware to the side.
5. At this point the compression seal assembly can be installed onto the valve.

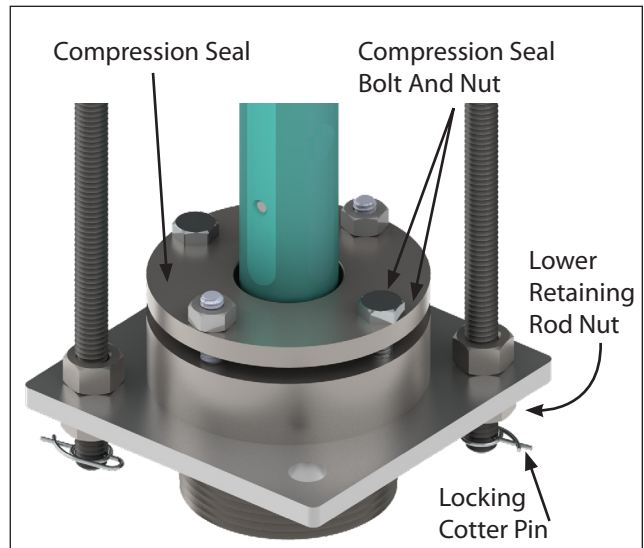

Figure 14. Compression seal removal

STEP 8: Connect the sensor onto ball valve

The sensor assembly uses a compression seal, which keeps the sensor watertight when the pipe is under pressure. Care must be taken when installing the sensor to avoid leaks. Follow the steps below to install the sensor onto the pipe valve:

1. Put a generous amount of the pipe sealant or Teflon tape on the compression seal threads.

I **IMPORTANT**
If pipe sealant gets on the sensor electrodes the velocity signal may be lost. Use care when applying the sealant to the compression seal threads.

2. Place the compression seal threads over the pipe valve. (See Figure 15) Turn the entire sensor assembly clockwise to secure the assembly to the valve. A large pipe wrench can be used to grip the bottom plate of the compression seal to tighten the assembly into the pipe valve.
3. The seal is secure when a large amount of force is required to turn the assembly.
4. The sides of the bottom plate should be parallel with the pipe.
5. Locate the flow direction arrow on the top plate and align it with the direction of the flow in the pipe.

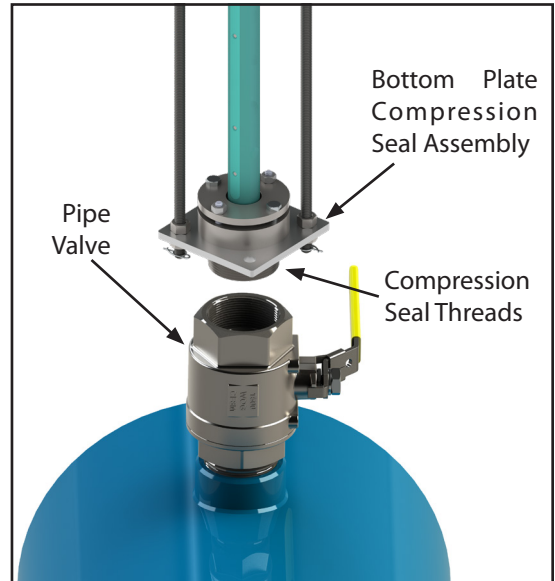

Figure 15. Connecting sensor to the pipe valve

STEP 9: OPTIONAL STEP: Reassemble the sensor compression seal

NOTE: Do this step if you removed the compression seal assembly (STEP 7) and installed it onto the pipe valve separate from the sensor. If you installed the sensor without disassembling it, proceed to the next step.

After the compression seal has been installed onto the pipe valve, follow the steps below to reassemble the sensor into the compression seal assembly. (Figure 16)

1. Apply water or Simple Green to the interior surface of the rubber seal gland. This will act as a lubricant to facilitate the insertion of the sensor and ensure its proper axial loading.
2. Insert the sensor into the compression seal in the bottom plate while inserting the two retaining rods into their respective holes in the bottom plate and secure with one 3/8" or 1/2" nut above and one below the bottom plate.
3. Ensure the two nuts above and below the compression seal assembly are sufficiently tightened to prevent the threaded rod from rotating.
4. Insert the locking cotter pins through the small holes in the bottom of the retaining rods, just below the bottom 3/8" or 1/2" nuts.

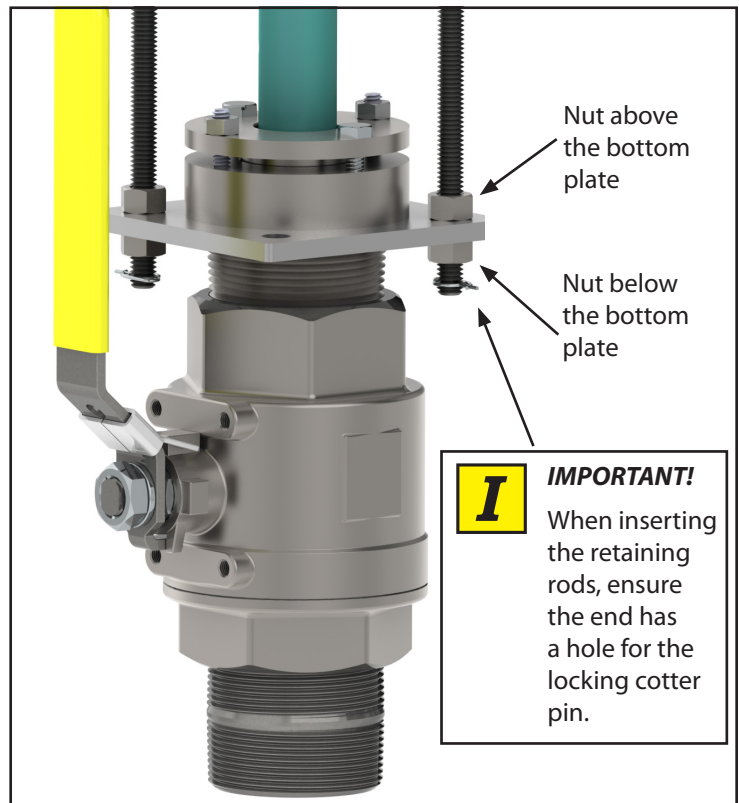

Figure 16. Compression seal reassembly

STEP 10: Insert the sensor probe through the ball valve into the pipe

The sensor can be installed while the line is under flowing conditions. The line water velocity should be as low as possible to prevent sensor vibration during the insertion process. (See Figure 17.) The velocity must be under 5 ft/s.

IMPORTANT! READ THIS BEFORE YOU INSERT THE PROBE!

NOTE 1: Take precautions if the pipe is under pressure



WARNING!

The compression seal/sensor assembly may be under pressure. Serious injury may result if proper procedures are not followed. Do not attempt to install the sensor without the retaining rods fully assembled.



WARNING!

If the meter was disassembled to assist in the installation of the compression seal assembly onto the valve (STEP 7 and STEP 9) it is important to ensure that the meter is properly reassembled with both retaining rods completely installed with the 3/8" or 1/2" nuts properly tightened.

NOTE 2: Ensure the sensor probe tip is seated in the pipe

The sensor probe must be completely inserted in the pipe so that the tip of the probe is seated flush against the opposite side of the pipe. The probe tip is designed with a small flat projection that will minimize contact with the pipe while ensuring the sensor probe remains in place as securely as possible. (Figure 18)

NOTE 3: Using the sensor insertion tool



McCrometer recommends using a sensor insertion tool (see Figure 19) to rotate the captive nuts. This will ensure the top plate compresses evenly and will help avoid any damage to the sensor.

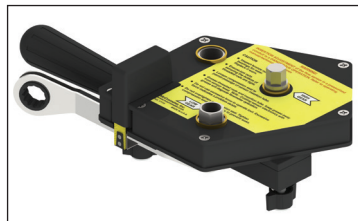

Figure 19. Insertion Tool

NOTE 4: Orient the sensor with the flow direction

Before inserting the sensor probe, ensure the sensor is oriented with the flow direction (Figure 20). The label on the top plate shows the orientation of the meter when it is properly inserted.

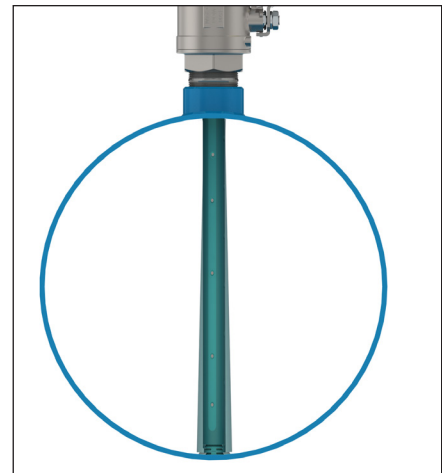

Figure 17. Sensor Vibration

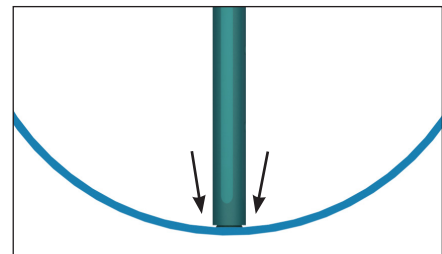

Figure 18. Sensor probe tip seated in pipe



Figure 20. Meter oriented with flow direction

Follow the steps below to insert the sensor probe into the pipe.

1. If you disassembled and reassembled the compression seal, hand tighten the compression seal bolts and nuts. **DO NOT FULLY TIGHTEN THE COMPRESSION SEAL BOLTS AND NUTS.** If you did not disassemble the compression seal, proceed to step 2.
2. If the sensor is being installed under flowing conditions follow this step. If it is not, proceed to step 3.
Slightly open the valve to allow a little water into the compression seal assembly. Some water will leak from the compression seal. Lightly tighten the compression seal bolts and nuts as required to minimize the amount of water exiting the compression seal. A towel draped around the compression seal can reduce spray if necessary.
3. **Open the valve completely.** Failure to open the valve completely will cause the valve to scrape the sensor during insertions and may result in permanent damage to the sensor.

If you are using the sensor insertion tool:

4. Place the sensor insertion tool over the retaining rods and slide the retaining rods through the holes in the tool until it sits over the captive nuts.
5. Lock it into place with spring locks located on the bottom of the tool.
6. Using the provided wrench rotate the high gear shaft clockwise. (Figure 21)
7. Continue to insert the sensor until the sensor probe tip reaches the far wall of the pipe and the load spring starts to compress.
8. Use the low gear shaft to apply pressure to the sensor when the sensor touches the other side of the pipe. Compression of the load spring is indicated by the movement of the set screw on the top plate (see STEP 11).



Figure 21. Inserting the sensor with the insertion tool

If you are NOT using the sensor insertion tool:



IMPORTANT

If the captive nuts are not tightened simultaneously, the top plate will become crooked and cause the sensor to be inserted at an angle and may cause permanent damage to the sensor.

4. Rotate the two captive nuts (Figure 22) on the top plate clockwise simultaneously with the provided 9/16" ratchet wrenches. This will insert the sensor probe into the pipe.
5. Continue inserting the sensor until the sensor probe tip reaches the far wall of the pipe and the load spring starts to compress. Compression of the load spring is indicated by the movement of the set screw on the top plate (see STEP 11).

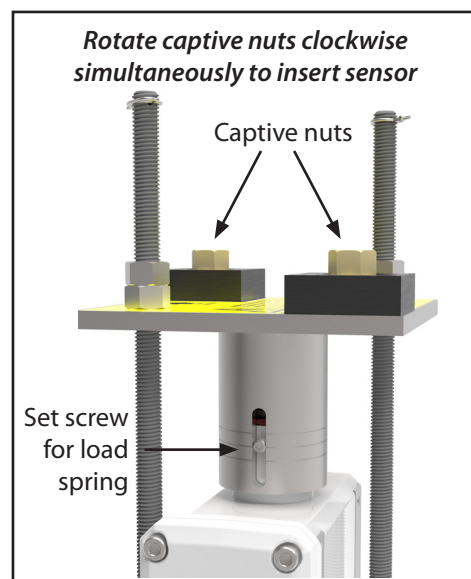

Figure 22. Captive Nuts

STEP 11: Apply appropriate compression load to the sensor

A compression load is required to be applied at the top of the sensor forcing the bottom of the sensor to seat firmly against the far wall of the pipe. The amount of load is indicated by the three lines etched into the top plate and the location of the set screw relative to the lines. See Figure 23 and the table below.

Set Screw Location	Compression Load	Recommended Use
At the lowest line	300 lbs.	Low pressure plastic pipes
Between the lowest line and the middle line	450 lbs.	Low pressure metal pipes
Between the top line and the middle line	Consult Factory	Applications other than low pressure. Consult factory before applying a compression load greater than 450 lbs.

For applications other than low pressure the sensor load should be increased. Consult factory for the appropriate loading for your application before applying a compression load greater than 450 lbs. Follow the steps below to apply a compression load to the sensor:

1. Rotate the two captive nuts on the top plate simultaneously and evenly until the proper load is indicated by the set screw's relationship to the lines etched on the top plate. See Figure 23.

I IMPORTANT
 If using the insertion tool, rotate the two captive nuts using only the low gear shaft until the proper load is indicated. **DO NOT** use the high gears on the insertion tool as this may create too much load too fast and damage the sensor or the pipe.

2. Tighten the compression seal bolts and nuts just enough to stop any leaking from the seal. See Figure 24.

I IMPORTANT
 Do not overtighten the compression seal as it may cause damage to the seal itself.

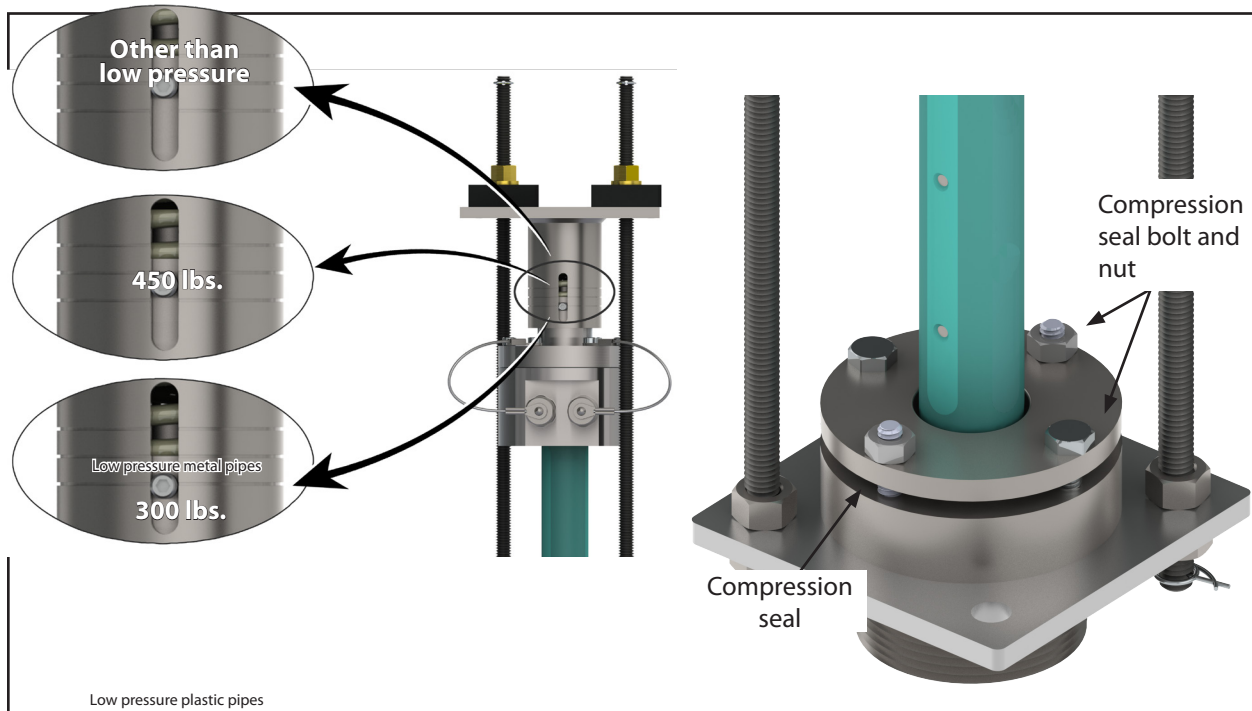

Figure 23. Sensor Load Indicators

Figure 24. Compression Seal Bolts

STEP 12: Install the retaining rods

After the sensor has been inserted and the load adjusted, remove the insertion rods and install the shorter retaining rods. This will make the sensor assembly more compact. (Figure 25)



If the short retaining rods are not used, run a 3/8" or 1/2" nut down against each captive nut to prevent the captive nut from rotating.



IMPORTANT

The insertion rods are matched to each sensor and are required to remove the sensor. It is important to safely store the insertion rods and label them with the meter serial number.



WARNING!

Do not remove the installation rods until the short retaining rods are secured with cotter pins.

Follow the steps below to install the short retaining rods:

1. Insert the two short retaining rods through the two holes in the top plate opposite the two captive nuts with the long retaining rods. Once the short retaining rods are passed through the top plate, thread one nut per rod onto the bottom of the rod about one inch from the bottom.
2. Insert the two short rods end through the corresponding holes on the compression seal bottom plate. Thread a nut onto the bottom of each short retaining rod.
3. Tighten the nuts above and below the compression seal bottom plate to secure the short retaining rods to the bottom plate and to prevent the short retaining rods from spinning.
4. Attach a locking cotter pins to bottom ends of the short retaining rods.
5. Secure the short retaining rods to the top plate with one 3/8" or 1/2" nuts per rod.
6. Remove the long retaining rods and store in a safe, dry location tagged with the meter serial number.
7. Check and adjust the "Sensor Load" as necessary. See STEP 11.
8. Secure the 3/8" or 1/2" nuts on the top plate by running a second jam nut down and tightening it against the first nut.
9. Attach a locking cotter pin to the top ends of the short retaining rods.
10. Place the protective caps on the ends of the two retaining rods over the cotter pins.

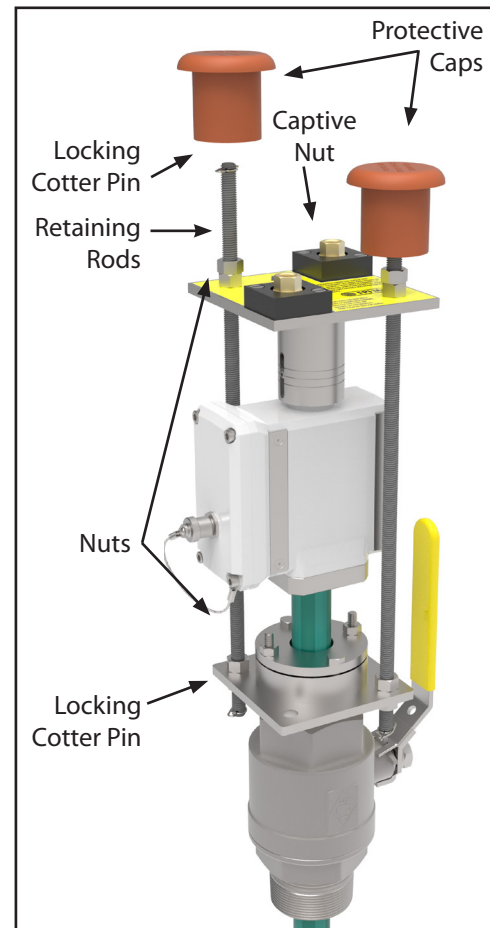

Figure 25. Installed Short Retaining Rods

STEP 13: Attach the ground wire

The FPI meter is electrically continuous to a conductive (non PVC) pipe through the retaining rods. Additional grounding may be required to a dedicated earth ground via ring terminal and 10 AWG wire (not provided). (Figure 26)

VFD's and chemical injection mechanisms may have adverse effects on the electromagnetic signal. Contact the factory for further information on grounding effects.

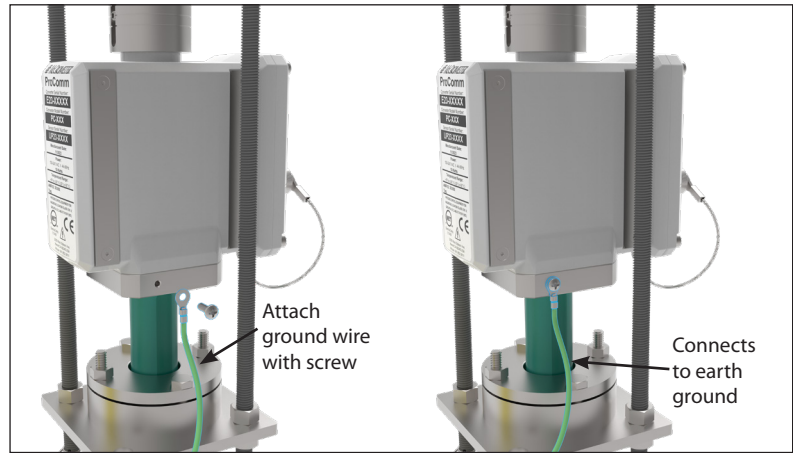

Figure 26. Attaching the Ground Wire

4.0 SENSOR REMOVAL

WARNING! The pipe may be under pressure. Serious injury or death may result if proper procedures are not followed. Do not attempt to remove the short retaining rods without the long retaining rods properly installed. Do not attempt to remove the sensor with only the short retaining rods.

I IMPORTANT Use the long retaining rods provided with the meter for removal. If the rods used for removal are shorter than those provided by the factory, the sensor cannot be removed without depressurizing the line.

Follow the steps below to safely remove the sensor:

1. Visually inspect the pipe and entire assembly for damage or corrosion paying close attention to any nipples and welded couplings. If there is any doubt as to the condition of any element of the pipe or meter, depressurize the line before attempting to remove the meter.
2. Reduce line velocity to 5 ft/s or less to prevent sensor vibration, or depressurize the line.
3. Thread a long retaining rod through the captive nut until the rod nears the compression assembly. Ensure that the bottom of the rod has the hole for the locking cotter pin.
4. Thread a 3/8" nut onto the bottom of the long retaining rod about an inch up from the bottom of the rod.
5. Continue rotating the long retaining rod until the bottom of the rod passes through the holes on the bottom plate.
6. Thread another 3/8" or 1/2" nut onto the bottom of the long retaining rod until it is flush with the bottom plate. Tighten the nuts above and below the bottom plate securely locking the long retaining rod in place. Attach the locking cotter pin into the hole through the bottom of the long retaining rod.

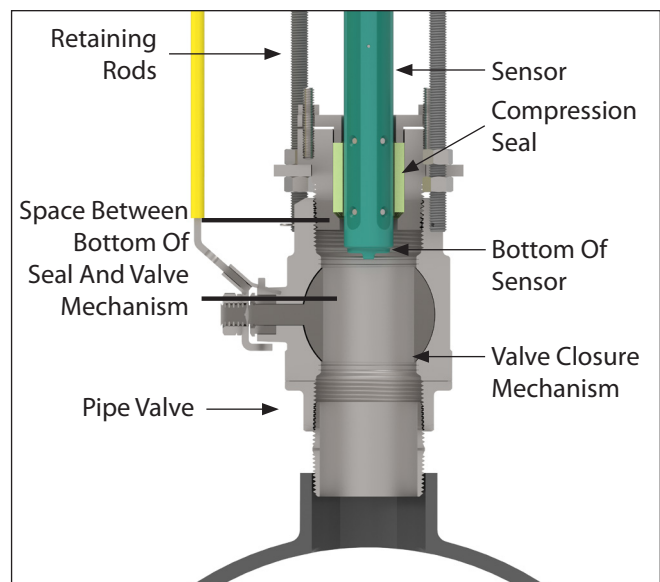

Figure 27. Cross-Section Of Meter Showing Sensor Removal

7. Repeat the process for the second long retaining rod.
8. Once both of the long retaining rods are securely in place, completely remove the short retaining rods.
9. Loosen the compression seal bolts until the seal just begins to leak. This will relieve the pressure on the compression seal allowing the sensor to be removed. Draping a towel around the compression seal can reduce any spraying water. NOTE: The compression seal may prevent immediate leakage on sensors installed for a long period of time until the sensor begins to rise.
10. Rotate the captive nuts on the top plate simultaneously. The sensor insertion tool is recommended. See Installation, STEP 10. This will cause the sensor to rise out of the pipe. If the line is under pressure do not remove the sensor from the compression seal completely. Only raise the sensor until it is clear of the valve, but still below the compression seal. See Figure 27. Once the sensor has cleared the valve mechanism, the valve can then be closed. Do not attempt to force the valve closed while the sensor is still passing through the valve as permanent damage to the sensor can occur.
11. Once the valve is closed, the entire sensor can be removed from the valve.

5.0 ELECTRONICS INSTALLATION

See the Installation, Operation and Maintenance Manual for the transmitter supplied with your system.

6.0 MAINTENANCE

Hach's FPI Mag is essentially a maintenance free meter with no user serviceable parts. However, the metered fluid may contain solids or other contaminants which may coat the sensor electrodes. A periodic inspection may be recommended to ensure the sensor electrodes are clean. To clean the unit, remove the sensor following all of the instructions and safety warnings contained in Section 4.0. When the sensor is removed from the pipe, carefully wipe down the sensor with a soft cloth and rubbing alcohol.

7.0 SPECIFICATIONS

FPI Mag 5000 Flow Meter Specifications

The full pipe averaging flow meter comes complete with Mounting Hardware, AC Converter with Dual 4-20mA output, 25 Feet of Dual Submersible Cables with quick connects at sensor, Stainless Steel Body, 316 Stainless Steel Electrodes, NSF Approved Fusion Bonded Epoxy Coating, 2" Stainless Steel Ball Valve (minimum of 1-7/8" port I.D.), 2" x Close Stainless Steel Nipple, 2-Year Warranty.

Physical Specifications

Measurement	Electromagnetic
Directionality	Forward and reverse
Pipe Sizes	Up to 138"
Body Style	Full profile insertion
Materials	<ul style="list-style-type: none"> Stainless steel body 316 stainless steel electrodes NSF approved fusion bonded epoxy coating 2" stainless steel ball valve (minimum of 1-7/8" port I.D.) 2" x close stainless steel nipple
Coating	Fusion bonded epoxy (NSF 61 approved) coated 316 stainless steel
Electrodes	316 Stainless Steel, Hastelloy optional
Electrical Connections	Quick Connect
Electronics	<ul style="list-style-type: none"> FPI Mag 3000: ProComm GO electronics FPI Mag 5000: ProComm Max transmitter
Electronics Mount	Remote mount only
Sensor Cable Lengths	<ul style="list-style-type: none"> Standard: 25'/7.6 m McCrometer supplied submersible cable with each remote mount unit. Optional: Up to 500'/152.4 m, or 25'/7.6 m max for battery powered. Quick connect: Available in standard cable lengths: Feet: 25, 50, 75, 100, 125, 150, 175, 200, 500 Meters: 7.6, 15.25, 22.5, 30.5, 38.1, 45.75, 53.3, 61, 152.4 Custom quick connect cable lengths at additional cost.
Insertion Hardware	316 Stainless Steel
Compression Seal	Silicone Rubber

Performance and Operational Specifications

Measurement Method	Volumetric flow in filled flow conduits 4" (100 mm) to 138" (3,500 mm) utilizing insertable electromagnetic averaging sensor. Flow indication in English Standard or Metric units.
Direction Measurement	<ul style="list-style-type: none"> 395 sensor: Forward flow measurement and reverse flow indication 394 sensor: Bidirectional flow measurement
Operating Temperature	-10 to 60°C (14 to 140°F) up to 250 PSI
Storage Temperature	<p>-15 to 60°C (5 to 140° F)</p> <p>Note regarding storage: During freezing conditions and when meter is not in use, sensor must be removed from pipe and stored in dry conditions.</p> <p>Note: Damage to the sensor caused by allowing the sensor freeze in the pipe is not covered by the warranty.</p>
IP Rating	<ul style="list-style-type: none"> Standard model: Quick Connect (IP68) HL model: Quick Connect (IP67)

FPI Mag 5000 Flow Meter Specifications (cont.)

Sensor Submersibility Depth	With standard quick connect: 9 m (30 ft.)
Velocity Range	See following pages flow velocity ranges by line size for each type of electronics.
Calibrated accuracy for forward and bidirectional sensors	<ul style="list-style-type: none"> • ProComm Max Electronics: $\pm 0.5\%$ of measured value ± 0.006 ft/s (± 0.0018 m/s) • ProComm Go Electronics : $\pm 1\%$ of measured value ± 0.006 ft/s (± 0.0018 m/s) • Reverse Flow: $\pm 1\%$ of measured value ± 0.006 ft/s (± 0.0018 m/s)
Linearity	0.3% of Range
Repeatability	0.2% of Reading
Pipe Run Requirements	Pipe run requirements for the FPI Mag sensor can vary, depending on the disturbances in the pipe run. See FPI Mag flow meter manual 30127-05 or 30127-06, step 3 of the installation procedure for a table of upstream and downstream straight-pipe run recommendations.

9.1 Other Specifications

Certifications and Approvals	<p>Standard model:</p> <ul style="list-style-type: none"> • ISO 9001:2015 certified quality management system • NSF/ANSI/CAN 61 & NSF/ANSI 372 • Certified by MET to UL 61010-1 <p>HL Model:</p> <ul style="list-style-type: none"> • ISO 9001:2015 certified quality management system • NSF/ANSI/CAN 61 & NSF/ANSI 372 • Certified by MET to UL 61010-1 and MET C22.2 No. 61010-1-04 <ul style="list-style-type: none"> • Class I, Division 2, Groups A-D, T4 • Class I, Zone 2, IIC T4
System Options	<ul style="list-style-type: none"> • Hastelloy electrodes • Annual verification / calibration • Stainless steel ID tag
Meter Options and Accessories	<ul style="list-style-type: none"> • Sensor insertion tool • Extension to hardware clearance • Additional sensor cable up to 475' (500' max for model 395 and 200' max for model 394)
Warranty	2 years

* Certified by IAPMO R&T to NSF/ANSI 61 for material safety and NSF/ANSI 372 for low lead content.

Note regarding cable length: McCrometer recommends minimizing cable length. Electromagnetic flow meters may have unfavorable signal strength to noise ratio in electrically noisy environments. Longer lengths of cable increase the likelihood of interference. In those cases where the meter’s signal must be transmitted a long distance, or where the environment may be particularly noisy, we suggest using the converter’s analog output(s) that allows locating the transmitter as close as possible to the metering location.

Flow Meter Pipe Sizes and Flow Ranges with ProComm Max Transmitter

Imperial Units

Pipe Size (Nominal)	Pipe ID Range		Flow Ranges (GPM Standard)		Standard Program Defaults ¹	Minimum Clearance Required During Installation ²	Velocity Range ³ (f/s)	
	Min Pipe ID	Max Pipe ID	Min (GPM) ¹	Max (GPM) ¹	20mA (GPM)			
S = Standard (Available in 395 models Pipe Sizes 4" - 24" as shown in table below) C = Custom (Available in all 394 and 395 models Pipe Sizes 4" - 138") Standard Length Hardware and Installation Clearance Dimensions are based on a 4" Maximum Height Coupling and Pipe Schedule Standard								
4"	3.74	4.99	12	1280	1280	51"	0.3 - 32	
6"	5.00	7.24	26	2800	2800	51"	0.3 - 32	
8"	7.25	9.24	47	5000	5000	55"	0.3 - 32	
10"	9.25	11.24	80	8000	8000	55"	0.3 - 32	
12"	11.25	12.99	110	11000	11000	59"	0.3 - 32	
14"	13.00	14.99	150	15000	15000	59"	0.3 - 32	
16"	15.00	16.75	190	20000	20000	59"	0.3 - 32	
18"	16.76	18.80	240	26000	26000	63"	0.3 - 32	
20"	18.81	22.74	300	28000	28000	63"	0.3 - 28	
24"	22.75	24.99	410	33000	33000	67"	0.3 - 23	
30"	25.00	33.99	600	44000	44000	71.25"	0.3 - 20	
36"	34.00	39.99	1000	48000	48000	77.25"	0.3 - 15	
42"	40.00	45.99	1300	56000	56000	83.25"	0.3 - 13	
48"	46.00	51.99	1700	62000	62000	89.25"	0.3 - 11	
54"	52.00	57.99	2200	79000	79000	95.25"	0.3 - 11	
60"	58.00	63.99	2600	97000	97000	101.25"	0.3 - 11	
66"	64.00	69.99	3200	106000	106000	107.25"	0.3 - 10	
72"	70.00	75.99	3800	127000	127000	113.25"	0.3 - 10	
78"-128"	76.00	138.00	Available - Call Factory at 1-800-220-2279					

¹ Default totalizer units measured as KGAL.

² Hardware clearance after installation for all sizes is 28".

³ Flow temperature range -10° to 60° C (14° to 140° F) up to 250 PSI, max pressure is 250 psi.

Required Information

At the time of ordering, please be prepared to provide the following information:

1. Pipe ID and Pipe OD
2. Unit of Measure (US Gallons is Default)
3. Maximum pressure
4. FPI Specification Data Sheet for custom length sensors

Consult factory if any chemicals are in use.

PROCOMM MAX TRANSMITTER SPECIFICATIONS
Physical Specifications

Electronic Housing	Diecast aluminum, powder coated enclosure w/ tamper resistant seal
Transmitter Dimensions	Remote Mount: Height: 7.3" (18.5 cm) Width: 8.5" (21.6 cm) Depth: 4.3" (10.9 cm) Meter Mount: Height: 6.9" (17.5 cm) Width: 7.2" (18.25 cm) Depth: 6.2" (15.7 cm)
Power	AC Power: 100-240 VAC / 47-66 Hz (10 W) DC Power: 10-35 VDC (10 W) Note: AC or DC must be specified at time of ordering.
Connection Options	Conduit option: 1/2" NPT threaded connections
Galvanic Isolation	All outputs are galvanically isolated from power supply up to 500 V
Conductivity	Minimum conductivity of 5µS/cm

Performance and Operational Specifications

Location	Indoor or outdoor use
Operating and Storage Temperature	-4° to 140° F (-20° to 60° C)
IP Rating	IP67 Die cast aluminum transmitter
Standard Outputs	Single 4-20mA (standard). Galvanically isolated and fully programmable for zero and full scale. A second 4-20mA is available. Two separate digital programmable outputs: open collector transistor usable for pulse, frequency, or alarm settings. <ul style="list-style-type: none"> • Volumetric Pulse • Range Indication • Maximum switching voltage: 35 VDC • Maximum switching current: 100mA • Insulation from other secondary circuits: 500V • Datalogger (12-hour increments as default)
Optional Outputs	<ul style="list-style-type: none"> • Modbus • HART • Ethernet IP • Smart Output™ (Sensus, Itron 6, Itron 9)

Display and Measurement

Keyboard and Display	Can be used to access and change set-up parameters using six membrane keys and an LCD display					
Units	GAL	Gallons	B42	Barrel (42G)	MH1	Miners Inch Hour (11.22G)
	CUF	Cubic Feet	B46	Barrel (46G)	MD1	Miners Inch Day (11.22G)
	AFT	Acre Feet	B55	Barrel (55G)	MH9	Miners Inch Hour (9G)
	CUM	Cubic Meters	IMG	Imperial Gallon	MD9	Miners Inch Day (9G)
	LIT	Liters	AIN	Acre Inch	KGL	Kilo Gallons
	MML	Megaliter	TON	Ton (Short)	MGL	Mega Gallons
	MTT	Metric Ton (KL)	MM1	Miners Inch Minute (11.22G)	IN3	Cubic Inch
	B31	Barrel (31G)	MM9	Miners Inch Minute (9G)		

Other Specifications

Standard Model

- ISO 9001:2015 certified quality management system
- Certified by MET to UL 61010-1

HL Model

- ISO 9001:2015 certified quality management system
- Certified by MET to UL 61010-1 and MET C22.2 No. 61010-1-04
 - Class I, Division 2, Groups A B C D, T4
 - Class I, Zone 2, IIC T4



IMPORTANT

Refer to certification requirements. Do not substitute components.

8.0 REPLACEMENT PARTS

Diagram Number	Description	Part Number
1	Protective Cap	FPI-002RP
2	Captive Nut	42226
2	Captive Nut Bearing Retainer	42225
2	Captive Nut Bearing	92121
3	Top Plate for use with 3/8" retaining rods	MIM043
3	Top Plate for use with 1/2" retaining rods	MIM053
4	Set screw (2 ea.)	920001001
5	Spring	920000901
5	Heavy Spring	920000903
6	1/2" High Strength SS Short Threaded Rods (2 ea.)	X6743
7	3/8" SS Long Threaded Rods (2 ea.)	64006
8	Compression Seal (3/4" sensor)	MIM017-1
8	Compression Seal (1 -1/4" sensor)	MIM012-1
9	Compression Seal Assembly	Contact Factory
10	3/8" SS Nut (8 ea.)	93007
10	1/2" SS Nut (8 ea.)	10755
11	3/8" Locking Cotter Pin	921000701
11	1/2" Locking Cotter Pin	921000702
12	2" Stainless Steel Full Port Ball Valve with SS Nipple (Min. 1 7/8" dia. port)	43059-1

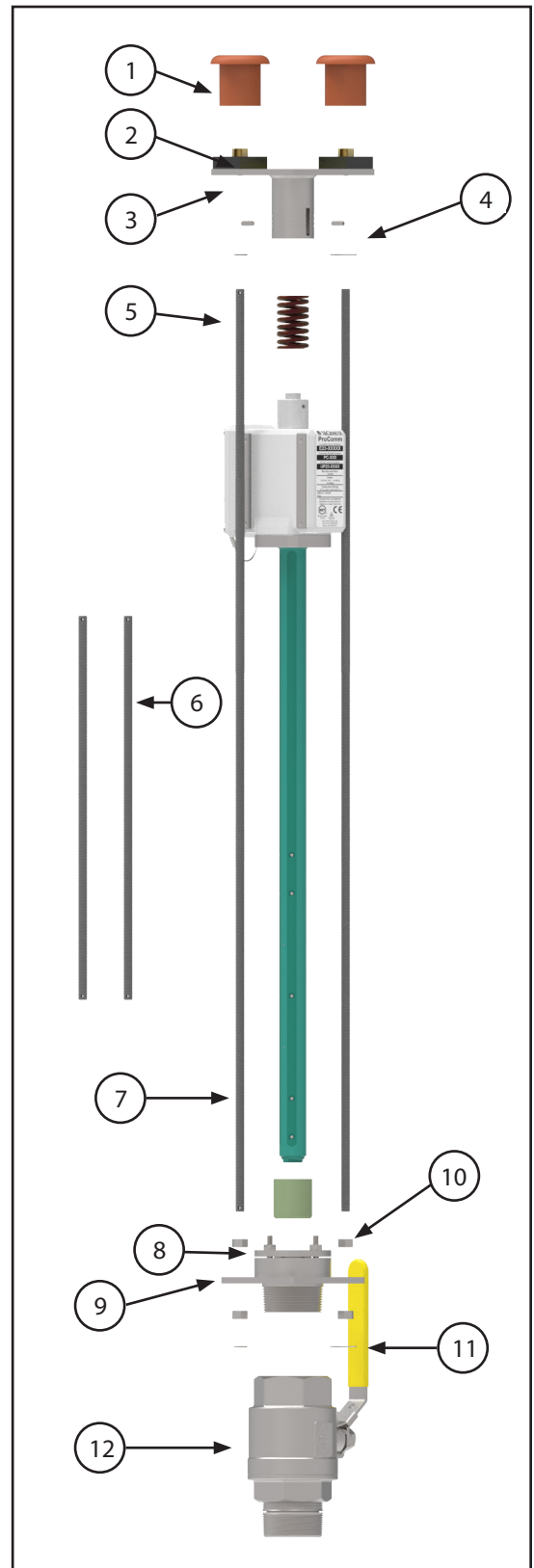

9.0 RETURNING A UNIT FOR REPAIR

If the unit needs to be returned to the factory for repair, please do the following:

Prior to calling for a return authorization number, determine the model number, serial number (located inside the front panel of the transmitter), and reason for return.

- Contact McCrometer Customer Service Department and ask for a Return Authorization (RA) number.
 - Telephone: 1-800-220-2279
 - Email: customerservice@mccrometer.com
- Please make sure the meter is clean and free from foreign debris prior to shipping.
- Ship the meter in the original packaging, if possible. Do not ship manuals, power cords, or other parts with your unit unless required for repair.
- Write the RA number on the outside of the shipping box. All return shipments should be insured.
- Address all shipments to:

McCrometer, Inc.
RA #
3255 W. Stetson Avenue
Hemet, CA 92545

WARRANTY

McCrometer warrants that this product will be free from defects in material and workmanship for a period 24 months from the date the equipment was first installed, but in no event longer than 30 months from the date the equipment was first shipped by McCrometer. Repairs shall be warranted for 12 months or, if the repair is performed under this warranty, for the remainder of the original warranty period, whichever is less.

Buyer shall report any claimed defect in writing to McCrometer immediately upon discovery and in any event, within the warranty period. McCrometer shall, at its sole option, repair the equipment or furnish replacement equipment or parts thereof, at the original delivery point.

McCrometer shall not be liable for costs of removal, reinstallation, or gaining access. If Buyer or others repair, replace, or adjust equipment or parts without McCrometer prior written approval, McCrometer is relieved of any further obligation to Buyer under this Article with respect to such equipment.

No equipment furnished by McCrometer shall be deemed to be defective by reason of normal wear and tear, failure to resist erosive or corrosive action of any fluid or gas (unless otherwise specified in Quotations/ Purchase Order Specifications), Buyer's direct or indirect failure (or the failure of its agents or contractors) to properly store, install, operate, or maintain the equipment in accordance with good industry practices or specific recommendations of McCrometer, or Buyer's failure to provide complete and accurate information to McCrometer concerning the operational application of the equipment.

THE FOREGOING LIMITED WARRANTIES WITH RESPECT TO EQUIPMENT AND PRODUCTS ARE EXCLUSIVE AND IN LIEU OF ANY AND ALL OTHER WARRANTIES OF QUALITY OR PERFORMANCE, EXPRESS, IMPLIED OR STATUTORY, INCLUDING, WITHOUT LIMITATION, ANY AND ALL WARRANTIES OF MERCHANTABILITY OR FITNESS OF SAID EQUIPMENT AND PRODUCTS FOR ANY PARTICULAR PURPOSE.

MCCROMETER DISCLAIMS ANY WARRANTY, WHETHER EXPRESS OR IMPLIED, REGARDING THE SUITABILITY OF PRODUCTS AND EQUIPMENT SUPPLIED PURSUANT TO ANY PURCHASE ORDER FOR INSTALLATION IN ANY PARTICULAR SYSTEM OF SYSTEMS. MCCROMETER MAKES NO WARRANTY OF ANY KIND WITH RESPECT TO ANY SERVICES PERFORMED BY MCCROMETER OR ITS AGENTS PURSUANT TO ANY QUOTATION.

Purchaser's sole remedy and manufacturer's sole obligation for alleged product failure, whether under warranty claim or otherwise, shall be the aforesaid obligation of manufacturer to repair or replace products returned within twenty-four months after date of original shipment. The manufacturer shall not be liable for, and the purchaser assumes and agrees to indemnify and save harmless the manufacturer in respect to, any loss or damage that may arise through the use by the purchaser of any of the manufacturer's products.

McCrometer does not authorize any person or entity (including, without limitation, McCrometer agents and employees) to make any representations (verbal or written) contrary to the terms of this limited warranty or its exclusions. Such terms of this limited warranty and its exclusions can only be effectively modified in writing and only by the President of McCrometer.



McCrometer, Inc.
3255 West Stetson Avenue
Hemet, CA 92545 USA
Tel: 951-652-6811
800-220-2279
Fax: 951-652-3078
customerservice@mccrometer.com
www.mccrometer.com