

**USEPA<sup>1</sup> PhosVer® 3 with Acid Persulfate Digestion Method****Method 8190****0.06 to 3.50 mg/L PO<sub>4</sub><sup>3-</sup> (0.02 to 1.10 mg/L P)****Test 'N Tube™ Vials****Scope and application:** For water, wastewater and seawater.<sup>1</sup> USEPA accepted for reporting wastewater analyses (Standard Methods 4500-P E).

## Test preparation

### Instrument-specific information

Table 1 shows all of the instruments that have the program for this test. The table also shows adapter and light shield requirements for the instruments that use them.

To use the table, select an instrument, then read across to find the applicable information for this test.

**Table 1 Instrument-specific information for test tubes**

Instrument	Adapters	Light shield
DR 6000, DR 5000	—	—
DR 3900	—	LZV849
DR 3800, DR 2800, DR 2700	—	LZV646
DR 1900	9609900 (D <sup>1</sup> )	—
DR 900	4846400	Cover supplied with the instrument

### Before starting

Install the instrument cap on the DR 900 cell holder before ZERO or READ is pushed.

DR 3900, DR 3800, DR 2800 and DR 2700: Install the light shield in Cell Compartment #2 before this test is started.

For the best results, measure the reagent blank value for each new lot of reagent. Replace the sample with deionized water in the test procedure to determine the reagent blank value. Subtract the reagent blank value from the sample results automatically with the reagent blank adjust option.

The test range for total phosphate is limited to 0.06 to 3.5 mg/L PO<sub>4</sub><sup>3-</sup>. Test results that are more than 3.5 mg/L can be used to estimate dilution ratios, but should NOT be used for reporting purposes. If the test result is more than 3.5 mg/L, dilute the sample and repeat the digestion and the colorimetric test.

Clean all glassware with 6.0 N (1:1) hydrochloric acid, then fully rinse with deionized water to remove contaminants.

The reagent that is used in this test is corrosive. Use protection for eyes and skin and be prepared to flush any spills with running water.

Review the Safety Data Sheets (MSDS/SDS) for the chemicals that are used. Use the recommended personal protective equipment.

Dispose of reacted solutions according to local, state and federal regulations. Refer to the Safety Data Sheets for disposal information for unused reagents. Refer to the environmental, health and safety staff for your facility and/or local regulatory agencies for further disposal information.

<sup>1</sup> The D adapter is not available with all instrument versions.

## Items to collect

Description	Quantity
Total Phosphorus Test 'N Tube Reagent Set	1
DRB200 Reactor	1
Funnel, micro	1
Light shield or adapter (For information about sample cells, adapters or light shields, refer to <a href="#">Instrument-specific information</a> on page 1.)	1
Pipet, TenSette <sup>®</sup> , 1.0- to 10.0-mL, with pipet tips	1
Test tube rack	1
Water, deionized	varies

Refer to [Consumables and replacement items](#) on page 5 for order information.

## Sample collection and storage

- Collect samples in clean glass or plastic bottles that have been cleaned with 1:1 hydrochloric acid and rinsed with deionized water.
- Analyze the samples as soon as possible for best results.
- Do not use a detergent that contains phosphate to clean the sample bottles. The phosphate in the detergent will contaminate the sample.
- To preserve samples for later analysis, adjust the sample pH to less than 2 with concentrated sulfuric acid (about 2 mL per liter). No acid addition is necessary if the sample is tested immediately.
- Keep the preserved samples at or below 6 °C (43 °F) for a maximum of 28 days.
- Let the sample temperature increase to room temperature before analysis.
- Before analysis, adjust the pH to 7 with 5.0 N sodium hydroxide standard solution.
- Correct the test result for the dilution caused by the volume additions.

## Acid persulfate digestion for Test 'N Tubes

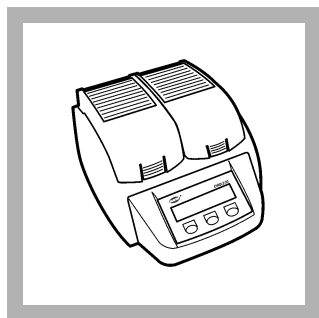

**1.** Start the DRB200 Reactor. Preheat to 150 °C. Refer to the DRB200 manual.

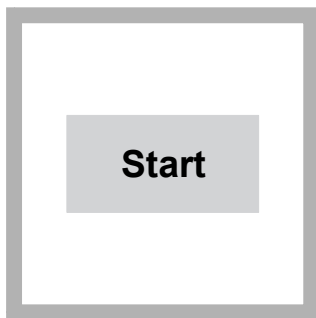

**2.** Start program **536 P Total/AH PV TNT**. For information about sample cells, adapters or light shields, refer to [Instrument-specific information](#) on page 1.



**3.** Add 5.0 mL of sample to the Total Phosphorus Test Vial.

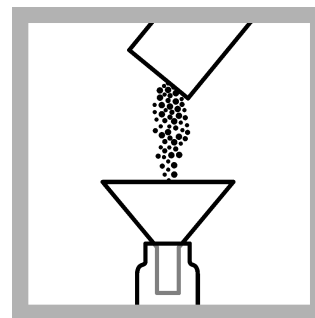

**4.** Add the contents of one Potassium Persulfate Powder Pillow for Phosphonate to the vial.

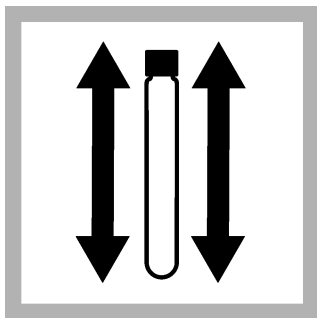

5. Put the cap on the vial. Shake to dissolve the powder.

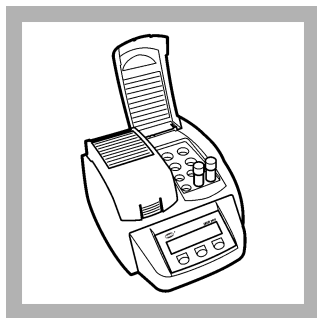

6. Insert the vial into the reactor. Close the reactor.



7. Start the instrument timer. A 30-minute reaction time starts.

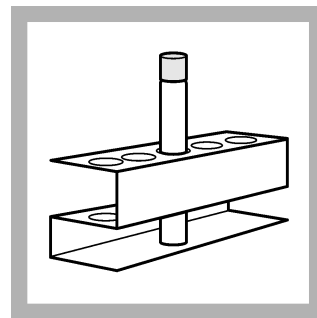

8. When the timer expires, carefully remove the vial from the reactor. Set the vial in a test tube rack. Let the vial cool to room temperature.

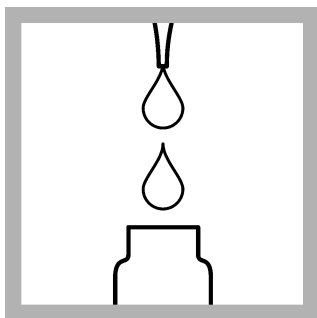

9. Add 2 mL of 1.54 N Sodium Hydroxide Standard Solution to the vial.

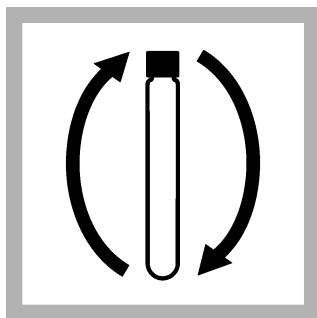

10. Put the cap on the vial. Invert to mix.

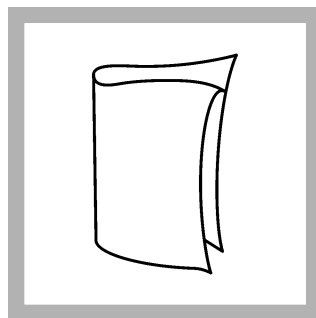

11. Clean the vial.

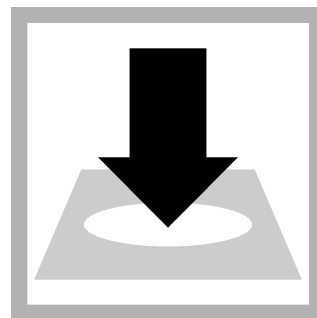

12. Insert the vial into the 16-mm cell holder.

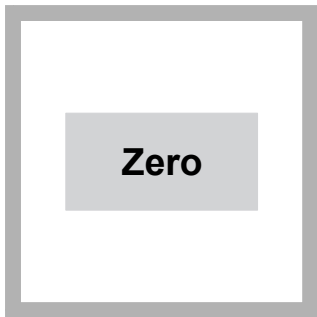

13. Push **ZERO**. The display shows 0.00 mg/L  $\text{PO}_4^{3-}$ .

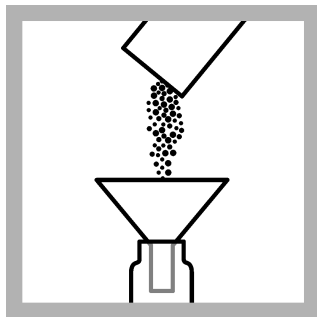

14. Add the contents of one PhosVer 3 Powder Pillow to the vial.

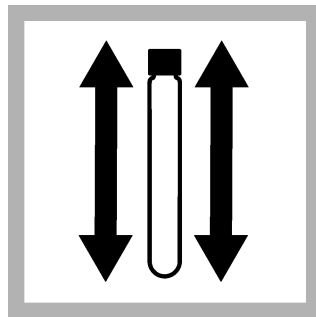

15. Put the cap on the vial. Shake to mix for 20–30 seconds. The powder will not dissolve completely.

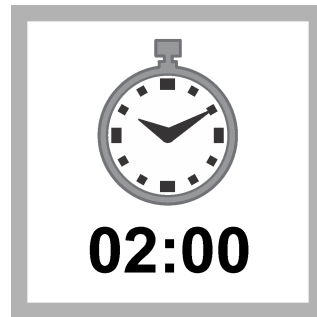

16. Start the instrument timer. A 2-minute reaction time starts. Measure the sample within 8 minutes after the timer expires.

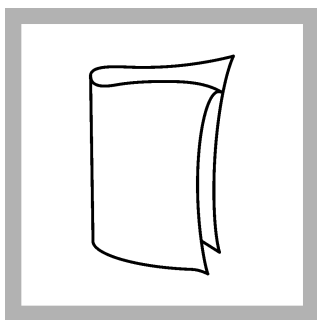

17. Clean the vial.

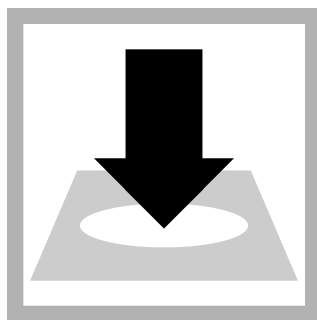

18. Insert the vial into the 16-mm cell holder.



19. Push **READ**. Results show in mg/L  $\text{PO}_4^{3-}$ .

## Interferences

Interfering substance	Interference level
Aluminum	More than 200 mg/L
Arsenate	Interferes at any level
Chromium	More than 100 mg/L
Copper	More than 10 mg/L
Sulfide	More than 90 mg/L
Iron	More than 100 mg/L
Nickel	More than 300 mg/L
Highly buffered samples or extreme sample pH	Can prevent the correct pH adjustment (of the sample) by the reagents. Sample pretreatment may be necessary.
Silica	More than 50 mg/L
Silicate	More than 10 mg/L
Turbidity or color	Samples with a high amount of turbidity can give inconsistent results. The acid in the reagents can dissolve some of the suspended particles and variable desorption of orthophosphate from the particles can occur.
Zinc	More than 80 mg/L

## Accuracy check

### Standard additions method (sample spike)

Use the standard additions method (for applicable instruments) to validate the test procedure, reagents and instrument and to find if there is an interference in the sample.

Items to collect:

- Phosphate 10-mL Ampule Standard, 50-mg/L as  $\text{PO}_4^{3-}$
- Ampule breaker
- Pipet, TenSette®, 0.1–1.0 mL and tips
- Mixing cylinders, 25-mL (3)

1. Use the test procedure to measure the concentration of the sample, then keep the (unspiked) sample in the instrument.
2. Go to the Standard Additions option in the instrument menu.
3. Select the values for standard concentration, sample volume and spike volumes.
4. Open the standard solution.
5. Prepare three spiked samples: use the TenSette pipet to add 0.1 mL, 0.2 mL and 0.3 mL of the standard solution, respectively, to three 25-mL portions of fresh sample. Mix well.

6. Use the test procedure to measure the concentration of each of the spiked samples. Start with the smallest sample spike. Measure each of the spiked samples in the instrument.
7. Select **Graph** to compare the expected results to the actual results.  
*Note: If the actual results are significantly different from the expected results, make sure that the sample volumes and sample spikes are measured accurately. The sample volumes and sample spikes that are used should agree with the selections in the standard additions menu. If the results are not within acceptable limits, the sample may contain an interference.*

### Standard solution method

Use the standard solution method to validate the test procedure, the reagents and the instrument.

Items to collect:

- 3.0-mg/L phosphate standard solution
1. Use the test procedure to measure the concentration of the standard solution.
  2. Compare the expected result to the actual result.

*Note: The factory calibration can be adjusted slightly with the standard adjust option so that the instrument shows the expected value of the standard solution. The adjusted calibration is then used for all test results. This adjustment can increase the test accuracy when there are small variations in the reagents or instruments.*

### Method performance

The method performance data that follows was derived from laboratory tests that were measured on a spectrophotometer during ideal test conditions. Users can get different results under different test conditions.

Program	Standard	Precision (95% confidence interval)	Sensitivity Concentration change per 0.010 Abs change
536	3.00 mg/L PO <sub>4</sub> <sup>3-</sup>	2.93–3.07 mg/L PO <sub>4</sub> <sup>3-</sup>	0.06 mg/L PO <sub>4</sub> <sup>3-</sup>

### Summary of method

Phosphates present in organic and condensed inorganic forms (meta-, pyro- or other polyphosphates) must be converted to reactive orthophosphate before analysis. Pretreatment of the sample with acid and heat provides the conditions for hydrolysis of the condensed inorganic forms. Organic phosphates are converted to orthophosphates by heating with acid and persulfate. Orthophosphate reacts with molybdate in an acid medium to produce a mixed phosphate/molybdate complex. Ascorbic acid then reduces the complex, giving an intense molybdenum blue color. The measurement wavelength is 880 nm (DR 1900: 710 nm) for spectrophotometers or 610 nm for colorimeters.

### Pollution prevention and waste management

Reacted samples contain molybdenum and must be disposed of as a hazardous waste. Dispose of reacted solutions according to local, state and federal regulations.

### Consumables and replacement items

#### Required reagents

Description	Quantity/test	Unit	Item no.
Water, deionized	varies	100 mL	27242
Total Phosphorus Test 'N Tube™ Reagent Set	1	50 tests	2742645
Includes:			
PhosVer® 3 Phosphate Reagent Powder Pillow, 10 mL	1	50/pkg	2106046
Potassium Persulfate Powder Pillow	1 pillow	50/pkg	2084766

## Consumables and replacement items (continued)

Description	Quantity/test	Unit	Item no.
Sodium Hydroxide, 1.54 N	varies	100 mL	2743042
Total and Acid Hydrolyzable Test Vials (not sold separately)	1	50/pkg	—

## Required apparatus

Description	Quantity/test	Unit	Item no.
DRB 200 Reactor, 110 VAC option, 15 x 16-mm wells	1	each	LTV082.53.40001
DRB 200 Reactor, 220 VAC option, 15 x 16-mm wells	1	each	LTV082.52.40001
Funnel, micro, poly	1	each	2584335
Light shield, DR 3900	1	each	LZV849
Light shield, DR 3800, DR 2800, DR 2700	1	each	LZV646
Pipet, TenSette <sup>®</sup> , 1.0–10.0 mL	1	each	1970010
Pipet tips, for TenSette <sup>®</sup> Pipet, 1.0–10.0 mL	2	250/pkg	2199725
Test tube rack	1	each	1864100

## Recommended standards and apparatus

Description	Unit	Item no.
Drinking Water Standard, Mixed Parameter, Inorganic for F <sup>-</sup> , NO <sub>3</sub> -N, PO <sub>4</sub> <sup>3-</sup> , SO <sub>4</sub> <sup>2-</sup>	500 mL	2833049
Phosphate Standard Solution, 50-mg/L, 10-mL Voluette <sup>®</sup> Ampules	16/pkg	17110
Phosphate Standard Solution, 1 mg/L as PO <sub>4</sub> <sup>3-</sup>	500 mL	256949
Phosphate Standard Solution, 3-mg/L as PO <sub>4</sub> <sup>3-</sup>	946 mL	2059716
Wastewater Effluent Standard Solution, Mixed Parameter, for NH <sub>3</sub> -N, NO <sub>3</sub> -N, PO <sub>4</sub> <sup>3-</sup> , COD, SO <sub>4</sub> <sup>2-</sup> , TOC	500 mL	2833249
Ampule Breaker, 10-mL Voluette <sup>®</sup> Ampules	each	2196800

## Optional reagents and apparatus

Description	Unit	Item no.
Mixing cylinder, graduated, 25 mL	each	189640
Pipet, volumetric, Class A, 2 mL	each	1451536
Hydrochloric Acid Solution, 6.0 N (1:1)	500 mL	88449
Sodium Hydroxide Standard Solution, 5.0 N	1 L	245053
Sulfuric Acid, concentrated, ACS	500 mL	97949
Pipet, TenSette <sup>®</sup> , 0.1–1.0 mL	each	1970001
Pipet tips for TenSette <sup>®</sup> Pipet, 0.1–1.0 mL	50/pkg	2185696
Pipet tips for TenSette <sup>®</sup> Pipet, 0.1–1.0 mL	1000/pkg	2185628
Bottle, sampling, with cap, low density polyethylene, 250 mL	12/pkg	2087076
Paper, pH, 0–14 pH range	100/pkg	2601300
Water, deionized	4 L	27256
Thermometer, non-mercury, –10 to +225 °C	each	2635700
Finger cots	2/pkg	1464702

---

**Optional standards**

Description	Unit	Item no.
Phosphate Standard Solution, 10-mg/L as PO <sub>4</sub> <sup>3-</sup>	946 mL	1420416
Phosphate Standard Solution, 15-mg/L as PO <sub>4</sub> <sup>3-</sup>	100 mL	1424342
Phosphate Standard Solution, 100-mg/L as PO <sub>4</sub>	100 mL	1436832
Phosphate Standard Solution, 10-mL ampule, 500 mg/L as PO <sub>4</sub>	16/pkg	1424210
Phosphate Standard Solution, 500-mg/L as PO <sub>4</sub>	100 mL	1424232



**FOR TECHNICAL ASSISTANCE, PRICE INFORMATION AND ORDERING:**

In the U.S.A. – Call toll-free **800-227-4224**

Outside the U.S.A. – Contact the **HACH office or distributor serving you.**

On the Worldwide Web – **[www.hach.com](http://www.hach.com)**; E-mail – **[techhelp@hach.com](mailto:techhelp@hach.com)**

**HACH COMPANY**  
WORLD HEADQUARTERS  
Telephone: (970) 669-3050  
FAX: (970) 669-2932