



DOC023.53.90634

Sample preconditioning panels

User Manual

03/2020, Edition 3

Section 1 Legal information	3
Section 2 Specifications	5
Section 3 General information	7
3.1 Safety information.....	7
3.1.1 Use of hazard information.....	7
3.1.2 Precautionary labels.....	7
3.1.3 Chemical and biological safety.....	8
3.2 Product overview.....	9
3.2.1 Filtration—EZ-size.....	9
3.2.2 Filtration—EZ-size heavy duty (anaerobic digestion).....	10
3.2.3 Filtration—EZ-size heavy duty (wastewater).....	11
3.2.4 Microfiltration.....	12
3.2.5 Moduplex—Multichannel option.....	13
3.3 Product components.....	14
Section 4 Installation	15
4.1 Installation guidelines.....	15
4.2 Attach the instrument to a wall.....	15
4.3 Electrical installation.....	16
4.4 Plumb the panel.....	16
4.4.1 EZ-size connections.....	17
4.4.2 Microsize connections.....	17
Section 5 Startup	19
Section 6 Operation	21
6.1 Set valves and pressures.....	21
6.2 Program the timer.....	22
Section 7 Maintenance	23
7.1 Maintenance schedule.....	23
7.2 Examine for leaks and malfunctions.....	23
7.3 Examine the pressure.....	23
7.4 Rinse the panel with water.....	23
7.5 Clean and replace the filter.....	24
7.6 Replace the sample pump tubing (EZ-size and Microsize only).....	24
7.7 Clean the drain piping.....	24
7.8 Replace the peristaltic pump tubing.....	25
7.9 Shut down the panel.....	26
Section 8 Replacement parts and accessories	27

Section 1 Legal information

Manufacturer: AppliTek NV/SA

Distributor: Hach Lange GmbH

The translation of the manual is approved by the manufacturer.

Section 2 Specifications

Specifications are subject to change without notice.

Table 1 EZ9000 series, EZ-size—Self-cleaning in-line filtration system

Specification	Details
Dimensions (W x H x D)	500 × 1170 × 260 mm (19.68 × 46.06 × 10.2 in.)
Enclosure	IP55 optional (indoor installation)
Weight	13 kg (28.6 lb) approximately
Material of filtration membrane	Stainless steel, SS316
Filtration pore size	50, 100, 200, 1000, 2000 µm
Lifetime of the filter	> 5 years in usual conditions ¹
Power requirements	24 VDC (supplied from analyzer)
Power consumption	8 W
Electrical fuse protection	1 A
Operating temperature	5 to 85 °C (41 to 185 °F); 5 to 95% relative humidity, non-condensing, non-corrosive
Storage temperature	-20 to 60 °C (-4 to 140 °F), ≤ 95% relative humidity, non-condensing
Sample temperature	5 to 85 °C (41 to 185 °F)
Sample pH range	3 to 9 ²
Sample flow	25 to 35 mL/min
Instrument air pressure (cleaning)	3.5 bar (50 psi)
Certifications	—
Warranty	USA: 1 year, EU: 2 years

Table 2 EZ9100 series, EZ-size heavy duty—Self-cleaning in-line filtration for difficult samples

Specification	Details
Dimensions (W x H x D)	750 × 1150 × 200 mm (29.5 × 45.3 × 7.9 in.)
Enclosure	IP55 optional (indoor installation)
Weight	18 kg (39.7 lb)
Materials	Filter: Stainless steel, SS 316L; Piping: PV; Pneumatic ball valves: PVC; Tubing: Norprene, PFA, PE; Panel: weather resistant Trespa
Filtration pore size	Standard: 50, 100, 200, 500 µm Sludge applications: 1000, 2000 µm Anaerobic digestion: 200, 500 µm
Power requirements	24 VDC (supplied from analyzer)
Required fast loop	2 m/s
Operating temperature	10 to 30 °C (50 to 86 °F); 5 to 95% relative humidity, non-condensing, non-corrosive
Storage temperature	-20 to 60 °C (-4 to 140 °F), ≤ 95% relative humidity, non-condensing
Sample temperature	65 °C (149 °F) maximum
Sample pressure	0.5 to 2 bar (3 bar maximum) (7.25 to 29 PSI, 43.5 PSI maximum)
Instrument air pressure (cleaning)	6 bar (50 psi)

¹ Regular maintenance and cleaning of the filter is necessary for a correct operation.

² With standard membrane, other membranes are available on request.

Specifications

Table 2 EZ9100 series, EZ-size heavy duty—Self-cleaning in-line filtration for difficult samples (continued)

Specification	Details
Rinse water	3/8" BSPF, 4 bar (58 PSI) maximum
Certifications	—
Warranty	USA: 1 year, EU: 2 years

Table 3 EZ9200 series, Microsize—Self-cleaning microfiltration system

Specification	Details
Dimensions (W x H x D)	600 × 1000 × 220 mm (23.62 × 39.37 × 8.66 in.)
Enclosure	IP55 optional (indoor installation)
Weight	15 kg (33 lb)
Material of filtration membrane	PES
Filtration pore size	0.04 µm
Power requirements	24 VDC (supplied from analyzer)
Power consumption	6 W
Electrical fuse protection	1 A
Operating temperature	5 to 55 °C (41 to 131 °F); 5 to 95% relative humidity, non-condensing, non-corrosive
Storage temperature	-20 to 60 °C (-4 to 140 °F), ≤ 95% relative humidity, non-condensing
Sample temperature	5 to 55 °C (41 to 131 °F)
Sample pH range	2 to 11 ³
Sample flow	±40 mL/min
Instrument air pressure (cleaning)	2 bar (29 psi)
Certifications	—
Warranty	USA: 1 year, EU: 2 years

³ With standard membrane, other membranes are available on request.

Section 3 General information

In no event will the manufacturer be liable for direct, indirect, special, incidental or consequential damages resulting from any defect or omission in this manual. The manufacturer reserves the right to make changes in this manual and the products it describes at any time, without notice or obligation. Revised editions are found on the manufacturer's website.

3.1 Safety information

NOTICE

The manufacturer is not responsible for any damages due to misapplication or misuse of this product including, without limitation, direct, incidental and consequential damages, and disclaims such damages to the full extent permitted under applicable law. The user is solely responsible to identify critical application risks and install appropriate mechanisms to protect processes during a possible equipment malfunction.

Please read this entire manual before unpacking, setting up or operating this equipment. Pay attention to all danger and caution statements. Failure to do so could result in serious injury to the operator or damage to the equipment.

Make sure that the protection provided by this equipment is not impaired. Do not use or install this equipment in any manner other than that specified in this manual.

3.1.1 Use of hazard information

⚠ DANGER

Indicates a potentially or imminently hazardous situation which, if not avoided, will result in death or serious injury.

⚠ WARNING

Indicates a potentially or imminently hazardous situation which, if not avoided, could result in death or serious injury.

⚠ CAUTION



Indicates a potentially hazardous situation that may result in minor or moderate injury.

NOTICE











Indicates a situation which, if not avoided, may cause damage to the instrument. Information that requires special emphasis.

3.1.2 Precautionary labels

Read all labels and tags attached to the instrument. Personal injury or damage to the instrument could occur if not observed. A symbol on the instrument is referenced in the manual with a precautionary statement.

	This is the safety alert symbol. Obey all safety messages that follow this symbol to avoid potential injury. If on the instrument, refer to the instruction manual for operation or safety information.
	This symbol indicates the need for protective eye wear.
	This symbol identifies a risk of chemical harm and indicates that only individuals qualified and trained to work with chemicals should handle chemicals or perform maintenance on chemical delivery systems associated with the equipment.

General information

	This symbol indicates that a risk of electrical shock and/or electrocution exists.
	This symbol indicates that the marked item can be hot and should not be touched without care.
	This symbol indicates that a risk of fire is present.
	This symbol identifies the presence of a strong corrosive or other hazardous substance and a risk of chemical harm. Only individuals qualified and trained to work with chemicals should handle chemicals or perform maintenance on chemical delivery systems associated with the equipment.
	This symbol indicates the presence of a harmful irritant.
	This symbol indicates that the marked item should not be touched.
	This symbol indicates a potential pinch hazard.
	This symbol indicates that the object is heavy.
	This symbol indicates the presence of devices sensitive to Electro-static Discharge (ESD) and indicates that care must be taken to prevent damage with the equipment.
	This symbol indicates that the marked item requires a protective earth connection. If the instrument is not supplied with a ground plug on a cord, make the protective earth connection to the protective conductor terminal.
	Electrical equipment marked with this symbol may not be disposed of in European domestic or public disposal systems. Return old or end-of-life equipment to the manufacturer for disposal at no charge to the user.

3.1.3 Chemical and biological safety

⚠ DANGER	
	Chemical or biological hazards. If this instrument is used to monitor a treatment process and/or chemical feed system for which there are regulatory limits and monitoring requirements related to public health, public safety, food or beverage manufacture or processing, it is the responsibility of the user of this instrument to know and abide by any applicable regulation and to have sufficient and appropriate mechanisms in place for compliance with applicable regulations in the event of malfunction of the instrument.
⚠ DANGER	
	Fire hazard. This product is not designed for use with flammable liquids.

3.2 Product overview

The sample preconditioning panels are used with the Hach EZ-series analyzers for measurement of water pollution, wastewater treatment and water purity. Sample preconditioning could be necessary based on the analysis technology. Sample preconditioning panels supply automatic sampling and sampling preconditioning (i.e., filtration, dilution, settling) to the Hach EZ-series analyzers. Refer to [Figure 1](#).

There are different sample preconditioning panels available:

- EZ9000 series: EZ -size—Self-cleaning in-line filtration system
- EZ9100 series: EZ-size heavy duty—Self-cleaning in-line filtration for difficult samples
- EZ9200 series: Microsize—Self-cleaning microfiltration system
- Moduplex: multi-channel options

Other preconditioning requirements are available on request (e.g., pressure, temperature, viscosity).

Figure 1 Scheme of a sample preconditioning system

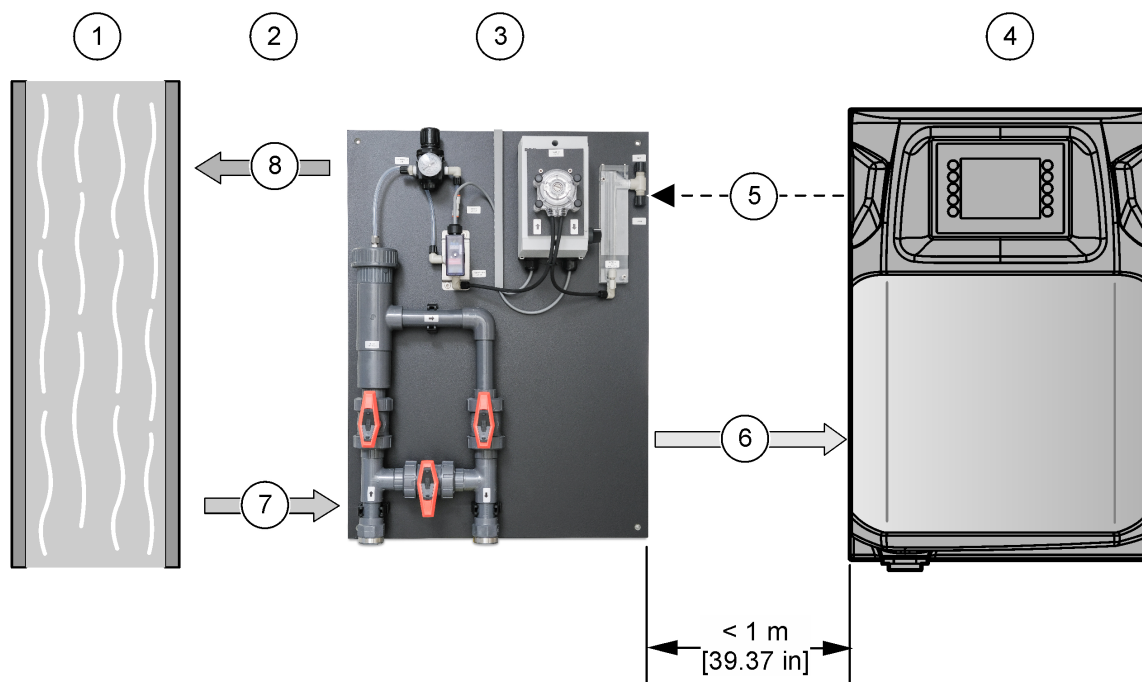

1 Process	4 EZ analyzer	7 Sample collection (SP: sample take-off point)
2 Fast loop	5 Control	8 Sample return (SRP: sample return point)
3 Sample preconditioning panel	6 Filtered/Treated sample	

3.2.1 Filtration—EZ-size

The filter is installed in a sample buffer unit connected by a fast loop with the sampling point. A peristaltic pump moves the filtered sample to a static pressure regulator. In between the pump and the filter, an automatic three way-valve blows back the filter at regular intervals to clean the filter. A drain-valve discards the contents of the overflow vessel. Refer to [Figure 2](#). As an option, the filter can be directly installed in a sample tank.

Typically the panel is controlled from the analyzer. As an alternative, the panel can be operated by a timer installed directly on the panel.

Figure 2 EZ-size filtration panel

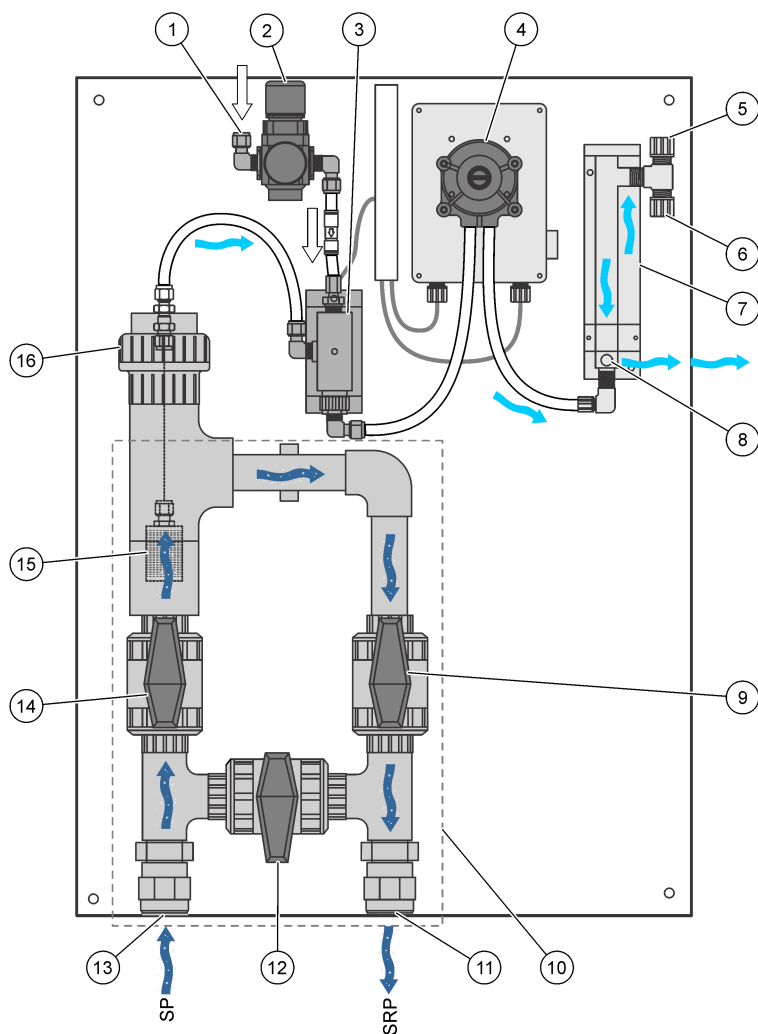

1 Instrument air	7 Overflow vessel	13 Sample in connection (Fast loop)
2 Pressure reducer	8 Filtered sample connection (to analyzer)	14 Manual sample in valve
3 Automatic three-way valve (automatic cleaning)	9 Manual sample out valve	15 Filter
4 Peristaltic pump	10 Fast loop	16 Clamp to remove filter
5 Overflow vent	11 Sample out connection (Fast loop)	
6 Overflow drain	12 Manual bypass valve	

3.2.2 Filtration—EZ-size heavy duty (anaerobic digestion)

The EZ-size heavy duty is a specific filtration system for digestate samples compatible with EZ series analyzers. Refer to [Figure 3](#). The filtration system is used in wet type samples from anaerobic digesters to make solid-free samples available for on-line analysis. The filtration panel is applicable for difficult samples, such as sludge and waste waters, charged with high levels of insoluble constituents. The primary properties of the filtration panel are:

- Self-cleaning sample filtration with various pore sizes
- Large-bore pneumatic ball valves for sample and drain
- Automatic cleaning with instrument air

- Analyzer controlled cleaning frequency
- Low maintenance

Figure 3 EZ-size heavy duty (anaerobic digestion) filtration panel

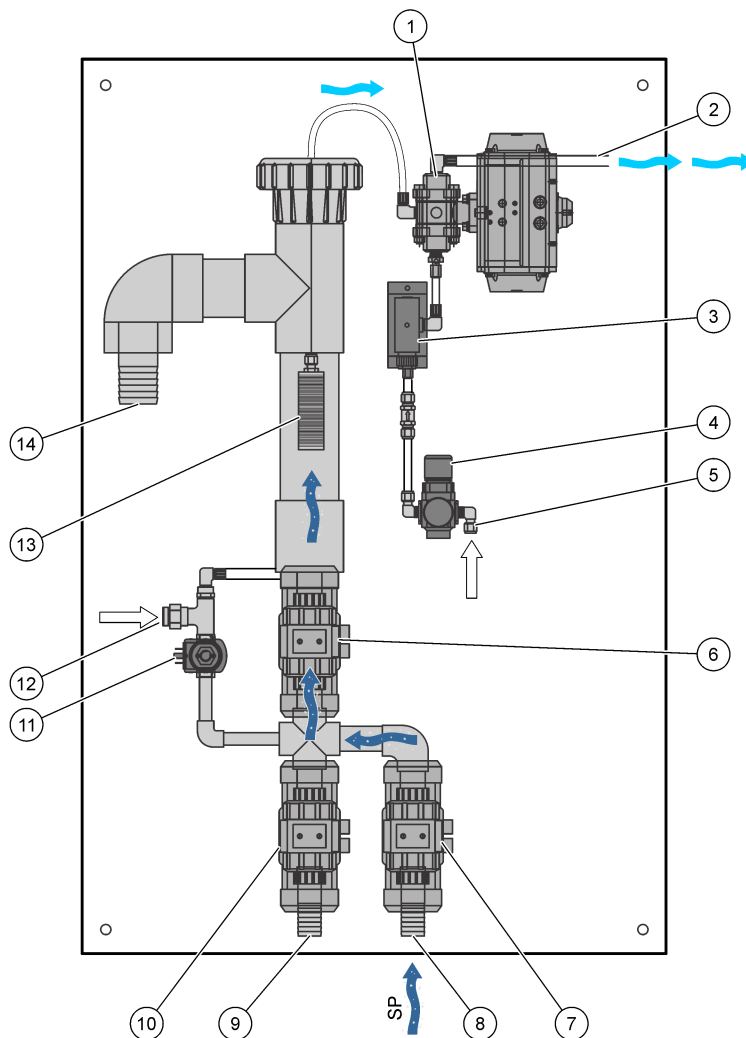

1 Three-way ball valve	6 Inlet valve	11 Rinse valve
2 Filtered sample connection (to analyzer)	7 Sample valve	12 Rinse water connection (to analyzer)
3 Automatic three-way valve (automatic cleaning)	8 Sample in connection (SP), 32 mm (1,25 in.) OD flexible tube	13 Filter
4 Pressure reducer	9 Drain connection, 32 mm (1,25 in.) OD flexible tube	14 Drain connection, 50 mm (1,97 in.) OD flexible tube
5 Instrument air	10 Drain valve	

3.2.3 Filtration—EZ-size heavy duty (wastewater)

The EZ-size heavy duty is a specific filtration system for wastewater difficult samples compatible with EZ series analyzers. Refer to [Figure 4](#). The filtration system is used in samples with high levels of insoluble constituents (e.g., wastewater) to make solid-free samples for on-line analysis. The primary properties of the filtration panel are:

- Self-cleaning sample filtration with various pore sizes
- Large-bore pneumatic ball valves for sample and drain
- Automatic cleaning with instrument air

General information

- Static pressure regulator for a constant, readily available sample level at atmospheric pressure
- Analyzer controlled cleaning frequency
- Low maintenance

Figure 4 EZ-size heavy duty (wastewater) filtration panel

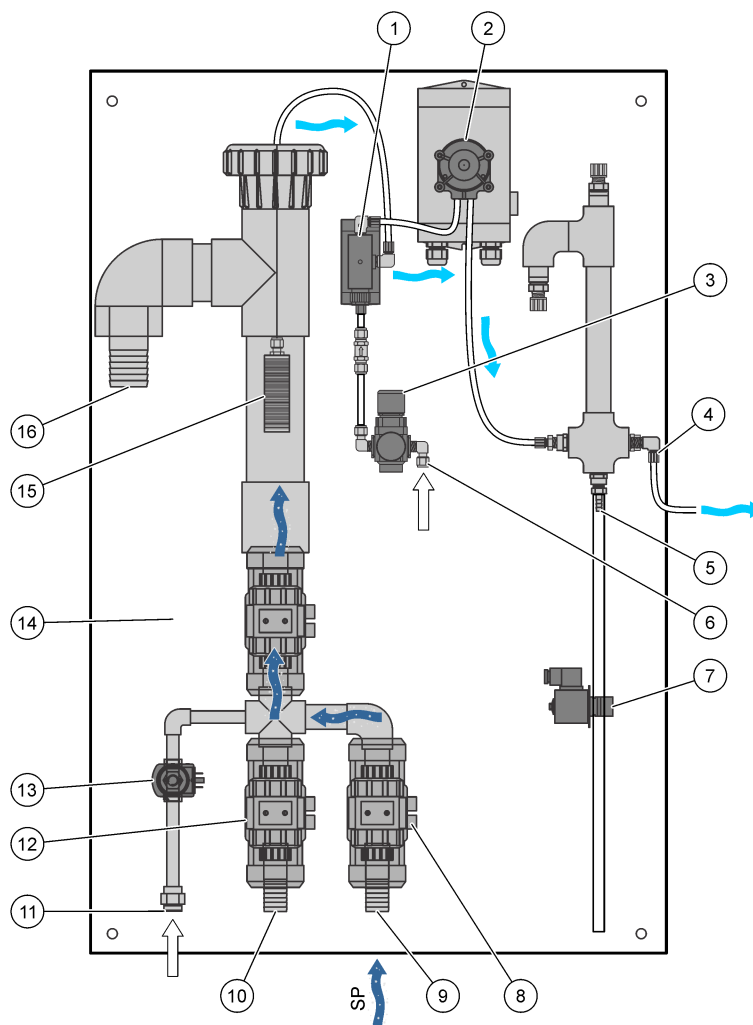

1 Air backflush valve	7 Drain valve	13 Rinse valve
2 Peristaltic pump	8 Sample valve	14 Inlet valve
3 Pressure reducer	9 Sample in connection (SP), 32 mm (1,25 in.) OD flexible tube	15 Filter
4 Filtered sample connection (to analyzer)	10 Drain connection, 32 mm (1,25 in.) OD flexible tube	16 Drain connection, 50 mm (1,97 in.) OD flexible tube
5 Drain connection, ¼ in. OD flexible tube	11 Ext rinse water connection	
6 Instrument air	12 Drain valve	

3.2.4 Microfiltration

The MicroSize filter is installed in a sample buffer unit connected by a fast loop with the sampling point. The filter has two membrane sheets installed on a frame and an aeration element. A peristaltic pump makes a negative pressure. The negative pressure moves the sample from the sample tank into the filter element and then to the overflow vessel.

The membranes removes solids larger than 0.04 µm. Refer to [Figure 5](#). As an alternative, the filter can be directly installed in a sample tank.

Note: If the filter is installed directly into the sample tank, make sure that the membranes are not kept dry for a long period. Crystallization of minerals in the membrane pores can occur and will significantly decrease the filtration function. Make sure that the filter is installed in a correct location (e.g., at a correct depth in the tank).

Compressed air flows continuously through the two aeration elements at the bottom of the filter, which causes turbulence on the surface of the membrane. The turbulence removes the solids and cleans the membrane surface.

Note: If the turbulence in the sample tank is high, the use of aeration could be useless. In some conditions, the use of aeration can cause precipitation on the surface of the filtration membrane and cause clogging of the membrane. In that condition, aeration must be set to off.

Figure 5 Microize filtration panel

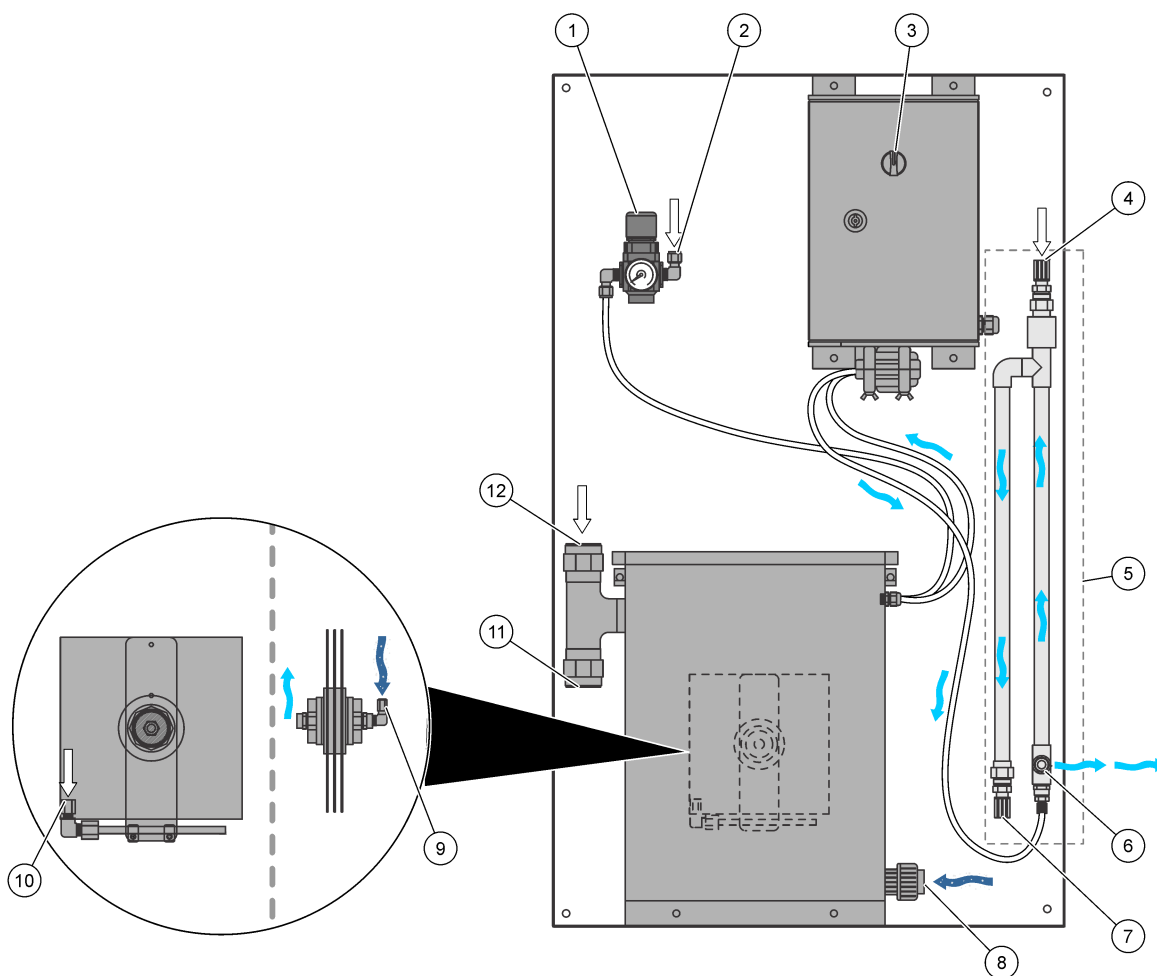

1 Pressure reducer	5 Overflow	9 Sample out connection (filter)
2 Instrument air	6 Filtered sample connection (to analyzer)	10 Air connection (filter)
3 Start/Stop switch	7 Overflow drain	11 Overflow
4 Overflow vent	8 Sample in connection	12 Vent

3.2.5 Moduplex—Multichannel option

The Moduplex is a device that connects between the sample preconditioning panel and the EZ analyzer and lets the system increase the sample lines. There are different versions and options available to connect a maximum of eight sample lines to the analyzer. For an example of two different Moduplex devices, refer to [Figure 6](#).

Figure 6 Examples of Moduplex panels

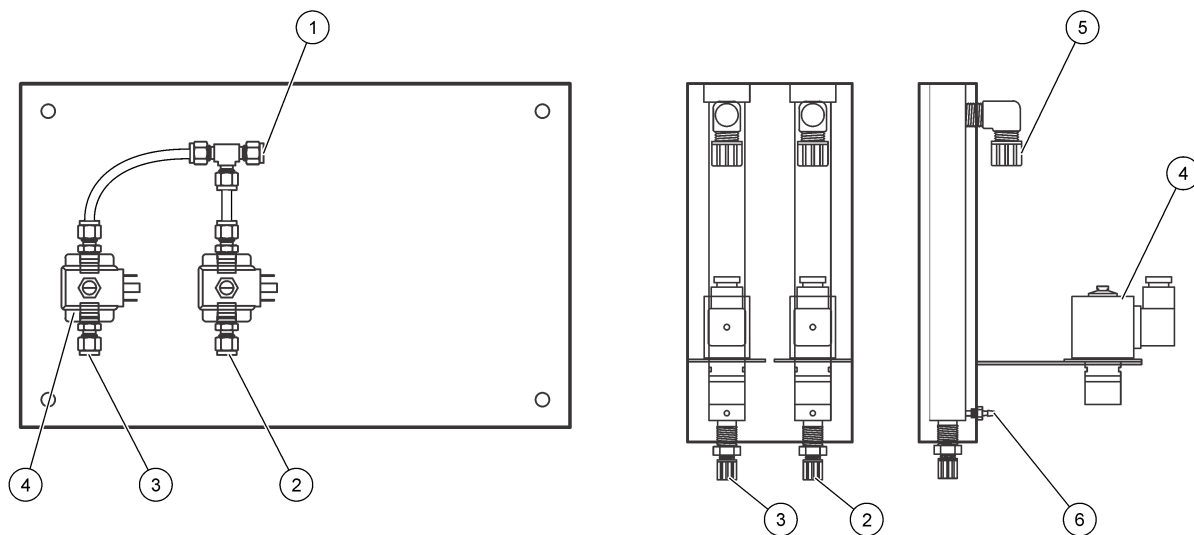

1 Sample connection to analyzer	3 Sample stream 2	5 Overflow
2 Sample stream 1	4 Stream-selection valves	6 Sample connection to analyzer (with pinch valve)

3.3 Product components

Make sure that all components have been received. Refer to the supplied documentation. If any items are missing or damaged, contact the manufacturer or a sales representative immediately.

Section 4 Installation

⚠ DANGER



Multiple hazards. Only qualified personnel must conduct the tasks described in this section of the document.

4.1 Installation guidelines

⚠ WARNING



Fire hazard. This product is not designed for use with flammable liquids.

- Install the panel indoors, in a non-hazardous environment.
- Install the panel as near to the analyzer as possible.
- Do not mount the panel in direct sunlight.
- Make sure to keep the temperature variation at minimum for a better measurement performance.
- Make sure that there is sufficient clearance to make plumbing and electrical connections.
- Make sure that the ambient conditions are within operating specifications. Refer to [Specifications](#) on page 5.
- If a positive sample pressure is necessary at the sample inlet of the analyzer (analyzers with a sample valve and no sample pump), install the analyzer below the sampling point of the overflow vessel to give a positive hydrostatic pressure.

4.2 Attach the instrument to a wall

⚠ WARNING



Personal injury hazard. Make sure that the wall mounting is able to hold 4 times the weight of the equipment.

⚠ WARNING



Personal injury hazard. Instruments or components are heavy. Use assistance to install or move.

Attach the instrument upright and level on a flat, vertical surface. The panel has four 9 mm holes for wall mounting. Refer to the illustrated steps that follow.

Note: *Wall mounting hardware is supplied by the user. Screws/fittings must be suitable for the wall/ceiling properties and possess sufficient bearing capacity.*

- EZ-size: W = 460 mm (18.11 in.); H = 1130 mm (44.49 in.)
- Microsize: W = 560 mm (22.05 in.); H = 960 mm (37.79 in.)

Installation

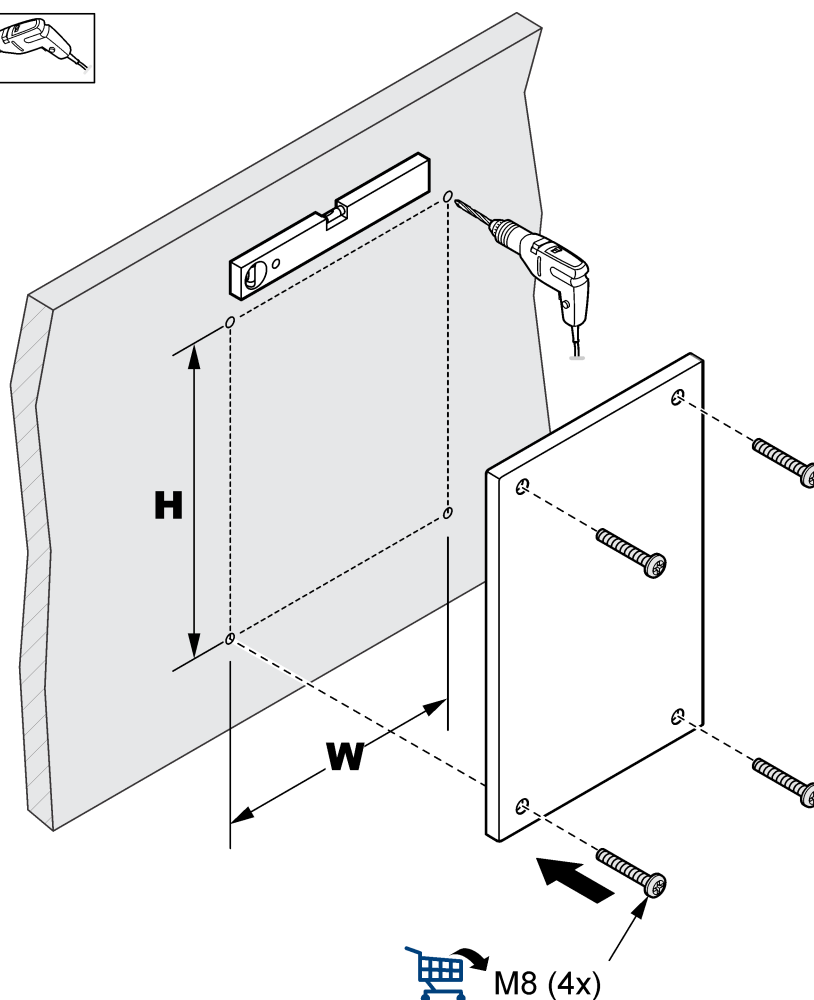
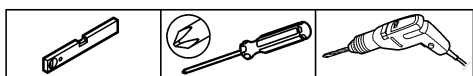

4.3 Electrical installation

⚠ DANGER	
	Multiple hazards. Only qualified personnel must conduct the tasks described in this section of the document.

⚠ DANGER	
	Electrocution hazard. Always remove power to the instrument before making electrical connections.

Use the supplied cable to connect the 24 VDC power supply for the timer to the analyzer. Refer to the analyzer documentation. As an alternative, if the timer is used to operate the panel, supply power to the timer. Refer to [Program the timer](#) on page 22.

4.4 Plumb the panel

⚠ CAUTION	
	Chemical exposure hazard. Dispose of chemicals and wastes in accordance with local, regional and national regulations.

Make sure that the sample inlet agrees with the sample requirements. Refer to [Specifications](#) on page 5.

Note: If the sample is not stable (i.e., precipitation reactions occur) increase the frequency of the maintenance tasks for a correct operation of the filtration system.

Use the drain connections to discard the excess of sample. Make sure that the drain capacity is higher than the sample flow through the filtration panel (the recommended drain capacity is the sample flow multiplied by two). Make sure that the drain lines are open to air and are at zero pressure. A vent connection open to air and at zero pressure is necessary for the overflow vessel.

Instrument air is necessary for the automatic cleaning of the panel. Pressure settings for the instrument air must be higher than pressure of the sample. Refer to [Specifications](#) on page 5. If necessary, flush the filtration panel with clean water (tap water or effluent water) to remove solids buildups. Refer to [Maintenance](#) on page 23

Refer to [Product overview](#) on page 9 to find the plumbing connections.

4.4.1 EZ-size connections

1. Use 1-in. BSP OD tube to plumb the sample inlet and outlet tubing of the fast loop.
2. Use 1/4-in. Perfluoroalkoxy (PFA) or Polyethylene (PE) OD tube to plumb the sample to the filter.
3. Connect the drain:
 - a. Use 1-in. BSP OD tube to plumb the drain for the sample return of the fast loop.
 - b. Use a 3/8-in. male connector and 3/8-in. OD tube to plumb the drain for the overflow vessel of the filtered sample.
4. Use a 3/8-in. male connector and 3/8-in. OD tube to plumb the vent connection of the overflow vessel.
5. Use 1/4-in. PFA or PE OD tubing to connect the instrument air.

Note: Pressure inlet must be 6 bar. A pressure reducer installed on the filtration panel decreases the pressure to approximately 3 bar.
6. Use 1-in. BSP OD tube to plumb the rinse water into the sample inlet fast loop (optional).

4.4.2 Microsize connections

1. Use 1/2-in. F BSP OD tube to plumb the sample inlet to the panel.
2. Use 1/8-in. PFA or PE OD tube to plumb the sample to the filter.
3. Use 1/4-in. PFA or PE OD tube to plumb the vent connection on the filter.
4. Connect the drain:
 - a. Use 1-in. BSP OD tube to plumb the drain for the sample return of the fast loop.
 - b. Use a 3/8-in. male connector and 3/8-in. OD tube to plumb the drain for the overflow vessel of the filtered sample.
5. Use a 3/8-in. male connector and 3/8-in. OD tube to plumb the vent connection of the overflow vessel.
6. Use 1/4-in. PFA or PE OD tubing to connect the instrument air.

Note: Pressure inlet must be 6 bar. A pressure reducer installed on the filtration panel decreases the pressure to approximately 3 bar.
7. Use 1-in. BSP OD tube to plumb the vent and the overflow.

Section 5 Startup

Put on the personal protective equipment identified in the safety data sheet (MSDS/SDS). Do the steps that follow to complete the initial startup of the panel.

1. Make sure that all of the plumbing and tubing connections are complete.
2. Close the instrument air valve.
3. Close the drain valve.
4. Close the bypass valve.
5. Open the sample in valve.
6. Open the sample out valve.
7. Examine all of the drain connections. Make sure that drain connections are open and open to air.
8. Open the valve (customer side) for the sample to the filtration unit.
9. If sample is flowing through the loop of the filtration unit, slightly close the sample out valve to get a pressure of 0.1 bar.
10. Open the pressure of the instrument air and set the pressure to 1 bar.
11. Examine the filtered sample flow.

Section 6 Operation

⚠ WARNING

Fire hazard. This product is not designed for use with flammable liquids.

6.1 Set valves and pressures

During standard operation, the bypass valve and the drain valve of the fast loop are closed. The sample in valve is fully open and the sample out valve is slightly closed. Refer to [Figure 7](#) and [Table 4](#) for the valve settings during different operation conditions.

Pressure reading on the pressure indicator must be as high as 0.1 bar. This pressure makes a high sample flow that prevents the collection of solids (based on the application) and the growth of algae and bacteria in the overflow vessel (wash out is too high). If solids in the overflow vessel collects and clogs the sample tubing, increase the pressure on the filter to increase the filtered sample flow. The pressure for the instrument air for the cleaning of the filter must be minimum five times higher than the pressure reading. Normal setting of the instrument air is 3 bar.

Figure 7 Valve settings

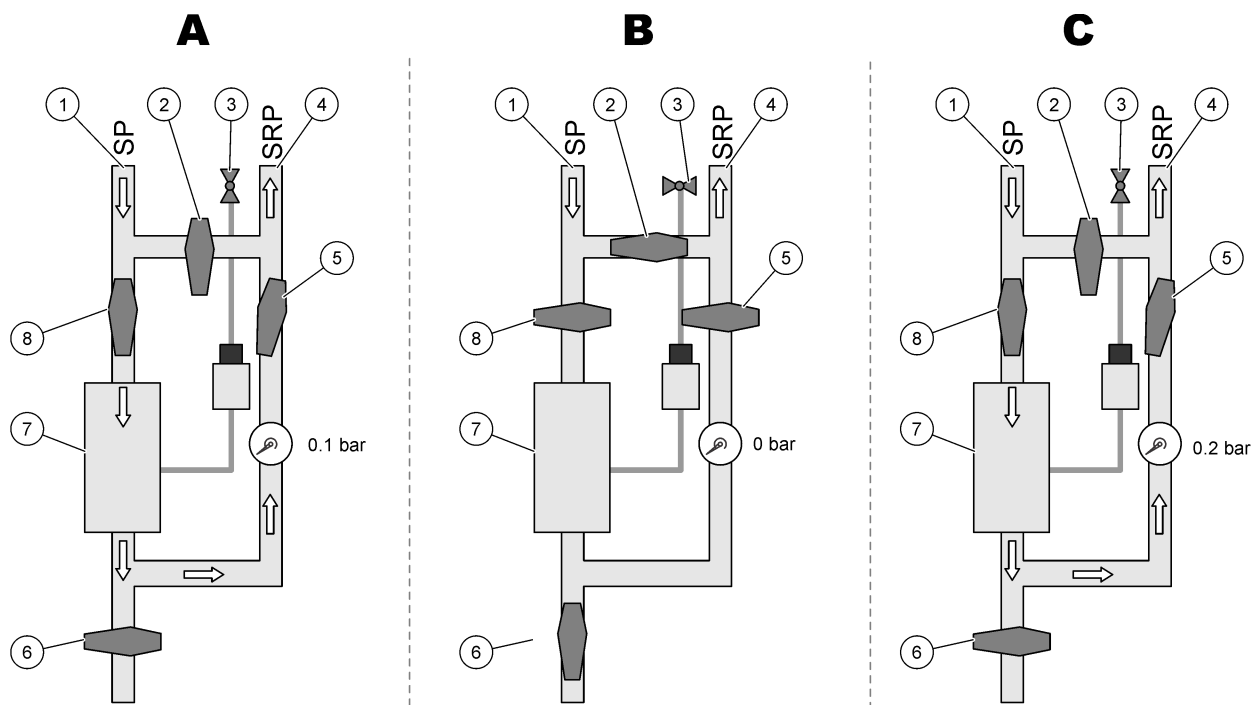

1 Sample out connection (Fast loop)	4 Sample in connection (Fast loop)	7 Filter
2 Manual bypass valve	5 Manual sample in valve	8 Manual sample out valve
3 Instrument air	6 Drain valve	

Table 4 Valve settings—Positions

Operation	A: Normal	B: Maintenance	C: Flush with water	Shutdown
Sample valve (customer)	Open	Open	Open	Closed
Sample in valve	Open	Closed	Open	
Sample out valve	Slightly closed	Closed	Slightly closed	

Table 4 Valve settings—Positions (continued)

Operation	A: Normal	B: Maintenance	C: Flush with water	Shutdown
Bypass valve	Closed	Open	Closed	
Drain valve	Closed	Open	Closed	

6.2 Program the timer

As an alternative, the panel can be operated by a timer installed directly on the panel. The timer is located on the sample valve. Do the steps that follow to change the timer settings.

1. Remove the cover screws to get access to the switches.
2. Change the switches to set the timer. The default settings for the filtration is cleaning each 10 minutes. Refer to [Figure 8](#).



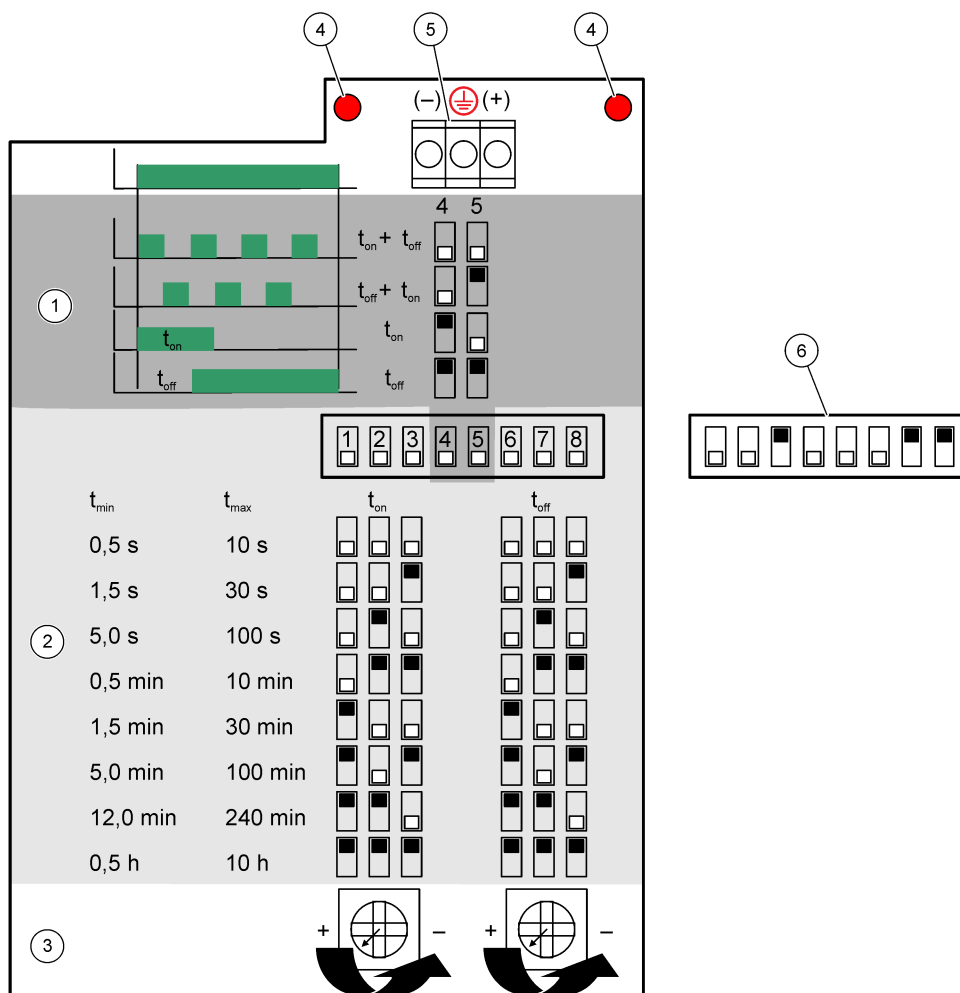

Figure 8 Program the timer



1 Function selection	3 Time setting ⁴	5 Main power connection (AC/DC)
2 Selection of time range	4 Power LED	6 Default switch setting

⁴ Adjust to get a time setting between $t_{min}(-)$ and $t_{max}(+)$

Section 7 Maintenance

⚠ CAUTION	
	Multiple hazards. Only qualified personnel must conduct the tasks described in this section of the document.
⚠ CAUTION	
 	Chemical exposure hazard. Obey laboratory safety procedures and wear all of the personal protective equipment appropriate to the chemicals that are handled. Refer to the current safety data sheets (MSDS/SDS) for safety protocols.
⚠ CAUTION	
	Chemical exposure hazard. Dispose of chemicals and wastes in accordance with local, regional and national regulations.

7.1 Maintenance schedule

Table 5 shows the recommended schedule of maintenance tasks. Facility requirements and operating conditions may increase the frequency of some tasks.

Table 5 Maintenance schedule

Task	1 day	7 days	30 days	90 days	365 days	As necessary
Examine for leaks and malfunctions on page 23	X					X
Examine the pressure on page 23	X					X
Rinse the panel with water on page 23			X			
Clean and replace the filter on page 24				X		
Replace tubing (optional if contamination forms on the wall of the tubing)					X	
Replace peristaltic pump tubing (if applicable)				X		
Replace pinch valve tubing (if applicable)				X		

7.2 Examine for leaks and malfunctions

1. Examine all of the components in the panel, the connectors and tubings for leaks and corrosion. Make sure that the connections are tight and with no leaks.
2. Examine all of the cables and tubing for physical damage. Replace if necessary.
3. Examine the air pressure connection. Make sure the air pressure is correct.



7.3 Examine the pressure

Examine the pressure reading. Make sure that the pressure agrees with the levels at [Specifications](#) on page 5.

7.4 Rinse the panel with water

Use tap water or effluent water to flush the filtration panel and remove contamination and solids from the panel. Refer to [Set valves and pressures](#) on page 21.

7.5 Clean and replace the filter

⚠ DANGER	
	Chemical exposure hazard. Obey laboratory safety procedures and wear all of the personal protective equipment appropriate to the chemicals that are handled. Refer to the current safety data sheets (MSDS/SDS) for safety protocols.
⚠ DANGER	
	Chemical exposure hazard. Acids used for the cleaning are corrosive. Make sure to wear the appropriate personal protective equipment if acids are used for cleaning.

Before cleaning or replacing the filter element, check if the manual valves for the sample loop are closed. Also check the chemical and physical safety of the wastewater inside the filter element. Use protective clothing, goggles and gloves while replacing the filter element.

1. Set the instrument air off.
2. Set the pump off.
3. Open the bypass valve.
4. Close the sample in and sample out valves (fast loop)
5. Open the drain valve to remove the water in the filter.
6. Open the filter holder.
7. Remove the filter.
8. Clean the filter.
 - a. **EZ-size and Microsize:** Use water and a sponge to clean the membranes on the filter.

Note: If necessary, increase the maintenance frequency and clean the filter with acid. Use a solution of citric (20%) acid to clean outer side of the membranes. Flow a solution of 0.2% citric acid through the filter (n) to clean the membrane.
9. Install the filter back in the filter holder. If necessary, install a new filter. Make sure that the O-rings and the green rubber sealing are correctly installed.
10. Open the valves to the correct position.
11. Set the instrument air to on.

7.6 Replace the sample pump tubing (EZ-size and Microsize only)

Replace the Norprene[®] tubing in the pump head at four months intervals.

1. Stop the pump.
2. Remove the 4 pump head screws.
3. Open the pump head.
4. Replace the tubing. Make sure to use the same size.
5. Close the pump head and turn the rotor before connecting the pump head to the pump.

7.7 Clean the drain piping

Make sure that the external drain piping does not have a blockage. Clean if necessary.

7.8 Replace the peristaltic pump tubing

The peristaltic pump is used to:

- Drain and rinse the analysis vessel.
- Add the cleaning and validation solution and the sample.
- Remove the excess of sample when used as a leveling system.

The peristaltic pump has a motor and a peristaltic pump head. Replace the peristaltic pump tubing regularly for the best analyzer performance. Refer to the illustrated steps that follow.

Note: When the procedure is complete, set the pump to on to make sure the pump operates correctly.

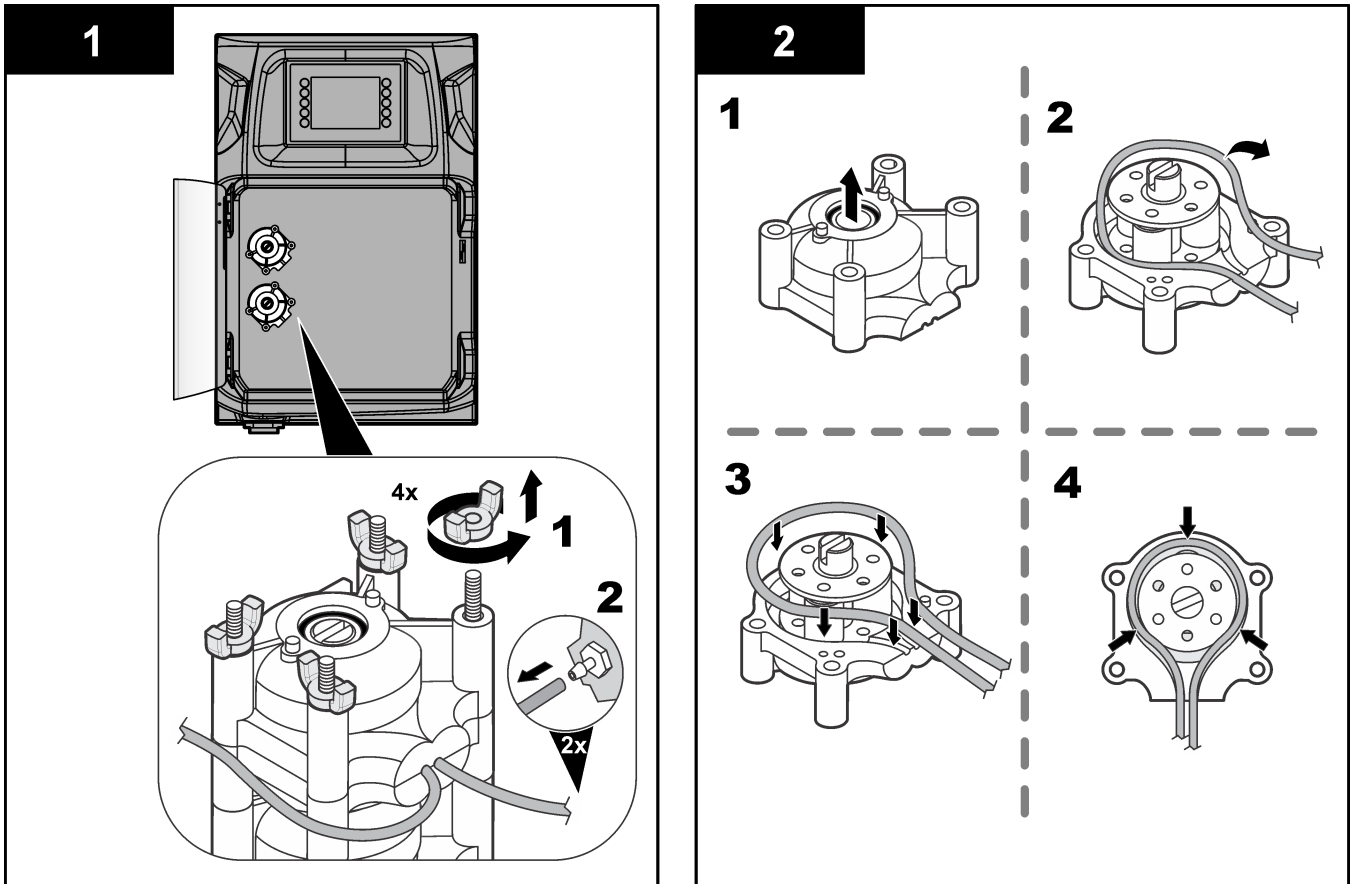

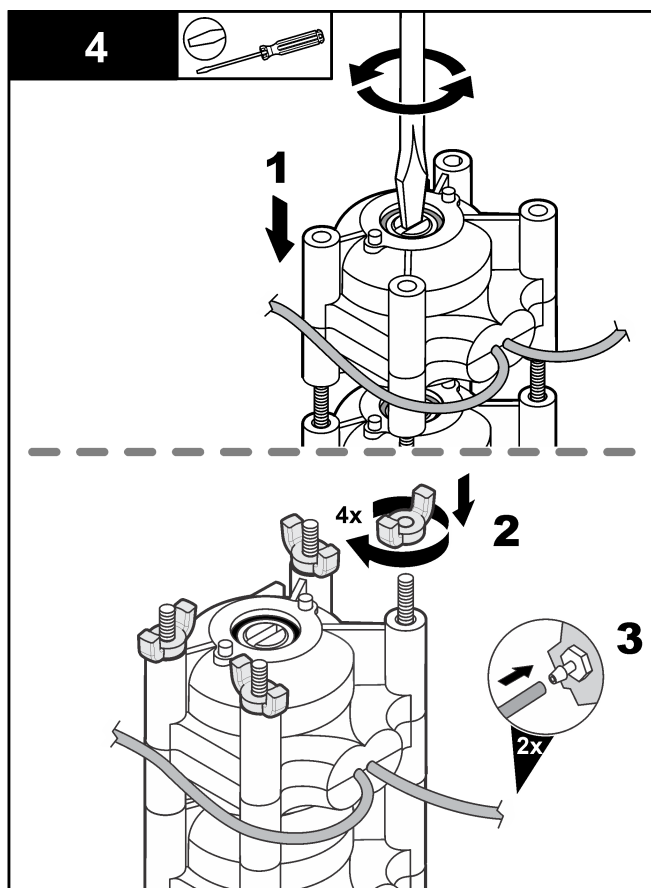
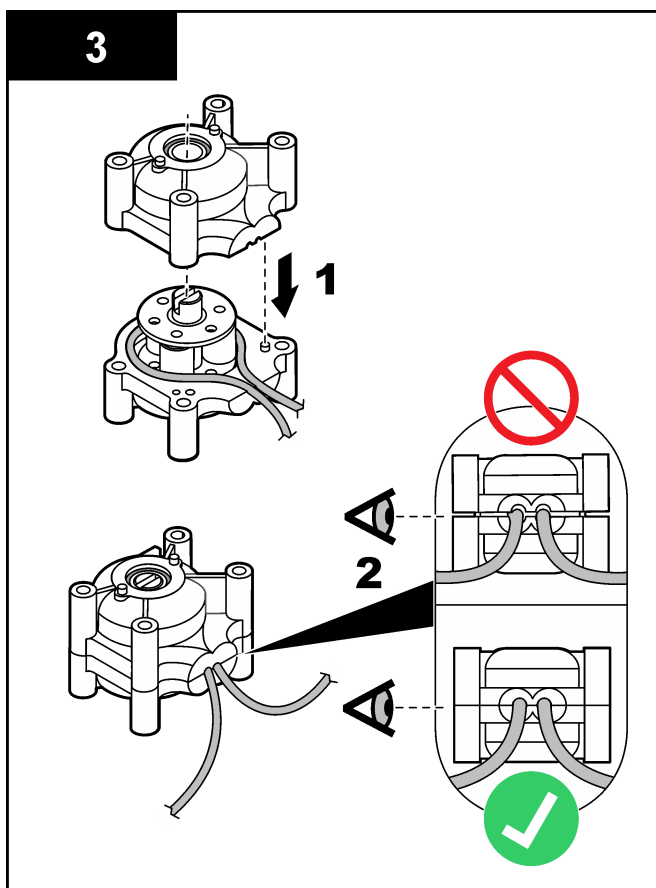

7.9 Shut down the panel

Before shut down the sample preconditioning panel, fully flush the system with clean water (tap water). Refer to [Set valves and pressures](#) on page 21.

Section 8 Replacement parts and accessories

⚠ WARNING



Personal injury hazard. Use of non-approved parts may cause personal injury, damage to the instrument or equipment malfunction. The replacement parts in this section are approved by the manufacturer.

Note: Product and Article numbers may vary for some selling regions. Contact the appropriate distributor or refer to the company website for contact information.

Refer to the manufacturer's website to find the replacement parts and accessories based on the analyzer part number.

Replacement parts





Description	Quantity	Item no.
Pinch-valve NC, ID 4.8 mm OD 7.9 mm, 24 VDC	each	APPAA0010001
Motor fixed speed 96 rpm, 24 VDC	each	APPAZ0000411
Motor fixed speed 48 rpm, 24 VDC	each	APPAZ0000410
Pump head size 17	each	APPAB0011305
Pump head size 16	each	APPAB0011200
Tubing size 16, Norprene	15 m	APPAB0011600
Tubing size 17, Norprene	15 m	APPAB0011905
Tubing pinch-valve ID 4.8 mm OD 7.9 mm	15 m	APPAO0001700
3WV 24Vdc,PP,FKM,4bar,80°C,1/4"G	each	APPAA0000600
Dispenser/6000, 25 mL	each	APPAZ0017200
Valve/24000/6000/1000	each	APPAI0000300
Syringe/6000, 25 mL	each	APPAI0000700
Air reducer, 0.3 to 10 bar, 1/4	each	APPAH0010010
EZ-Size/2 filter element, 50 µm 50 mm, SS316L	each	APPAZ0060004
EZ-Size/2 filter element, 100 µm 50 mm, SS316L	each	APPAZ0060005
EZ-Size/2 filter element, 200 µm 50 mm, SS316L	each	APPAZ0060006
EZ-Size/2 filter element, 500 µm 50 mm, SS316L	each	APPAZ0060007
EZ-Size/2 filter element, 1000 µm 50 mm, SS316L	each	APPAZ0060008
EZ-Size/2 filter element, 100 µm 90 mm, SS316L	each	APPAZ0060115
EZ-Size/2 filter element, 200 µm 90 mm, SS316L	each	APPAZ0060116
EZ-Size/2 filter element, 500 µm 90 mm, SS316L	each	APPAZ0060117
EZ-Size/2 filter element, 1000 µm 90 mm, SS316L	each	APPAZ0060118
Filter, ID 32 mm L 34 cm, 10 µm	each	APPAT0000100
Filter, ID 32 mm L 34 cm, 50 µm	each	APPAT0000105
Filter, ID 32 mm L 34 cm, 100 µm	each	APPAT0000200
Filter, ID 32 mm L 34 cm, 200 µm	each	APPAT0000300
Filter, ID 32 mm L 34 cm, 1000 µm	each	APPAT0000301
Filter, ID 32 mm L 34 cm, 2000 µm	each	APPAT0000302
Filter, ID 32 mm L 34 cm, 2 mm 0.1 mm	each	APPAT0000303
O-ring VITON 40×1.5mm	each	APPAP0000200

Replacement parts and accessories





Replacement parts (continued)

Description	Quantity	Item no.
Tubing, 1/8"OD, PFA	15 m	APPAA0000200
PFA Tubing 1/4"OD	15 m	APPAA0000300
PE tubing 1/4"OD,	15 m	APPAA0001600
Microsize membrane module	each	APPAT0000800
Aeration tube, OD 10.1 mm ID 4.5 mm, PTFE	each	APPAT0000500
Microsize membrane module	each	APPAZ0060020
MC NPT1/4" - TUBE 1/8"OD	each	APPAN0054005
T 3/8"NPT - 2 x tube 3/8" OD PP	each	APPAN0056305
MC NPT1/4" - TUBE 1/4"OD PP	each	APPAN0055005
MC NPT1/8" - TUBE 1/8"OD	each	APPAN0054000
2W PnV PFA, NC, 1/4"	each	APPAA0000620
3W BallV , SS, 1/4"NPT F	each	APPAA0000608
Timer for valve 24 VDC	each	APPAA0000700
Overflow vessel, 1 stream, D20 60 mL, PMMA	each	APPAJ0010321
2WV 3/8" 24Vdc / 9w	each	APPAA0000630

Accessories

Description	Item no.	Image
External rinse valve or backflush valve, 3-way valve, PP, FKM, 4 bar, 80 °C, 1/4"G, 24 VDC	APLA0000600	
External rinse valve, 2-way valve, 3/8", 9 W, 24 VDC	APLA0000630	
Timer module, 24 VDC (used with APLA0000600 for automatic backflush procedures)	APLA0000700	
Pinch valve, drain function of overflow vessell, NC, ID 4.8 mm, OD 7.9 mm, 24 VDC	APLA0010001	

Replacement parts and accessories

Description	Item no.	Image
Pinch valve, multi stream options, NC, ID 1.57 mm, OD 3.2 mm, 24 VDC	APLA0010115	
Filtration pump motor, 6 W, 1200 rpm. 24 VDC	APLB0010101	
Stirrer assembly 8x105 H70 D22-19 , external stirrer plate (different variations in number and position are possible)	APLZ0006311	
ZeroCarb system, 24 VDC, CO ₂ and moisture removal for instrument air	APLH0001200	

HACH COMPANY World Headquarters

P.O. Box 389, Loveland, CO 80539-0389 U.S.A.
Tel. (970) 669-3050
(800) 227-4224 (U.S.A. only)
Fax (970) 669-2932
orders@hach.com
www.hach.com

HACH LANGE GMBH

Willstätterstraße 11
D-40549 Düsseldorf, Germany
Tel. +49 (0) 2 11 52 88-320
Fax +49 (0) 2 11 52 88-210
info-de@hach.com
www.de.hach.com

HACH LANGE Sàrl

6, route de Compois
1222 Vérenaz
SWITZERLAND
Tel. +41 22 594 6400
Fax +41 22 594 6499

