



Method 8180

PhosVer 3 with Acid Hydrolysis

(0.00 to 5.00 mg/L PO₄³⁻)

Test 'N Tube™ Vials

(0.00 to 1.60 mg/L P)

Scope and Application: For water, wastewater and seawater.

The estimated detection limit for program number 3037 is 0.17 mg/L PO₄³⁻.

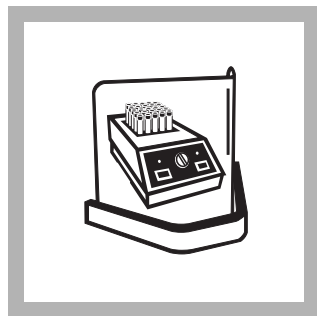

1. Turn on the COD Reactor. Heat to 150 °C. Place the plastic shield in front of the reactor.

Note: Ensure safety devices are in place to protect the analyst from splattering should leakage occur.

Note: See COD Reactor Manual for temperature adjustment instructions.

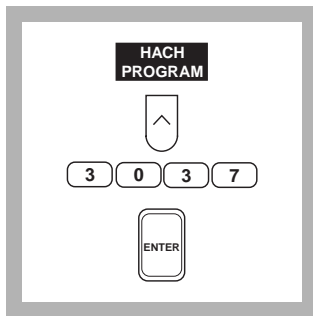

2. Press the soft key under **HACH PROGRAM**. Select the stored program for acid hydrolyzable phosphorus by pressing **3037** with the numeric keys.

Press: **ENTER**

Note: If samples cannot be analyzed immediately, see Sample Collection, Storage and Preservation following these steps.



3. The display will show: **HACH PROGRAM: 3037 P A-H As. TNT**

The wavelength (λ), **890 nm**, is automatically selected.

Note: Clean glassware with 1:1 Hydrochloric Acid Standard Solution. Rinse with deionized water. Do not use phosphate detergents to clean glassware.

Note: For best results, determine a reagent blank for each new lot of reagent as follows. Prepare a reagent blank by repeating steps 4 through 21, using deionized water as the sample. Zero the instrument on deionized water by pressing the soft key under **ZERO**. Insert the reagent blank and the blank value will be displayed. Correct for the reagent blank by pressing the soft keys under **OPTIONS**, **(MORE)**, and then **BLANK: OFF**. Enter the reagent blank value and press **ENTER**. Repeat for each new lot of reagent.

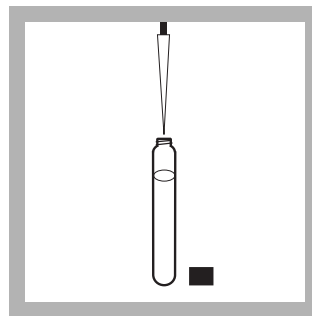

4. Use a TenSette Pipet to add 5 mL of sample to a Total and Acid Hydrolyzable Test Vial. Cap and mix.

Note: For proof of accuracy, use a 1.0-mg/L Phosphate (0.33-mg/L P) Standard Solution in place of the sample (see **OPTIONAL REAGENTS AND STANDARDS**).

Note: For non-preserved samples with extreme pH.

PHOSPHORUS, Acid Hydrolyzable, continued

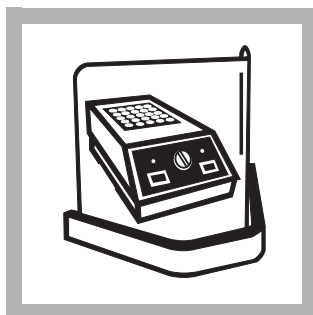

5. Place the vial in the COD Reactor, and start a 30-minute heating period by pressing the soft key under **START TIMER**.

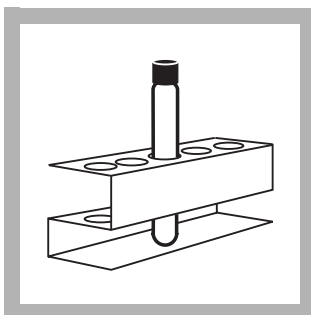

6. After the timer beeps, carefully remove the vial from the reactor. Place it in a test tube rack and allow to cool to room temperature.

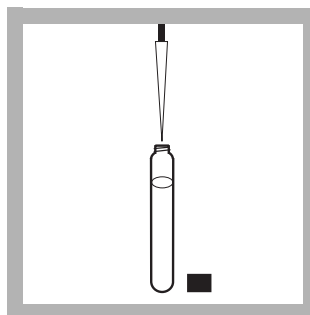

7. Using a TenSette Pipet, add 2 mL of 1.00 N Sodium Hydroxide to the vial. Cap tightly and shake to mix.



8. Insert the Test Tube Adapter into the sample cell module by sliding it under the thumb screw and into the alignment grooves. Fasten with the thumb screw.



9. Clean the outside of the vial with a towel.

Note: Wiping with a damp towel, followed by a dry one, will remove fingerprints or other marks.



10. Place the sample vial in the cell holder and close the light shield.

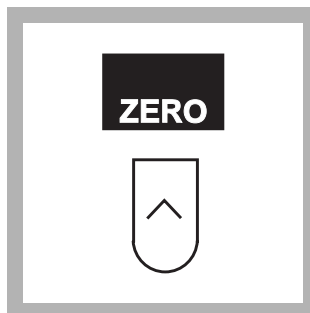

11. Press the soft key under **ZERO**.

The display will show:

0.00 mg/L PO₄³⁻

Note: If you are using a reagent blank correction, the display will show the correction.

*Note: For alternate concentration units, press the soft key under **OPTIONS**. Then press the soft key under **UNITS** to scroll through the available options. Press **ENTER** to return to the read screen.*

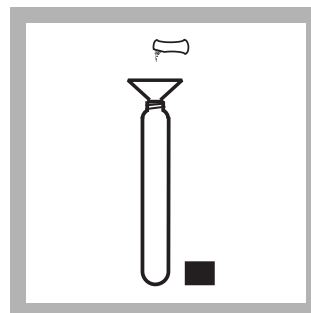

12. Using a funnel, add the contents of one PhosVer 3 Powder Pillow to the vial.

PHOSPHORUS, Acid Hydrolyzable, continued

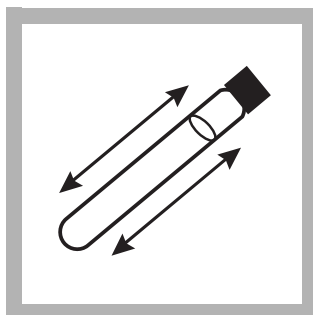

13. Cap tightly and shake to mix for 10-15 seconds.

Note: The powder will not completely dissolve.

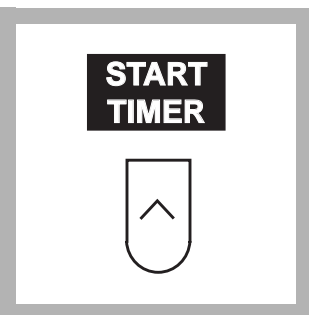

14. Press the soft key under **START TIMER**.

A 2-minute reaction period will begin.



15. Clean the outside of the sample vial with a towel.

Note: Wiping with a damp towel, followed by a dry one, will remove fingerprints or other marks.

Note: Read the samples 2-8 minutes after the addition of the PhosVer 3 Reagent.

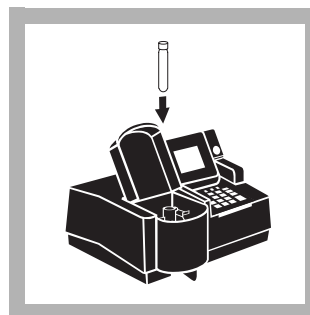

16. Place the prepared sample vial into the cell holder and close the light shield. Results in mg/L PO_4^{3-} (or chosen units) will be displayed.

Note: Results may be expressed as phosphorus (P) or as phosphorus pentoxide (P_2O_5). Press the soft keys under **OPTIONS** and then **FORM**: to scroll through the available options.

Interferences

Interfering Substance	Interference Levels and Treatments
Aluminum	Greater than 200 mg/L
Arsenate	All levels
Chromium	Greater than 100 mg/L
Copper	Greater than 10 mg/L
Iron	Greater than 100 mg/L
Nickel	Greater than 300 mg/L
Silica	Greater than 50 mg/L
Silicate	Greater than 10 mg/L
Sulfide	Greater than 9 mg/L. Remove sulfide interference as follows: <ol style="list-style-type: none"> 1. Measure 25 mL of sample into a 50-mL beaker. 2. Swirling constantly, add Bromine Water drop-wise until a permanent yellow color appears. 3. Swirling constantly, add Phenol Solution drop-wise just until the yellow color disappears. Proceed with step 1.
Turbidity	Large amounts may cause inconsistent results in the test because the acid present in the powder pillows may dissolve some of the suspended particles and because of variable desorption of orthophosphate from the particles.
Zinc	Greater than 80 mg/L
Highly buffered samples or extreme sample pH	May exceed the buffering capacity of the reagents and require sample pretreatment

Store the PhosVer 3 Phosphate Reagent Powder Pillows in a cool, dry environment.

Sample Collection, Storage and Preservation

Collect samples in plastic or glass bottles that have been acid washed with 1:1 Hydrochloric Acid Solution and rinsed with deionized water. Do not use commercial detergents containing phosphate for cleaning glassware used in this test.

Analyze samples immediately after collection for best results. If prompt analysis is impossible, preserve samples up to 24 hours by storing at 4 °C. Warm samples to room temperature before analysis.

Accuracy Check

Standard Additions Method

- a. Leave the unspiked sample in the sample compartment. Verify that the units displayed are in mg/L. Select standard additions mode by pressing the soft keys under **OPTIONS, (MORE)** and then **STD ADD**.
- b. Press **ENTER** to accept the default sample volume (mL), 25.
- c. Press **50.0** to change the standard concentration to (mg/L), 50.0. Then press **ENTER**.
- d. Press the soft key under **ENTRY DONE**.
- e. Snap the neck off a Phosphate 2-mL Ampule Standard, 50-mg/L as PO_4^{3-} .
- f. Use the TenSette Pipet to add 0.1 mL, 0.2 mL and 0.3 mL of standard, respectively to three 25-mL samples and mix each thoroughly.
- g. Analyze each standard addition sample as described above (use a 5-mL aliquot of the spiked sample as the sample). Accept the standard additions reading by pressing the soft key under **READ** each time. Each addition should reflect approximately 100% recovery.
- h. After completing the sequence, the display will show the extrapolated concentration value and the “best-fit” line through the standard additions data points, accounting for matrix interferences.
- i. See Section 1.4.1 *Standard Additions* for more information.

Method Performance

Precision

Standard: 3.00 mg/L PO_4^{3-}

Program	95% Confidence Limits
3037	2.96–3.04 mg/L PO_4^{3-}

For more information on determining precision data and method detection limits, refer to Section 1.5.

Estimated Detection Limit

Program	EDL
3037	0.07 mg/L PO ₄ ³⁻

For more information on derivation and use of Hach's estimated detection limit, see Section 1.5.2. To determine a method detection limit (MDL) as defined by the 40 CFR part 136, appendix B, see Section 1.5.1.

Sensitivity

Program Number: 3037

Portion of Curve	ΔAbs	ΔConcentration
Entire Range	0.010	0.061 mg/L

See Section 1.5.3 *Sensitivity Explained* for more information.

Calibration Standard Preparation

To perform a phosphate calibration using the Test 'N Tube method, prepare calibration standards containing 1.00, 2.00, 3.00, 4.00, and 5.00 mg/L phosphate as follows:

- a. Into five different 100-mL Class A volumetric flasks, pipet 2.00, 4.00, 6.00, 8.00 and 10.00 mL of a 50-mg/L Phosphate Standard Solution (Cat. No. 171-49) using Class A glassware.
- b. Dilute to the mark with deionized water. Mix thoroughly.
- c. Using the Test 'N Tube method and the calibration procedure described in the *User-Entered Programs* section of the *DR/4000 Spectrophotometer Instrument Manual*, generate a calibration curve from the standards prepared above.

Summary of Method

Phosphates present in condensed inorganic forms (meta-, pyro-, or other polyphosphates) must be converted to reactive orthophosphate before analysis. Pretreating the sample with acid and heat hydrolyzes the condensed inorganic forms to orthophosphate.

Orthophosphate reacts with molybdate in an acid medium to produce a Phosphomolybdate complex. Ascorbic acid then reduces the complex, giving an intense molybdenum blue color.

Safety

Good safety habits and laboratory techniques should be used throughout the procedure. Consult the *Material Safety Data Sheet* for information specific to the reagents used. For additional information, refer to *Section 1*.

Pollution Prevention and Waste Management

Final samples will contain molybdenum. In addition, final samples will have a pH less than 2 and are considered corrosive (D002) by the Federal RCRA. Please see *Section 1* for more information on proper disposal of these materials.

PHOSPHORUS, Acid Hydrolyzable, continued

REQUIRED REAGENTS AND STANDARDS

Description	Quantity Required Per Test	Unit	Cat. No
Total and Acid Hydrolyzable Phosphorus Reagent Set.....		50 tests.....	27427-45
Includes:			
PhosVer 3 Phosphate Reagent Powder Pillows	1 pillow	50/pkg	21060-46
Potassium Persulfate Powder Pillows	1	50/pkg	20847-66
Sodium Hydroxide Standard Solution, 1.00 N.....	2 mL	100 mL	1045-42
Total and Acid Hydrolyzable Test Vials.....	1 vial	50/pkg	*

REQUIRED EQUIPMENT AND SUPPLIES

COD Reactor, 115/230 VAC, North American plug	1	each.....	45600-00
COD Reactor, 115/230 VAC, European plug	1	each.....	45600-02
DR/4000 Test Tube Adapter.....	1	each.....	48189-00
Funnel, micro	1	each.....	25843-35
Pipet, volumetric, Class A, 2.00-mL.....	1	each.....	14515-36
Pipet, volumetric, Class A, 5.00-mL.....	1	each.....	14515-37
Pipet Filler, safety bulb.....	1	each.....	14651-00
Pipet, TenSette, 1 to 10 mL	1	each.....	19700-10
Pipet Tips, for 19700-10 TenSette Pipet	1	1000/pkg.....	21997-28
Safety Shield, laboratory bench	1	each.....	23810-00
Test Tube Rack	1-3	each.....	18641-00

OPTIONAL REAGENTS AND STANDARDS

Bromine Water, 30-g/L.....		29 mL.....	2211-20
Hydrochloric Acid Standard Solution, 6.0 N (1:1)		500 mL.....	884-49
Phosphate Standard Solution, 1-mg/L as PO_4^{3-}		500 mL.....	2569-49
Phosphate Standard Solution, 50-mg/L.....		500 mL.....	171-49
Phosphate Standard Solution, 2-mL PourRite Ampule, 50-mg/L as PO_4		20/pkg.....	171-20H
Sodium Hydroxide Standard Solution, 5.0 N.....		1 L.....	2450-53
Water, deionized		4 liters.....	272-56

OPTIONAL EQUIPMENT AND SUPPLIES

pH Paper, pH 1.0 to 11.0		5 rolls/pkg.....	391-33
pH Meter, <i>sensio</i> TM <i>I</i> , portable		each.....	51700-00
Pipet, volumetric, Class A, 2.00-mL.....		each.....	14515-36
Pipet, volumetric, Class A, 4.00-mL.....		each.....	14515-04
Pipet, volumetric, Class A, 6.00-mL.....		each.....	14515-06
Pipet, volumetric, Class A, 8.00-mL.....		each.....	14515-08
Pipet, volumetric, Class A, 10.00-mL.....		each.....	14515-38
PourRite TM Ampule Breaker		each.....	24846-00
Pipet, TenSette, 0.1 to 1 mL.....		each.....	19700-01
Pipet Tips, for 19700-01 TenSette Pipet		50/pkg.....	21856-96

* Not sold separately.



FOR TECHNICAL ASSISTANCE, PRICE INFORMATION AND ORDERING:
In the U.S.A. – Call toll-free 800-227-4224
Outside the U.S.A. – Contact the HACH office or distributor serving you.
On the Worldwide Web – www.hach.com; E-mail – techhelp@hach.com

HACH COMPANY
WORLD HEADQUARTERS
Telephone: (970) 669-3050
FAX: (970) 669-2932