

## USEPA<sup>1</sup> Reactor Digestion Method<sup>2</sup>

Method 8000

0.7 to 40.0<sup>3</sup> mg/L COD (ULR); 3 to 150 mg/L COD (LR); 20 to 1500 mg/L COD (HR); 200 to 15,000 mg/L COD (HR Plus)

**Scope and application:** For water and wastewater. Digestion is required.

<sup>1</sup> Ranges 3 to 150 mg/L COD and 20 to 1500 mg/L COD are USEPA approved for wastewater analyses (Standard Method 5220 D), Federal Register, April 21, 1980, 45(78), 26811-26812.

<sup>2</sup> Jirka, A.M.; Carter, M.J., Analytical Chemistry, 1975, 47(8), 1397.

<sup>3</sup> The ULR is only available with spectrophotometers that can measure at a wavelength of 350 nm.



## Test preparation

### Instrument-specific information

Table 1 shows all of the instruments that have the program for this test. The table also shows the adapter and light shield requirements for the instruments that use them.

To use the table, select an instrument, then read across to find the applicable information for this test.

**Table 1 Instrument-specific information for test tubes**

Instrument	Adapters	Light shield
DR6000, DR5000	—	—
DR3900	—	LZV849
DR3800, DR2800, DR2700	—	LZV646
DR1900	9609900 (D <sup>1</sup> )	—
DR900	4846400	Cover supplied with the instrument

### Before starting

Install the instrument cap on the DR900 cell holder before ZERO or READ is pushed.

DR3900, DR3800, DR2800 and DR2700: Install the light shield in Cell Compartment #2 before this test is started.

The reagent that is used in this test is corrosive and toxic. Use protection for eyes and skin and be prepared to flush any spills with running water.

The reagents that are used in this test contain mercury. Collect the reacted samples for safe disposal.

Review the Safety Data Sheets (MSDS/SDS) for the chemicals that are used. Use the recommended personal protective equipment.

Run one blank with each set of samples. Run all tests (the samples and the blank) with the same lot of vials. The lot number is on the container label. Refer to [Blanks for colorimetric determination](#) on page 4.

Store unused (light sensitive) vials in a closed box.

If the samples contain high concentrations of chloride, refer to the Alternate reagents section.

Dispose of reacted solutions according to local, state and federal regulations. Refer to the Safety Data Sheets for disposal information for unused reagents. Refer to the environmental, health and safety staff for your facility and/or local regulatory agencies for further disposal information.

<sup>1</sup> The D adapter is not available with all instrument versions.

## Items to collect

Description	Quantity
Beaker, 250-mL	1
Blender	1
COD Digestion Reagent vials	varies
DRB200 Reactor	1
Light shield or adapter (For information about sample cells, adapters or light shields, refer to <a href="#">Instrument-specific information</a> on page 1.)	1
Magnetic stirrer and stir bar	1
Opaque shipping container for storage of unused, light-sensitive reagent vials	varies
Pipet, TenSette, 0.1- to 1.0-mL, with pipet tips (for use with the 200–15,000 mg/L range)	1
Pipet, volumetric, 2.00-mL	2
Pipet filler safety bulb	1
Test tube rack	2

Refer to [Consumables and replacement items](#) on page 7 for order information.

## Sample collection and storage

- Collect samples in clean glass bottles. Use plastic bottles only if they are known to be free of organic contamination.
- Test biologically active samples as soon as possible.
- Homogenize samples that contain solids to get a representative sample.
- To preserve samples for later analysis, adjust the sample pH to less than 2 with concentrated sulfuric acid (approximately 2 mL per liter). No acid addition is necessary if the sample is tested immediately.
- Keep the preserved samples at 2–6 °C (36–43 °F) for a maximum of 28 days.
- Correct the test result for the dilution caused by the volume additions.

## Reactor digestion procedure

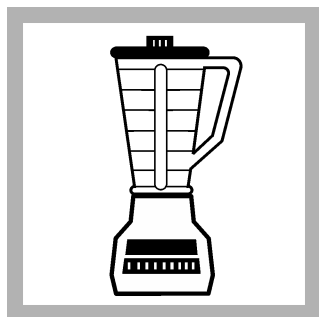

1. Put 100 mL of sample in a blender. Blend for 30 seconds or until homogenized.

For samples with large amounts of solids, increase the homogenization time. If the sample does not contain suspended solids, go to step 3.

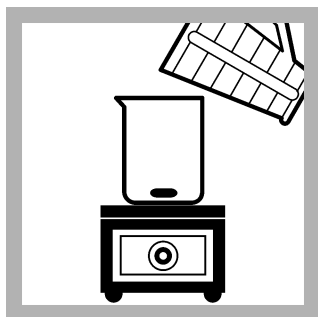

2. For the 200–15,000 mg/L range or to improve accuracy and reproducibility of the other ranges, pour the homogenized sample into a 250-mL beaker and gently stir with a magnetic stir plate.

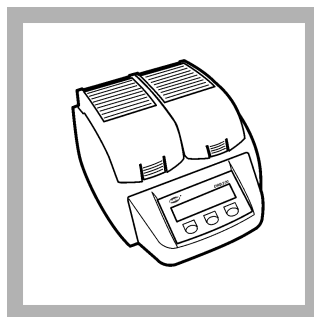

3. Set the DRB200 Reactor power to on. Preheat to 150 °C.

Refer to the DRB200 User Manual for selecting pre-programmed temperature applications.



**4. Prepare the sample:** Remove the cap from a vial for the selected range. Hold the vial at an angle of 45 degrees. Use a clean pipet to add 2.00 mL of sample to the vial.

For 250–15,000 mg/L vials: Use a TenSette Pipet to add 0.20 mL of sample to the vial.



**5. Prepare the blank:**  
Remove the cap from a second vial for the selected range. Hold the vial at an angle of 45 degrees. Use a clean pipet to add 2.00 mL of deionized water to the vial.

For 250–15,000 mg/L vials:  
Use a TenSette Pipet to add 0.20 mL of deionized water to the vial.

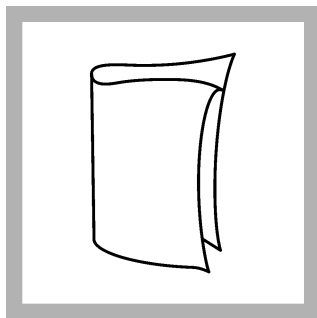

**6.** Close the vials tightly. Rinse the vials with water and wipe with a clean paper towel.

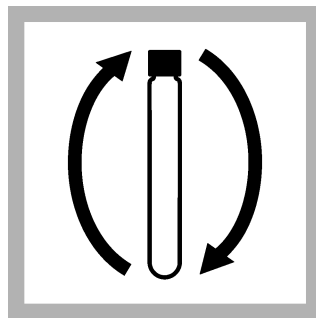

**7.** Hold the vials by the cap, over a sink. Invert gently several times to mix. **The vials get very hot during mixing.**

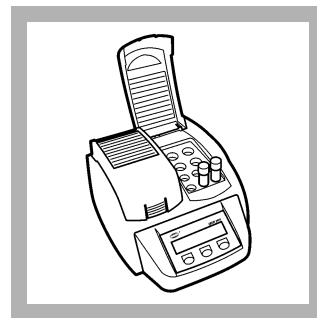

**8.** Put the vials in the preheated DRB200 reactor. Close the lid.

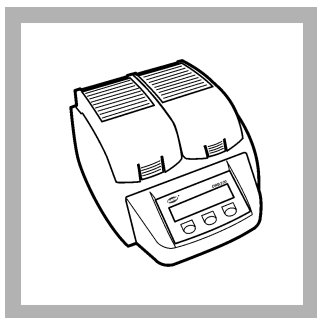

**9.** Heat the vials for 2 hours.

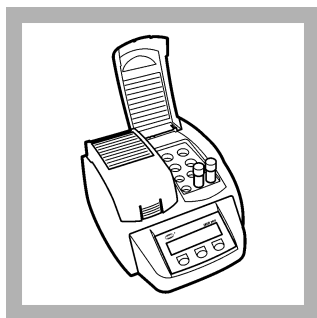

**10.** Set the reactor power to off. Let the vials cool in the reactor for approximately 20 minutes to 120 °C or less.

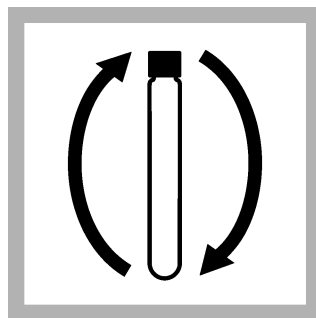

**11.** Invert each vial several times while it is still warm.

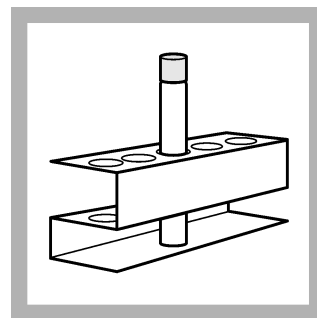

**12.** Put the vials in a tube rack to cool to room temperature.

## Colorimetric procedure

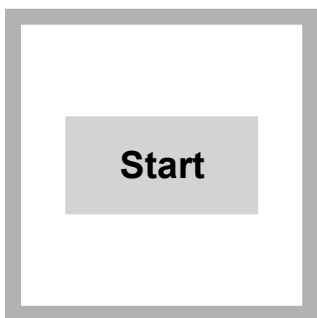

**1.** Start program **431 COD ULR**, **430 COD LR** or **435 COD HR**. For information about sample cells, adapters or light shields, refer to [Instrument-specific information](#) on page 1.

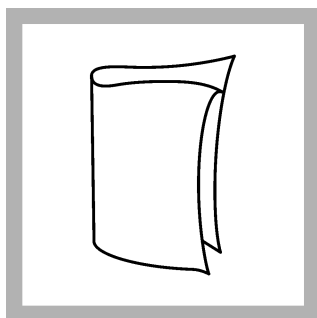

**2.** Clean the blank sample cell.

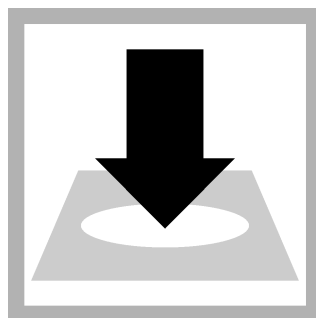

**3.** Insert the blank into the cell holder.

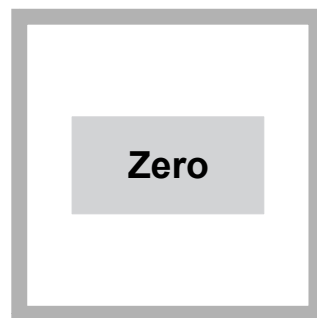

**4.** Push **ZERO**. The display shows 0 or 0.0 mg/L COD.

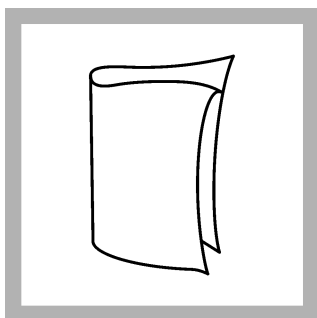

5. Clean the prepared sample cell.

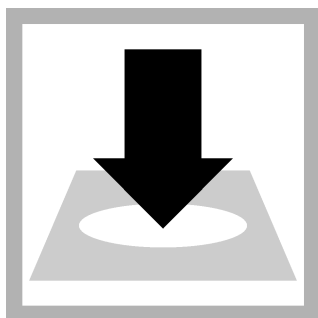

6. Insert the prepared sample into the cell holder.



7. Push **READ**. Results show in mg/L COD.

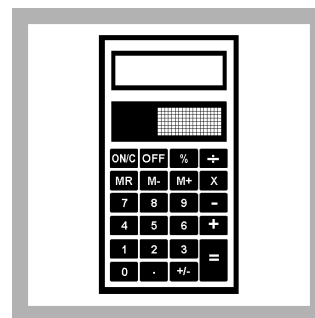

8. If using High Range Plus COD digestion reagent vials, multiply the result by 10. For the most accurate results with samples near 1500 or 15,000 mg/L COD, repeat the analysis with a diluted sample.

## Blanks for colorimetric determination

The blank vial can be used again and again for measurements that use the same lot of reagent vials. Measure the absorbance of the blank vial over time and prepare a new blank vial when the absorbance changes.

1. Put the instrument in the absorbance mode at the applicable wavelength. Refer to [Table 3](#) on page 6.
2. Add 5 mL of deionized water into an empty vial.
3. Put the vial in the instrument and zero the instrument.
4. Put the blank vial that is used in the test procedure into the instrument and record the absorbance value.
5. Keep the blank vial in the dark.
6. Prepare a new blank when the absorbance has changed by approximately 0.01 absorbance units.

## Interferences

Chloride is the primary interference in this test procedure. Each COD vial contains mercuric sulfate that removes chloride interference to the level specified in Column 1 of [Table 2](#). Dilute samples that have higher chloride concentrations to the level given in Column 2.

**Note:** For best results, use the low range and ultra-low range vials for samples that have high chloride concentrations (near maximum concentration) and low COD concentrations.

If sample dilution causes the COD concentration to be too low for accurate measurements, add 0.50 g of mercuric sulfate ( $\text{HgSO}_4$ ) to each COD vial before the sample is added. The additional mercuric sulfate will increase the maximum chloride concentration to the level given in Column 3.

**Note:** Bromide interference is not removed with mercuric sulfate.

**Table 2 Chloride concentration limits in the sample**

Vial range	Column 1 (maximum mg/L $\text{Cl}^-$ )	Column 2 (mg/L $\text{Cl}^-$ for diluted samples)	Column 3 (maximum mg/L $\text{Cl}^-$ with mercuric sulfate)
ULR <sup>2</sup> (0.7–40.0 mg/L)	2000	1000	N/A
LR (3–150 mg/L)	2000	1000	8000

<sup>2</sup> The ULR is only available for spectrophotometers that can measure at a wavelength of 350 nm.

**Table 2 Chloride concentration limits in the sample (continued)**

Vial range	Column 1 (maximum mg/L Cl <sup>-</sup> )	Column 2 (mg/L Cl <sup>-</sup> for diluted samples)	Column 3 (maximum mg/L Cl <sup>-</sup> with mercuric sulfate)
HR (20–1500 mg/L)	2000	1000	4000
HR Plus (200–15,000 mg/L)	20,000	10,000	40,000

## Accuracy check

### Standard solution method

Items to collect:

- 1000 mg/L COD standard solution
- 100-mL volumetric flask, Class A
- Volumetric pipets, Class A and pipet filler
- Deionized water
- Potassium acid phthalate (KHP), dried overnight at 120 °C (HR Plus only)

#### 0.7 to 40.0 mg/L ULR

1. Prepare a 30-mg/L COD standard solution as follows:
  - a. Use a pipet to add 3.00 mL of the 1000 mg/L standard solution into a 100-mL volumetric flask.
  - b. Dilute to the mark with deionized water. Mix well.
2. Use the test procedure to measure the concentration of the standard solution.
3. Compare the expected result to the actual result.  
*Note: The factory calibration can be adjusted slightly with the standard calibration adjust option so that the instrument shows the expected value of the standard solution. The adjusted calibration is then used for all test results. This adjustment can increase the test accuracy when there are small variations in the reagents or instruments.*

#### 3 to 150 mg/L LR

1. Prepare a 100-mg/L COD standard solution as follows:
  - a. Use a pipet to add 10 mL of the 1000 mg/L standard solution into a 100-mL volumetric flask.
  - b. Dilute to the mark with deionized water. Mix well.
2. Use the test procedure to measure the concentration of the standard solution.
3. Compare the expected result to the actual result.  
*Note: The factory calibration can be adjusted slightly with the standard calibration adjust option so that the instrument shows the expected value of the standard solution. The adjusted calibration is then used for all test results. This adjustment can increase the test accuracy when there are small variations in the reagents or instruments.*

#### 20 to 1500 mg/L HR

1. Use the test procedure with a 300-mg/L, 800 mg/L or 1000 mg/L COD standard solution to measure the concentration of the standard solution.
2. Compare the expected result to the actual result.  
*Note: The factory calibration can be adjusted slightly with the standard calibration adjust option so that the instrument shows the expected value of the standard solution. The adjusted calibration is then used for all test results. This adjustment can increase the test accuracy when there are small variations in the reagents or instruments.*

## 200 to 15,000 mg/L HR Plus

1. Prepare a 10,000 mg/L COD standard solution as follows:
  - a. Dissolve 8.500 g of dried KHP in 1000-mL of organic-free deionized water.
2. Use the test procedure to measure the concentration of the standard solution.
3. Compare the expected result to the actual result.

**Note:** The factory calibration can be adjusted slightly with the standard calibration adjust option so that the instrument shows the expected value of the standard solution. The adjusted calibration is then used for all test results. This adjustment can increase the test accuracy when there are small variations in the reagents or instruments.

## Alternate reagents

Mercury-free COD2 Reagents are available as a mercury-free alternative. These reagents are fully compatible with test procedures and stored programs in the instruments. Chloride and ammonia determinations are recommended for accurate results.

## NOTICE

COD2 reagents are not approved for USEPA reporting purposes. Because COD2 reagents do not contain mercury as a masking agent, they exhibit a positive interference from chloride. More information is available for use with specific applications.

## Method performance

The method performance data that follows was derived from laboratory tests that were measured on a spectrophotometer during ideal test conditions. Users can get different results under different test conditions.

Program	Standard	Precision (95% Confidence Interval)	Sensitivity Concentration change per 0.010 Abs change
431 (ULR)	30 mg/L COD	28.8–31.2 mg/L COD	0.5 mg/L COD
430 (LR)	80 mg/L COD	77–83 mg/L COD	3 mg/L COD
435 (HR)	800 mg/L COD	785–815 mg/L COD	23 mg/L COD
435 (HR Plus)	8000 mg/L COD	7850–8150 mg/L COD	230 mg/L COD

## Summary of method

The results in mg/L COD are defined as the milligrams of O<sub>2</sub> consumed per liter of sample under the conditions of this procedure. The sample is heated for 2 hours with sulfuric acid and a strong oxidizing agent, potassium dichromate. Oxidizable organic compounds react, reducing the dichromate ion (Cr<sub>2</sub>O<sub>7</sub><sup>2-</sup>) to green chromic ion (Cr<sup>3+</sup>). When the 0.7–40.0 or the 3–150 mg/L colorimetric method is used, the amount of Cr<sup>6+</sup> that remains is measured. When the 20–1500 mg/L or 200–15,000 mg/L colorimetric method is used, the amount of Cr<sup>3+</sup> that is produced is measured. The COD reagent also contains silver and mercury ions. Silver is a catalyst, and mercury is used to complex chloride interferences.

Test results are measured at the wavelengths that are specified in [Table 3](#).

**Table 3 Range-specific test wavelengths**

Range in mg/L COD	Wavelength
0.7–40.0 mg/L	350 nm (for applicable instruments)
3–150 mg/L	420 nm
20–1500	620 nm (610 nm for colorimeters)
200–15,000 mg/L	620 nm (610 nm for colorimeters)

## Pollution prevention and waste management

Reacted samples contain mercury, silver and chromium and must be disposed of as a hazardous waste. Dispose of reacted solutions according to local, state and federal regulations. Users in the United States can use the ez COD Recycling Service for disposal of COD vials. Refer to [Consumables and replacement items](#) on page 7.

## Consumables and replacement items

### Required reagents

Description	Quantity/test	Unit	Item no.
COD, Ultra Low Range, 0.7–40 mg/L	1–2 vials	25/pkg	2415825
COD, Low Range, 3–150 mg/L	1–2 vials	25/pkg	2125825
COD, High Range, 20–1500 mg/L	1–2 vials	25/pkg	2125925
COD, High Range Plus, 200–15,000 mg/L	1–2 vials	25/pkg	2415925
Water, deionized	varies	4 L	27256

### Alternate reagents and package sizes

Description	Quantity/test	Unit	Item no.
COD2, Low Range, 0–150 mg/L COD	1–2 vials	25/pkg	2565025
COD2, High Range, 0–1500 mg/L COD	1–2 vials	25/pkg	2565125
COD2, High Range, 0–1500 mg/L COD	1–2 vials	150/pkg	2565115
COD2, High Range Plus, 0–15,000 mg/L COD	1–2 vials	25/pkg	2834325
COD Digestion Reagent Vials, 3–150 mg/L COD	1–2 vials	150/pkg	2125815
COD Digestion Reagent Vials, 200–1500 mg/L COD	1–2 vials	150/pkg	2125915
COD Digestion Reagent Vials, ULR 0.7–40.0 mg/L	1–2 vials	150/pkg	2415815
COD Digestion Reagent Vials, HR plus, 200–15,000 mg/L	1–2 vials	150/pkg	2415915

### Required apparatus

Description	Quantity/test	Unit	Item no.
Blender, 2-speed, 120 VAC option	1	each	2616100
OR			
Blender, 2-speed, 240 VAC option	1	each	2616102
DRB200 Reactor, 110 VAC option, 15 x 16-mm wells	1	each	LTV082.53.40001
OR			
DRB200 Reactor, 220 VAC option, 15 x 16-mm wells	1	each	LTV082.52.40001
Pipet filler, safety bulb	1	each	1465100
Pipet, volumetric, Class A, 2.00 mL	1	each	1451536

### Recommended standards and apparatus

Description	Unit	Item no.
Beaker, 250 mL	each	50046H
COD Standard Solution, 300 mg/L	200 mL	1218629
COD Standard Solution, 300 mg/L	500mL	1218649

**Recommended standards and apparatus (continued)**

Description	Unit	Item no.
COD Standard Solution, 800 mg/L	200 mL	2672629
COD Standard Solution, 1000 mg/L	200 mL	2253929
Oxygen Demand Standard (BOD, COD, TOC), 10-mL ampules	16/pkg	2833510
Pipet, TenSette <sup>®</sup> , 0.1–1.0 mL	each	1970001
Pipet tips for TenSette <sup>®</sup> Pipet, 0.1–1.0 mL	50/pkg	2185696
Pipet tips for TenSette <sup>®</sup> Pipet, 0.1–1.0 mL	1000/pkg	2185628
Potassium Acid Phthalate (KHP), ACS	500 g	31534
Stir bar, octagonal	each	2095352
Stirrer, electromagnetic, 120 VAC, with electrode stand	each	4530001
Stirrer, electromagnetic, 230 VAC, with electrode stand	each	4530002
Test tube rack, stainless steel	each	1864100
Wipes, disposable	70/pkg	2096900

**Optional reagents and apparatus**

Description	Unit	Item no.
Balance, analytical, 80 g x 0.1 mg 100–240 VAC	each	2936701
Flask, volumetric, Class A, 1000 mL glass	each	1457453
Flask, volumetric, Class A, 100 mL, glass	each	1457442
Pipet, volumetric, Class A, 3 mL	each	1451503
Pipet, volumetric, Class A, 10 mL	each	1451538
Sulfuric Acid, ACS	500 mL	97949
Wastewater Influent Standard Solution, Mixed Parameter, for NH <sub>3</sub> -N, NO <sub>3</sub> -N, PO <sub>4</sub> <sup>3-</sup> , COD, SO <sub>4</sub> <sup>2-</sup> , TOC	500 mL	2833149
EZ COD™ Recycling Service with 5-gal bucket-mail back option (For US customers only. 20 and 55 gallon sizes are also available. )	each	2895405
EZ COD™ Recycling Service with 5-gal bucket- pick up option. (For US customers only. 20 and 55 gallon sizes are also available. )	each	2895405P
Finger cots	2/pkg	1464702
Gloves, chemical resistant, size 9–9.5	pair	2410104 <sup>3</sup>
Paper, for weighing, 100 x 100 mm	500/pkg	1473885
Safety goggles, vented	each	2550700
Wastewater Effluent Standard Solution, Mixed Parameter, for NH <sub>3</sub> -N, NO <sub>3</sub> -N, PO <sub>4</sub> <sup>3-</sup> , COD, SO <sub>4</sub> <sup>2-</sup> , TOC	500 mL	2833249

<sup>3</sup> Other sizes available



**FOR TECHNICAL ASSISTANCE, PRICE INFORMATION AND ORDERING:**  
 In the U.S.A. – Call toll-free 800-227-4224  
 Outside the U.S.A. – Contact the HACH office or distributor serving you.  
 On the Worldwide Web – [www.hach.com](http://www.hach.com); E-mail – [techhelp@hach.com](mailto:techhelp@hach.com)

**HACH COMPANY**  
 WORLD HEADQUARTERS  
 Telephone: (970) 669-3050  
 FAX: (970) 669-2932