

Scope and Application: For water and wastewater

* Patent pending



1. Turn on the COD reactor. Heat to 103-105 °C. Place the plastic shield in front of the reactor.

Note: Ensure safety devices are in place to protect the analyst should leakage occur.



2. Use a graduated cylinder to add 10 mL of sample to a 50-mL erlenmeyer flask containing a stir bar.



3. Add 0.4 mL of Buffer Solution, pH 2.0.

Note: Use pH paper to make sure the sample pH is 2.

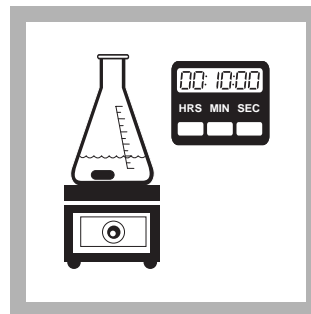

4. Place the flask on a stir plate and stir at a moderate speed for 10 minutes.

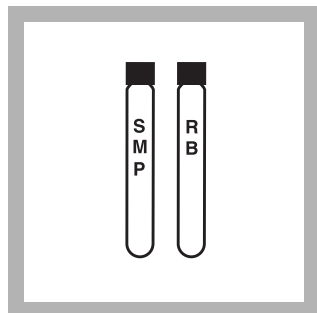

5. Label two Low Range Acid Digestion vials: **sample** and **reagent blank**.

Note: A reagent blank is required for each series of samples.

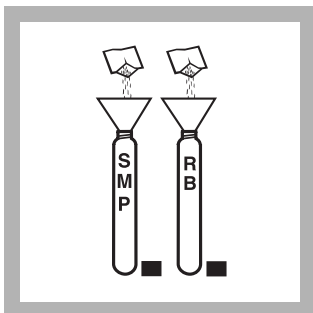

6. Using a funnel, add the contents of one TOC Persulfate Powder Pillow to each Acid Digestion vial (colorless liquid).

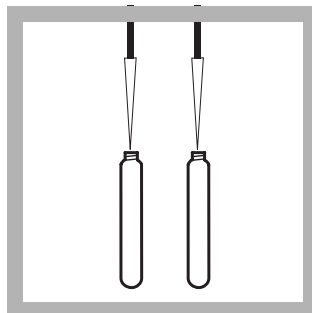

7. Use a TenSette Pipet to add 3.0 mL of **organic-free water** to the **reagent blank** vial and 3.0 mL of **prepared sample** to the **sample** vial. Do not cap; swirl gently to mix.

Note: The organic-free water must contain less than 0.05 mg/L carbon. See Reagent Blanks.



8. Rinse two blue Indicator Ampules with deionized water and wipe them with a soft, lint-free wipe.

Note: Do not touch the ampules on the sides after wiping. Pick them up by the top.

ORGANIC CARBON, Total, continued

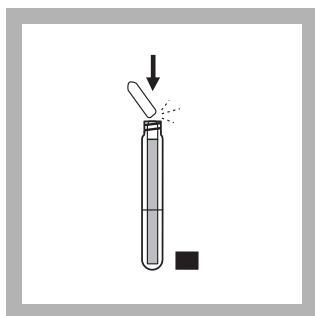

9. Lower one unopened ampule into each Acid Digestion vial. When the score mark on the ampule is level with the top of the Acid Digestion vial, snap the top off the ampule and allow it to drop into the Acid Digestion vial.

Note: Do not invert or tilt the vial after inserting the ampule to prevent the Indicator Reagent from mixing with the contents of the acid digestion vial.

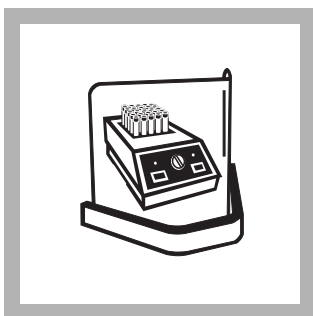

10. Cap the vial assemblies tightly and place them in the COD reactor for 2 hours at 103-105 °C.

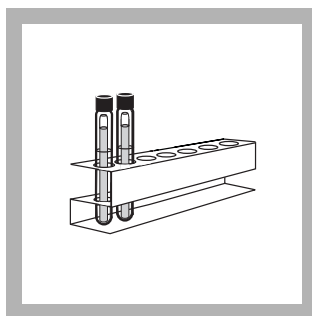

11. Carefully remove the vial assemblies from the reactor. Place them in a test tube rack.

Allow the vials to cool for **one hour** for accurate results.



12. Insert the Test 'N Tube™ adapter into the sample cell module by sliding it under the thumb screw and into the alignment grooves. Fasten with the thumb screw.

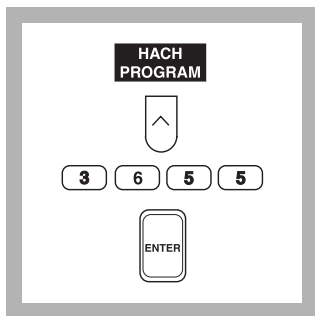

13. Press the soft key under **HACH PROGRAM**.

Select the stored program number for the Low Range TOC method by pressing **3655** with the numeric keys.

Press: **ENTER**



14. The display will show:
HACH PROGRAM: 3655 TOC, LR

The instrument automatically selects the multi-wavelength setting at 598 and 430 nm.

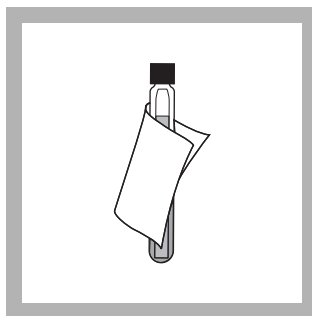

15. Wipe the reagent blank with a damp towel, followed by a dry one, to remove fingerprints or other marks.

Note: The liquid in the reagent blank vial should be dark blue.



16. Place the **reagent blank** vial assembly in the adapter. Close the light shield.

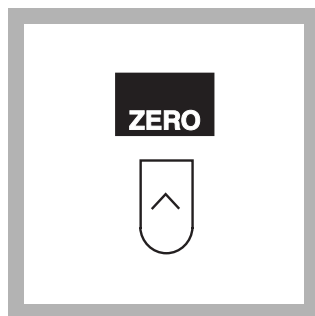

17. Press the soft key under **ZERO**.

The display will show:

0.0 mg/L C

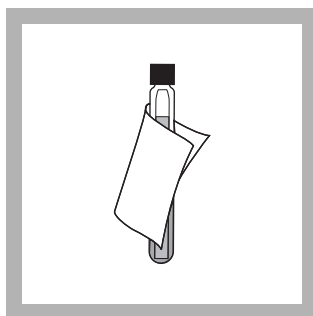

18. Wipe the sample vial assembly with a damp towel, followed by a dry one, to remove fingerprints or other marks.

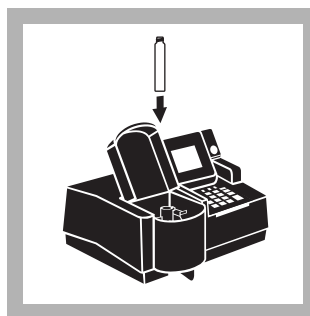

19. Place the sample vial assembly in the adapter. Close the light shield. The result in mg/L C will be displayed.

Sampling and Storage

Collect samples in clean glass bottles. Rinse the sample bottle several times with the sample to be collected. Fill the bottle with minimum headspace before capping. Test samples as soon as possible. Acid preservation is not recommended. Homogenize samples containing solids to assure representative samples.

Reagent Blanks

Water used for the reagent blank must contain less than 0.05 mg/L carbon. If the organic-free water container is left open for extended periods, the water may absorb carbon dioxide (CO₂) from the atmosphere. To remove the dissolved CO₂ from the organic-free water, it is necessary to acid-sparge it (see steps 2–4 of the procedure).

Generally, water stored in plastic containers is not suitable for low-range TOC blanks. Water stored in plastic may leach organic compounds from the container walls. The leached organic compounds usually cannot be removed by acid sparging.

Accuracy Check

Standard Solutions Method

- a. Prepare a 1000 mg/L organic carbon stock standard by dissolving 2.1254 g dry primary standard Potassium Acid Phthalate in Organic-Free Reagent Water and dilute to 1000 mL. This stock standard is stable for about 1 month at room temperature.

Alternatively, open one ampule of TOC Standard Solution (Cat. No. 27915-05).

- b. Prepare a 10.0 mg/L C standard by transferring 10.00 mL of the stock standard to a 1000-mL Class A volumetric flask. Dilute to volume using Organic-Free Reagent Water. Stopper and mix thoroughly. Prepare this standard fresh daily.

ORGANIC CARBON, Total, continued

Standard Additions Method

- a. Prepare a 150 mg/L C standard by transferring 15.00 mL of 1000 mg/L C stock solution to a 100-mL Class A volumetric flask. Dilute to volume with organic-free water. Mix.
- b. Use the TenSette Pipet to add 0.1, 0.2, and 0.3 mL of the 150 mg/L C standard to each of three Acid Digestion vials.
- c. Add the contents of one TOC Persulfate powder pillow to each vial.
- d. Add 3.0 mL of sample to each vial. Swirl to mix.
- e. Proceed with the procedure starting at *step 8*.
- f. The mg/L C concentration should increase by 5.0 mg/L for each 0.1 mL increment.

Method Performance

Precision

at mg/L C	95% Confidence Limits
1	±1.3 mg/L
5	±1.0 mg/L
10	±0.8 mg/L
15	±0.7 mg/L
20	±0.7 mg/L

Estimated Detection Limit

Program	EDL
3655	0.3 mg/L C

For more information on derivation and use of Hach's estimated detection limit, see *Estimated Detection Limit*. To determine a method detection limit (MDL) as defined by the 40 CFR part 136, Appendix B, see *Determining the Method Detection Limit (MDL)*.

Sensitivity

Program Number: 3655

Portion of Curve	Δ Abs	Δ Concentration
at 5.0 mg/L C	0.010	0.19 mg/L C
at 10.0 mg/L C	0.010	0.16 mg/L C
at 15.0 mg/L C	0.010	0.14 mg/L C

See *Sensitivity Explained* for more information.

Interferences

The following have been tested for interference and found not to interfere up to the indicated levels:

Table 1 Non-interfering Substances (Maximum Level Tested)

Substance	Maximum Level Tested
Aluminum	10 mg/L
Ammonia Nitrogen	1000 mg/L as N
ASTM Wastewater	No effect
Bromide	500 mg/L Br
Bromine	25 mg/L Br ₂
Calcium	2000 mg/L as CaCO ₃
Chloride	500 mg/L
Chlorine	10 mg/L Cl ₂
Chlorine Dioxide	6 mg/L ClO ₂
Copper	10 mg/L
Cyanide	10 mg/L CN
Iodide	50 mg/L
Iron (II)	10 mg/L
Iron (III)	10 mg/L
Magnesium	2000 mg/L as CaCO ₃
Manganese (VII)	1 mg/L
Monochloramine	14 mg/L NH ₂ Cl as Cl ₂
Nitrite	500 mg/L NO ₂ ⁻
Ozone	2 mg/L O ₃
Phosphate	3390 mg/L PO ₄ ²⁻
Silica	100 mg/L SiO ₂
Sulfate	5000 mg/L SO ₄ ²⁻
Sulfide	20 mg/L S ²⁻
Sulfite	50 mg/L SO ₃ ²⁻
Zinc	5 mg/L

If the sample contains greater than 600 mg/L CaCO₃ alkalinity, lower the sample pH to less than 7 before testing by adding sulfuric acid solution.

Most sample turbidity is either dissolved during the digestion stage or settled during the cooling period. Sample turbidities up to 50 NTU have been tested without interference.

Summary of Method

The total organic carbon (TOC) is determined by first sparging the sample under slightly acidic conditions to remove the inorganic carbon. In the outside vial, organic carbon in the sample is digested by persulfate and acid to form carbon dioxide. During digestion, the carbon dioxide diffuses into a pH indicator reagent in the inner ampule. The adsorption of carbon dioxide into the indicator forms carbonic acid. Carbonic acid changes the pH of the indicator solution which, in turn, changes the color. The amount of color change is related to the original amount of carbon present in the sample.

ORGANIC CARBON, Total, continued

REQUIRED REAGENTS

Total Organic Carbon Direct Method Low Range

Test 'N Tube Reagent Set.....50 vials.....27603-45

Includes:

Description	Quantity Required		Cat. No.
	Per Test	Unit	
Acid Digestion Solution Vials, Low Range TOC	1	50/pkg	*
Buffer Solution, Sulfate.....	0.4 mL.....	25 mL.....	452-33
Funnel, micro	1	each.....	25843-35
Indicator Ampules, Low Range TOC.....	1	10/pkg.....	*
TOC Persulfate Powder Pillows	1	50/pkg.....	*
Water, Organic-free**	3.0 mL.....	500 mL.....	26415-49

REQUIRED APPARATUS

COD Reactor, 115/230 V ac (U.S.A. and Canada)	1	each.....	45600-00
COD Reactor, 115/230 V ac (Europe)	1	each.....	45600-02
Cylinder, graduated, 10-mL	1	each.....	508-38
Flask, Erlenmeyer, 50-mL.....	1	each.....	505-41
Magnetic Stirrer.....	1	each.....	23436-00
Safety Shield, laboratory bench	1	each.....	50030-00
Test Tube Rack	1-3.....	each.....	18641-00
Pipet, TenSette®, 0.1 to 1.0 mL.....	1	each.....	19700-01
Pipet, TenSette®, 1.0 to 10.0 mL.....	1	each.....	19700-10
Pipet Tips, for 19700-01 TenSette® Pipet	2	50/pkg.....	21856-96
Pipet Tips, for 19700-10 TenSette® Pipet	2	50/pkg.....	25589-96
Stir Bar, Magnetic	1	each.....	45315-00
Wipes, Disposable, Kimwipes.....	1	280/pkg.....	20970-00

OPTIONAL REAGENTS

TOC Standard Solution (KHP Standard, 1000 mg/L C).....	5/pkg.....	27915-05
Potassium Acid Phthalate.....	500 g.....	315-34
Sulfuric Acid Reagent Solution, 5.25 N.....	100 mL MDB.....	2449-32

OPTIONAL APPARATUS

Analytical Balance	each.....	26103-00
Flask, volumetric, 1000-mL.....	each.....	14574-53
Flask, volumetric, 100-mL.....	each.....	14574-42
Pipet, Class A, 10.00-mL	each.....	14515-38
Pipet, Class A, 15.00-mL	each.....	14515-39

* These items are not sold separately.

** This item must be purchased separately.



FOR TECHNICAL ASSISTANCE, PRICE INFORMATION AND ORDERING:
In the U.S.A. – Call toll-free 800-227-4224
Outside the U.S.A. – Contact the HACH office or distributor serving you.
On the Worldwide Web – www.hach.com; E-mail – techhelp@hach.com

HACH COMPANY
WORLD HEADQUARTERS
Telephone: (970) 669-3050
FAX: (970) 669-2932