

Immunoassay¹

Method 10050

Scope and application: For water.

¹ This test is semi-quantitative. Results are shown as more or less than the threshold value used.



Test preparation

Instrument specific information

[Table 1](#) shows all of the instruments that can be used for this test. The table also shows adapter requirements for the instruments that use them.

To use the table, select an instrument, then read across to find the corresponding information for this test.

Table 1 Instrument-specific information

Instrument	Adapter
DR 6000	—
DR 5000	A23618
DR 3900	LZV846 (A)
DR 1900	9609800 or 9609900 (A)
DR 3800, DR 2800, DR 2700	LZV583

Before starting

In this procedure, the user adds sample calibrators and reagents to cuvettes that contain Atrazine-specific antibodies. The color that develops is measured and compared with the other color measurements of the calibrators. For complete analysis, the test requires about 30 minutes. A maximum of 20 cuvettes (18 samples and 2 calibrators) can be prepared at the same time.

Before the procedure starts, read the full procedure. Identify and prepare all the necessary reagents, cuvettes and other apparatus, then start the procedure.

Timing is very important in this procedure. Follow the instructions carefully.

It is very important to use a consistent technique to mix the solution in the cuvettes. Refer to [Use of the 1-cm MicroCuvette rack](#) on page 4. If the cuvettes are individually mixed, the results can be less consistent.

Be careful with the cuvettes. A scratch on the inner or outer cuvette surfaces can cause incorrect results. Carefully clean the outer surfaces with a clean, absorbent cloth or tissue before use.

Antibody cuvettes and enzyme conjugate are made in matched lots. Do not mix reagent lots.

Keep the color developing solution out of direct sunlight to prevent deterioration.

The cuvette rack can be inverted with the cuvettes in the rack. This lets the user prepare many samples at the same time. The cuvettes stay in the rack until the results are read in the instrument.

Each reagent set has 20 antibody cuvettes. Use one antibody cuvette for each calibrator and each sample. Cuvettes are not reusable.

Use protective nitrile gloves for this procedure.

Review the Safety Data Sheets (MSDS/SDS) for the chemicals that are used. Use the recommended personal protective equipment.

Dispose of reacted solutions according to local, state and federal regulations. Refer to the Safety Data Sheets for disposal information for unused reagents. Refer to the environmental, health and safety staff for your facility and/or local regulatory agencies for further disposal information.

Items to collect

Description	Quantity
Atrazine Reagent Set	1
Caps, flip spout	1
Marker, laboratory	1
Pipet, TenSette, 0.1–1.0 mL	1
Pipet tips, for TenSette Pipet, 0.1–1.0-mL	1
Rack, for 1-cm Micro Cuvettes	1
Wipes, disposable	1

Refer to [Consumables and replacement items](#) on page 7 for order information.

Sample collection and storage

- Collect the samples in a clean glass bottle.
- **Do not rinse the bottle with the sample.**
- If the sample cannot be used immediately, keep the sample in storage at 6 °C (43 °F) for a maximum of 14 days.
- Let the sample temperature increase to room temperature before analysis.

Immunoassay procedure

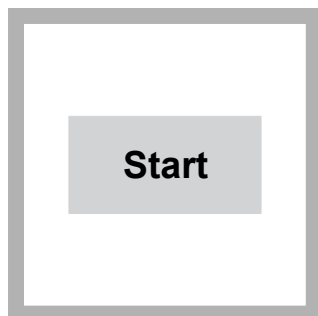

1. Push **SINGLE WAVELENGTH>OPTIONS**, then the λ key. Enter **450 nm** and push OK. For information about adapters refer to [Instrument specific information](#) on page 1. Refer to the instrument documentation for orientation.

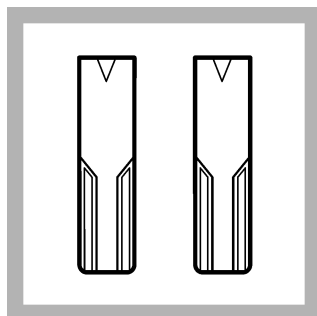

2. Put marks on the cuvettes to identify the samples and calibrators.

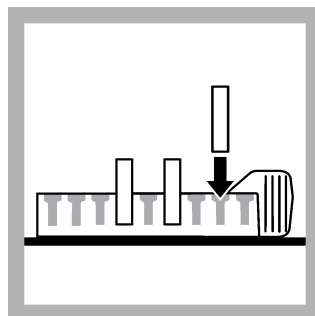

3. Insert the cuvettes into the rack. Make sure that the cuvettes are secure. Do not use force to put them into position because the cuvettes can spill or can be difficult to remove.

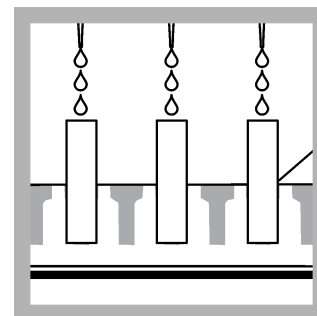

4. Use a pipet to add 0.5 mL of each **calibrator** into the applicable cuvette. Use a new pipette tip for each calibrator.

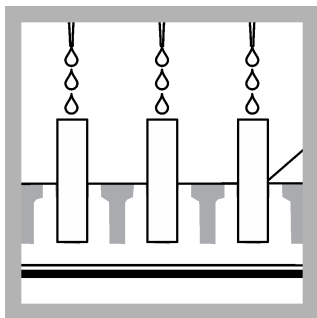

5. Use a pipet to add 0.5 mL of each **sample** into the applicable cuvette. Use a new pipette tip for each sample.

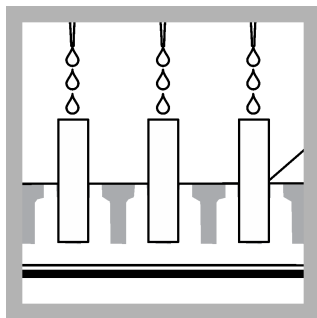

6. Immediately use a pipet to add 0.5 mL of atrazine Enzyme Conjugate into each calibrator and sample cuvette. The same pipette tip can be used for this step.



7. Start the instrument timer. The reaction time starts.

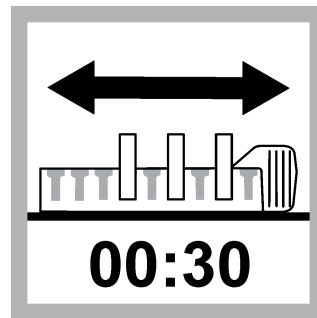

8. Immediately mix the cuvettes for 30 seconds. Refer to [Use of the 1-cm MicroCuvette rack](#) on page 4 for the correct mixing procedure.

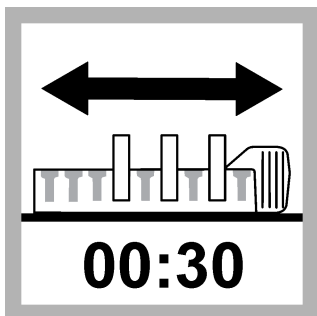

9. After 10 minutes, mix the cuvettes for 30 seconds again.

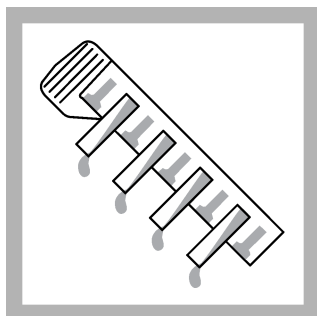

10. At the end of the 20-minute reaction period, discard the contents of all the cuvettes into a waste container for disposal.

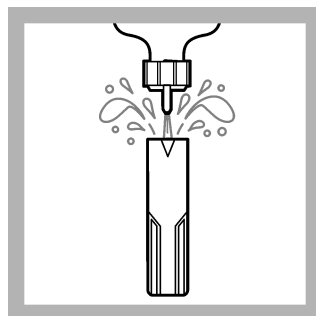

11. Fully rinse each cuvette with deionized water four times. Discard the contents into the waste container for disposal. Turn the cuvettes and rack upside down on a paper towel to dry. Carefully tap the cuvettes on the towel to remove the liquid.

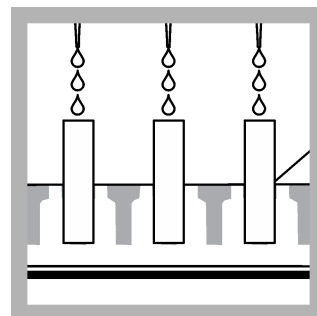

12. **Start color development:** Timing is very important. Make sure that the cuvettes are still in position in the rack. Use a pipet to add 0.5 mL of Color Developing Solution into each cuvette. The same pipette tip can be used for each cuvette.



13. Start the instrument timer. The reaction time starts.

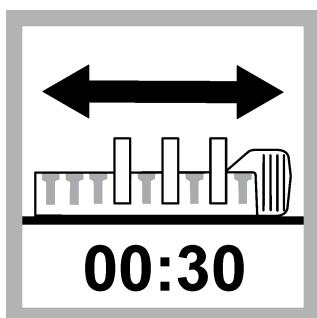

14. Immediately mix the cuvettes for 30 seconds.

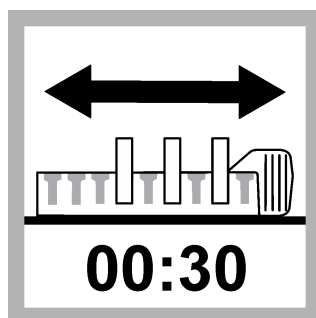

15. After 5 minutes, mix the cuvettes for 30 seconds. The solutions in some or all of the cuvettes change to blue.

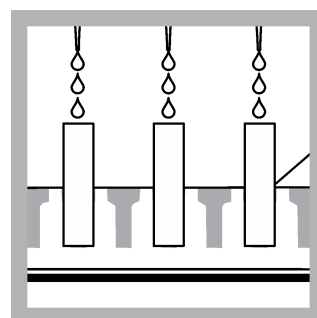

16. When the timer expires, use a pipette to add 0.5 mL of Stop Solution into each cuvette with the same pipette tip. Consistent technique is very important. Add the solution in the same sequence that was used for the Color Developing Solution addition.

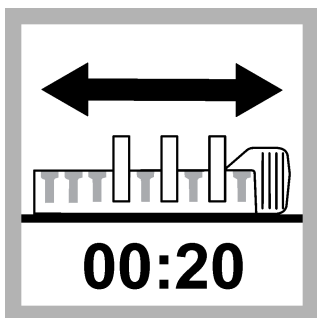

17. Slide the rack back and forth for 20 seconds. The blue solution color changes to yellow.

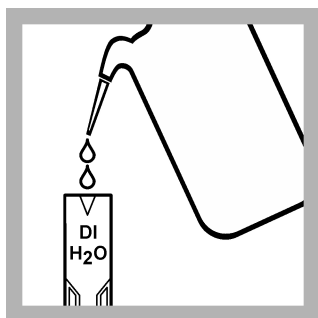

18. Put a mark on a zeroing cuvette to identify it as the blank. Fill the cuvette with deionized water.

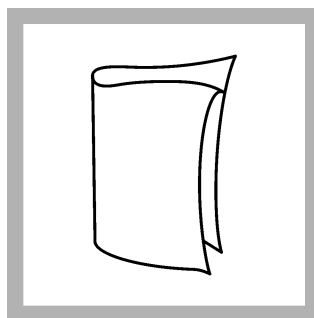

19. Clean all of the cuvettes.

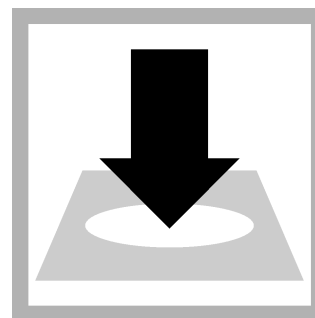

20. Insert the blank into the cell holder.

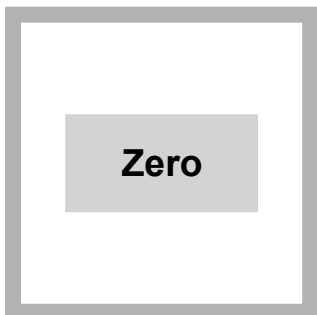

21. Push **ZERO**. The display shows 0.000 Abs.

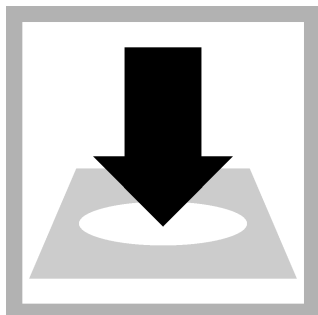

22. Insert the first calibrator into the cell holder.

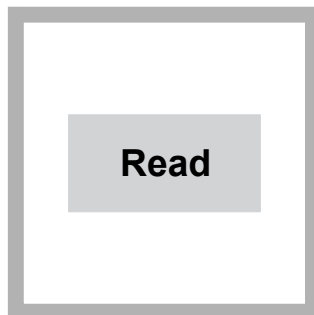

23. Push **READ**. Results show in Abs. Record the result.

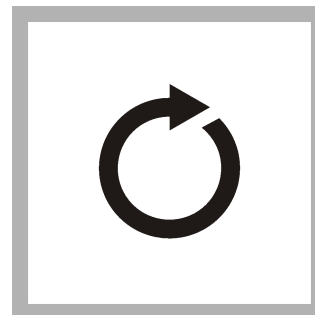

24. Read the absorbance values of the remaining calibrators and samples. Record the results. Refer to [Interpret and report the results](#) on page 5.

Use of the 1-cm MicroCuvette rack

Use the MicroCuvette rack to get accurate and precise results for the immunoassay procedure during the analysis of several samples at a time. Refer to [Figure 1](#).

Insert the cuvettes in the rack—Use the MicroCuvette rack to securely hold cuvettes that are set in the rack. Before the procedure starts, identify each cuvette with a sample or a calibrator number. Correctly insert the cuvettes in the rack. Do not force the cuvettes into the rack because the sample can spill or the cuvettes can be difficult to remove. The cuvettes must stay in position if the rack is inverted and carefully tapped.

Mix the sample—Put the rack on a hard, flat surface that is at least twice the length of the rack. Refer to [Figure 1](#). Hold one end of the rack, then vigorously slide the rack back and forth along its axis for 30 seconds. The rack moves through a distance equal to its own length in each direction.

Figure 1 MicroCuvette rack

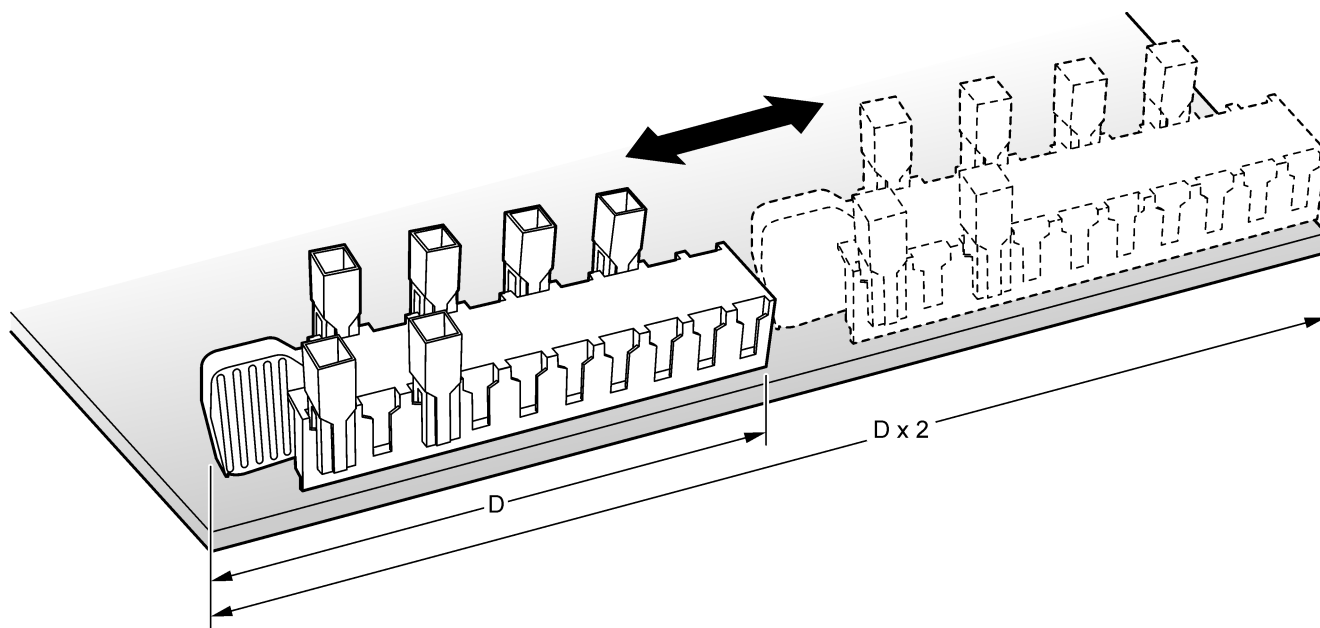

Interpret and report the results

There is an inverse relationship between the concentration of atrazine and the absorbance reading. In other words, the higher the reading, the lower the concentration of atrazine. Refer to [Table 2](#).

Table 2 Relative atrazine concentration

If the sample absorbance reading is...	then the sample concentration is...
Smaller than the calibrator reading	Larger than the calibrator reading
Larger than the calibrator reading	Smaller than the calibrator reading

For example, if the readings are:

- 0.5 ppb atrazine Calibrator: 0.475 Abs
- 3.0 ppb atrazine Calibrator: 0.245 Abs
 - Sample 1: 0.140 Abs
 - Sample 2: 0.300 Abs
 - Sample 3: 0.550 Abs

The interpretation for a sample:

- Sample 1: The sample reading is smaller than the readings for both calibrators. The sample concentration of atrazine is larger than 0.5 ppb and 3.0 ppb.
- Sample 2: The sample reading is between the readings for the calibrators. The sample concentration of atrazine is between 0.5 and 3.0 ppb.
- Sample 3: The sample reading is larger than the readings for both calibrators. The sample concentration is smaller than 3.0 and 0.5 ppb.

Reagent storage and handling

1. Always wear gloves and eyewear for protection.
2. For long-term storage, make sure that the reagents are not in direct sunlight. Keep the reagent set at 4 °C (39.2 °F) when not in use. Warm the reagents to room temperature before use.

3. When not in use, seal the foil pouch that contains the antibody cuvettes.
4. If the Stop Solution is in contact with the eyes, rinse fully for 15 minutes with cold water and get immediate medical help.

Sensitivity

The immunoassay procedure cannot detect the difference between some triazines and metabolites. The immunoassay procedure can sense the presence of triazines and metabolites, but the test sensitivity is different for individual compounds. [Table 3](#) shows the required concentration for detection of some chemicals. [Table 4](#) shows compounds that are not detected at 10,000 ppb.

Table 3 Required concentrations for selected chemicals

Compound	Concentration to give a positive result at 3 ppb (in ppb)
Ametryne	1
Atrazine	3
Atrazine, de-ethylated	115
Atrazine, de-isopropyl	714
Cyanazine	460
Cyromazine	1200
Prometon	8
Prometryne	0.7
Propazine	2.3
Simetryne	5.4
Simazine	37
Terbutylazine	91
Terbutryne	8.3

Table 4 Compounds tested but not detected up to 10,000 ppb

Alachlor	2, 4-D
Aldicarb	Diaminoatrazine
Carbendazim	Melamine
Carbofuran	Metolachlor

High sample concentrations

For higher levels of atrazine, dilute the sample and compare the results to the 0.1 ppb Calibrator. Select the applicable sample volume from [Table 5](#). Put the sample in a graduated mixing cylinder, then dilute the sample to 50 mL with deionized water.

Table 5 Sample volume and concentration

mL sample	Representative concentration with the 0.1 ppb calibrator
0.5	10 ppb
1.0	5 ppb
2.5	2 ppb
5.0	1 ppb

Example: Dilute 2.5 mL of sample to 50 mL with deionized water. Complete the procedure, then use the diluted sample with the 0.1 ppb calibrator. If the absorbance of

the diluted sample is smaller than the 0.1 ppb calibrator, then the concentration of the original sample is larger than 2 ppb.

Summary of method

Immunoassay tests use antigen/antibody reactions to detect specific organic compounds in water and soil. The walls of plastic cuvettes are layered with antibodies that are specific for atrazine. The antibodies selectively remove atrazine from complex sample matrices. A prepared sample and a reagent with enzyme-conjugate molecules (analyte molecules attached to molecules of an enzyme) are added to the Antibody Cuvettes. During incubation, enzyme-conjugate molecules and atrazine compete for binding sites on the antibodies. Samples with higher levels of analyte have more antibody sites occupied by the analyte and fewer antibody sites occupied by the enzyme-conjugate molecules.

After incubation, the sample and unbound enzyme conjugate are rinsed from the cuvette and a color-development reagent is added. The enzyme in the conjugate catalyzes the development of color. Thus, there is an inverse relationship between color intensity and the amount of atrazine in the sample. The resulting color is then compared with a calibrator to determine if the analyte concentration in the sample is larger or smaller than the threshold levels. The atrazine concentration is inversely proportional to the color development—the lighter the color, the higher the atrazine concentration. The test results are measured at 450 nm.

Consumables and replacement items

Required reagents

Description	Quantity/Test	Unit	Item no.
Atrazine reagent set	1	20 cuvettes	2762700
Water, deionized	varies	500 mL	27248

Required apparatus

Description	Quantity/test	Unit	Item no.
Caps, flip spout (for 500-mL deionized water bottle)	1	2/pkg	2581802
Marker, laboratory	1	each	2092000
Gloves, nitrile, medium	1	100/pkg	2550502
Pipet, TenSette [®] , 0.1–1.0 mL	1	each	1970001
Pipet Tips, for TenSette [®] Pipet, 0.1–1.0 mL	2	50/pkg	2185696
Rack, for 1-cm Micro Cuvettes	1	each	4879900
Safety goggles, vented	1	each	2550700
Wipes, disposable	1	280/pkg	2097000

Optional reagents and apparatus

Description	Unit	Item no.
Atrazine Reagent Set	100 cuvettes	2762710
Graduated mixing cylinder, 25-mL	each	2636340
Graduated mixing cylinder, 50-mL	each	2636341



FOR TECHNICAL ASSISTANCE, PRICE INFORMATION AND ORDERING:

In the U.S.A. – Call toll-free **800-227-4224**

Outside the U.S.A. – Contact the **HACH office or distributor serving you.**

On the Worldwide Web – www.hach.com; E-mail – techhelp@hach.com

HACH COMPANY
WORLD HEADQUARTERS
Telephone: (970) 669-3050
FAX: (970) 669-2932