



DOC342.52.80488

TU5200

08/2023, Edition 7

User Manual

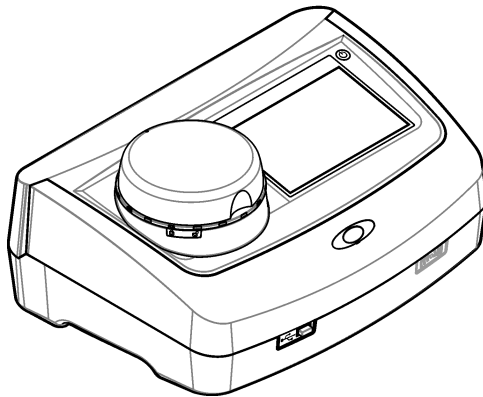

Section 1 Specifications	3
Section 2 General information	4
2.1 Safety information	4
2.1.1 Use of hazard information	4
2.1.2 Precautionary labels	5
2.1.3 Class 2 laser product	5
2.1.4 RFID module	6
2.1.4.1 Safety information for RFID modules	6
2.1.4.2 FCC conformance for RFID	7
2.1.5 Compliance and certification	7
2.2 Product overview	8
2.3 Product components	8
Section 3 Installation	9
3.1 Installation guidelines	9
3.2 Connect to external devices (optional)	9
Section 4 User interface and navigation	10
Section 5 Startup	11
Section 6 Operation	12
6.1 Configuration	12
6.1.1 Configure the instrument settings	12
6.1.1.1 Change the language	13
6.1.2 Add operator IDs	13
6.1.2.1 Configure an operator RFID tag (optional)	14
6.1.3 Add sample IDs	14
6.1.3.1 Import sample IDs (optional)	14
6.1.4 Configure the measurement settings	15
6.1.5 Set the acceptance range	15
6.1.6 Set up a LAN connection	16
6.1.6.1 Connect to an FTP server or Netdrive	17
6.1.6.2 Connect to a network printer	17
6.1.6.3 Connect to an sc controller	17
6.2 Measurement	18
6.2.1 Sample collection	18
6.2.2 Prevent vial contamination	18
6.2.3 Prepare a sample vial	19
6.2.4 Put the vial in the instrument	20
6.2.5 Measure the sample	21
6.2.6 Compare process and laboratory measurements	21
6.2.6.1 Collect a grab sample	21
6.2.6.2 Compare measurements with RFID	21
6.2.6.3 Compare measurements with Link2SC	22
6.3 Show the recorded data	24
6.4 Show the instrument information	25
Section 7 Calibration	26
7.1 Configure the calibration settings	26

Table of Contents

7.2 Calibrate the instrument	26
Section 8 Verification	28
8.1 Configure the verification settings	28
8.2 Do a calibration verification	28
Section 9 Maintenance	28
9.1 Clean spills	29
9.2 Clean the instrument	29
9.3 Clean a sample vial	29
9.4 Clean the vial compartment	30
Section 10 Troubleshooting	30
10.1 Remove air bubbles from the sample	34
10.2 Condensation	34
Section 11 Replacement parts and accessories	34

Section 1 Specifications

Specifications are subject to change without notice.

Specification	Details
Measurement method	Nephelometry with the scattered light collected at a 90° angle to the incident light and 360° around the sample vial.
Primary compliance method	EPA approved Hach Method 10258 ¹
Dimensions (W x D x H)	41 x 28 x 12.5 cm (16 x 11 x 7.7 in.)
Weight	2.37 kg (5.23 lb)
Enclosure	IP20
Protection class	Instrument: III; Power supply: I
Pollution degree	2
Overvoltage category	II
Power requirements	Instrument: 15 VDC, 2 A; Power supply: 100–240 VAC ± 10%, 50/60 Hz
Operating temperature	10 to 40 °C (50 to 104 °F)
Storage temperature	–30 to 60 °C (–22 to 140 °F)
Humidity	5 to 95% relative humidity, non-condensing
Environmental conditions	Indoor use
Altitude	2000 m (6562 ft) maximum
Display	17.8 mm (7 in.) color touch screen
Laser	Class 2 laser product: Contains a non user-serviceable class 2 laser.
Optical light source	650 nm, maximum 0.43 mW
Measurement units	NTU, FNU, TE/F, FTU, EBC, mg/L, mNTU ² or mFNU
Range	0 to 700 NTU, FNU, TE/F, FTU; 0 to 100 mg/L; 0 to 175 EBC
Accuracy	± 2% of reading plus 0.01 NTU from 0 to 40 NTU ± 10% of reading from 40 to 700 NTU based on Formazin primary standard at 25 °C (77 °F)
Linearity	Better than 1% for 0 to 40 NTU on Formazin at 25 °C (77 °F)
Precision	< 40 NTU: 0.002 NTU or 1% (the larger value); > 40 NTU: 3.5% based on Formazin primary standard at 25 °C (77 °F)
Stray light	< 0.01 NTU

¹ <http://www.hach.com>

² 1 mNTU = 0.001 NTU

Specification	Details
Calibration options	<p>StabiCal[®]: 1-point calibration (20 NTU) for 0 to 40 NTU measurement range; 2-point calibration (20 and 600 NTU) for 0 to 700 NTU (full) measurement range</p> <p>Formazin: 2-point calibration (20 NTU and dilution water) for 0 to 40 NTU measurement range; 3-point calibration (20 NTU, 600 NTU and dilution water) for 0 to 700 NTU (full) measurement range</p> <p>Degrees: 3-point calibration (20 and 100 mg/L and dilution water) for 0 to 100 mg/L (full) measurement range</p> <p>SDVB: 3-point calibration (20 NTU, 600 NTU and dilution water) for 0 to 700 NTU (full) measurement range</p> <p>Custom: 2- to 6-point custom calibration for a measurement range of 0 NTU to the highest calibration point.</p>
Verification options	Glass verification rod (secondary turbidity standard) < 0.1 NTU, StabiCal or Formazin (0.1 to 40 NTU)
Verification (RFID or Link2SC [®])	Process and laboratory measurements are compared with RFID or Link2SC for verification of the measurement value.
Certifications	CE compliant; US FDA accession number: 1420493-xxx. This product complies with IEC/EN 60825-1 and to 21 CFR 1040.10 in accordance with Laser Notice No. 50. Australian RCM.
Warranty	1 year (EU: 2 years)

Section 2 General information

In no event will the manufacturer be liable for damages resulting from any improper use of product or failure to comply with the instructions in the manual. The manufacturer reserves the right to make changes in this manual and the products it describes at any time, without notice or obligation. Revised editions are found on the manufacturer's website.

2.1 Safety information

The manufacturer is not responsible for any damages due to misapplication or misuse of this product including, without limitation, direct, incidental and consequential damages, and disclaims such damages to the full extent permitted under applicable law. The user is solely responsible to identify critical application risks and install appropriate mechanisms to protect processes during a possible equipment malfunction.

Please read this entire manual before unpacking, setting up or operating this equipment. Pay attention to all danger and caution statements. Failure to do so could result in serious injury to the operator or damage to the equipment.

Make sure that the protection provided by this equipment is not impaired. Do not use or install this equipment in any manner other than that specified in this manual.

2.1.1 Use of hazard information

▲ DANGER

Indicates a potentially or imminently hazardous situation which, if not avoided, will result in death or serious injury.

▲ WARNING

Indicates a potentially or imminently hazardous situation which, if not avoided, could result in death or serious injury.

▲ CAUTION







Indicates a potentially hazardous situation that may result in minor or moderate injury.

NOTICE

Indicates a situation which, if not avoided, may cause damage to the instrument. Information that requires special emphasis.

2.1.2 Precautionary labels



Read all labels and tags attached to the instrument. Personal injury or damage to the instrument could occur if not observed. A symbol on the instrument is referenced in the manual with a precautionary statement.

	Electrical equipment marked with this symbol may not be disposed of in European domestic or public disposal systems. Return old or end-of-life equipment to the manufacturer for disposal at no charge to the user.
	This symbol, if noted on the instrument, references the instruction manual for operation and/or safety information.
	This symbol indicates the need for protective eye wear.
	This symbol indicates a laser device is used in the equipment.
	This symbol identifies a risk of chemical harm and indicates that only individuals qualified and trained to work with chemicals should handle chemicals or perform maintenance on chemical delivery systems associated with the equipment.
	This symbol indicates radio waves.

2.1.3 Class 2 laser product

⚠ DANGER

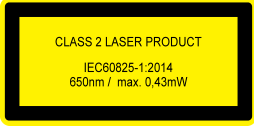
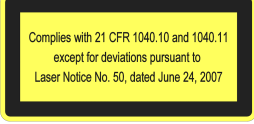
	Personal injury hazard. Never remove covers from the instrument. This is a laser-based instrument and the user risks injury if exposed to the laser.
-------------------------------------------------------------------------------------	------------------------------------------------------------------------------------------------------------------------------------------------------

 <p>CLASS 2 LASER PRODUCT IEC60825-1:2014 650nm / max. 0,43mW</p>	<p>Class 2 laser product, IEC60825-1:2014, 650 nm, maximum 0.43 mW Location: Rear of the instrument.</p>
 <p>Complies with 21 CFR 1040.10 and 1040.11 except for deviations pursuant to Laser Notice No. 50, dated June 24, 2007</p>	<p>Conforms to U.S. regulations 21 CFR 1040.10 and 1040.11 in accordance with Laser Notice No. 50. Location: Rear of the instrument.</p>
 <p>CAUTION - CLASS 2 LASER RADIATION WHEN OPEN, DO NOT STARE INTO BEAM. ACHTUNG - LASERSTRAHLUNG KLASSE 2 WENN GEÖFFNET, NICHT IN DEN STRAHLENBLICKEIN ATTENTION - RAYONNEMENT LASER CLASSE 2 SI OUVERT, NE PAS REGARDER DANS LE FAISCEAU</p>	<p>Caution—Class 2 laser radiation when the lid is open. Do not look into the laser beam. Location: Top of the vial compartment.</p>

This instrument is a Class 2 Laser product. There is only visible laser radiation when the instrument is defective and when the instrument lid is open. This product complies with EN 61010-1, "Safety Requirements for Electrical Equipment for Measurement, Control and Laboratory Use" and with IEC/EN 60825-1, "Safety of Laser Products" and with 21 CFR 1040.10 in accordance with Laser Notice No. 50. Refer to the labels on the instrument that supply laser information.

2.1.4 RFID module

Instruments with the optional RFID module receive and transmit information and data. The RFID module operates with a frequency of 13.56 MHz.

RFID technology is a radio application. Radio applications are subject to national conditions of authorization.

In case of doubt, contact the manufacturer.

2.1.4.1 Safety information for RFID modules

⚠ WARNING	
	Multiple hazards. Do not disassemble the instrument for maintenance. If the internal components must be cleaned or repaired, contact the manufacturer.

⚠ WARNING	
	Electromagnetic radiation hazard. Do not use the instrument in dangerous environments.

NOTICE	
This instrument is sensitive to electromagnetic and electromechanical interference. These interferences can have an effect on the analysis performance of this instrument. Do not put this instrument near equipment that can cause interference.	

Obey the safety information that follows to operate the instrument in accordance with local, regional and national requirements.

- Do not operate the instrument in hospitals and equivalent establishments or near medical equipment, such as pace makers or hearing aids.

- Do not operate the instrument near highly flammable substances, such as fuels, highly flammable chemicals and explosives.
- Do not operate the instrument near combustible gases, vapors or dust.
- Keep the instrument away from strong vibration or shock.
- The instrument can cause interference in immediate proximity to televisions, radios and computers.
- The warranty does not cover improper use or wear.

2.1.4.2 FCC conformance for RFID

This instrument may contain a registered radio frequency identification device (RFID). Refer to [Table 1](#) for the Federal Communications Commission (FCC) registration information.

Table 1 Registration information

Parameter	Value
FCC identification number (FCC ID)	YUH-QR15HL / YUH-Q152
IC	9278A-QR15HL / 9278A-Q152
Frequency	13.56 MHz

2.1.5 Compliance and certification

▲ CAUTION

This equipment is not intended for use in residential environments and may not provide adequate protection to radio reception in such environments.

Canadian Radio Interference-Causing Equipment Regulation, ICES-003, Class A:

Supporting test records reside with the manufacturer.

This Class A digital apparatus meets all requirements of the Canadian Interference-Causing Equipment Regulations.

Cet appareil numérique de classe A répond à toutes les exigences de la réglementation canadienne sur les équipements provoquant des interférences.

FCC Part 15, Class "A" Limits

Supporting test records reside with the manufacturer. The device complies with Part 15 of the FCC Rules. Operation is subject to the following conditions:

1. The equipment may not cause harmful interference.
2. The equipment must accept any interference received, including interference that may cause undesired operation.

Changes or modifications to this equipment not expressly approved by the party responsible for compliance could void the user's authority to operate the equipment. This equipment has been tested and found to comply with the limits for a Class A digital device, pursuant to Part 15 of the FCC rules. These limits are designed to provide reasonable protection against harmful interference when the equipment is operated in a commercial environment. This equipment generates, uses and can radiate radio frequency energy and, if not installed and used in accordance with the instruction manual, may cause harmful interference to radio communications. Operation of this equipment in a residential area is likely to cause harmful interference, in which case the user will be required to correct the interference at their expense. The following techniques can be used to reduce interference problems:

1. Disconnect the equipment from its power source to verify that it is or is not the source of the interference.
2. If the equipment is connected to the same outlet as the device experiencing interference, connect the equipment to a different outlet.
3. Move the equipment away from the device receiving the interference.

4. Reposition the receiving antenna for the device receiving the interference.
5. Try combinations of the above.

2.2 Product overview

The TU5200 turbidimeter measures low turbidity mostly in finished drinking water applications. This laboratory instrument is factory calibrated and measures scattered light at an angle of 90° in a 360° radius around the axis of the incident light beam. Use the touch screen to operate the instrument. Refer to [Figure 1](#).

An optional RFID module is available. [Figure 1](#) shows the RFID module. The RFID module lets process and laboratory turbidity measurements be easily compared.

Instructional videos are available in the support section of the manufacturer's website.

For the accessories, refer to [Replacement parts and accessories](#) on page 34.

Figure 1 Product overview

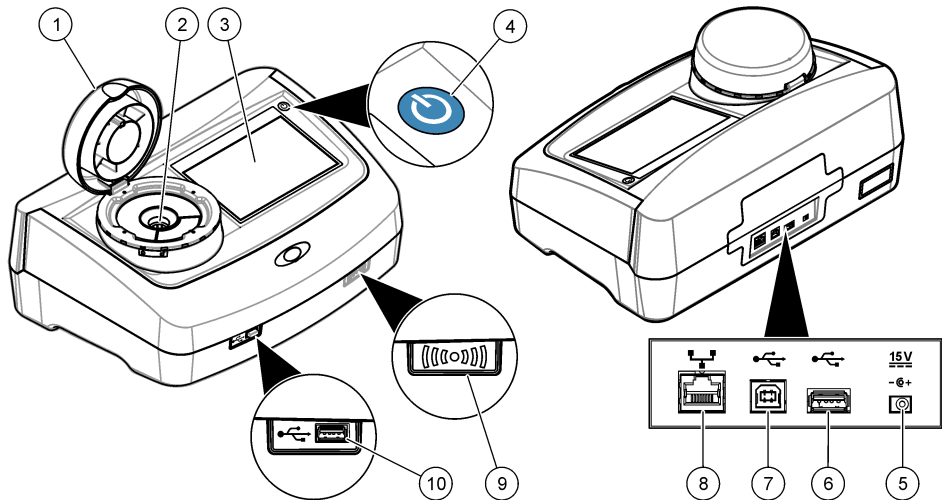

1 Lid	6 USB port type A
2 Vial compartment	7 USB port type B
3 Display	8 Ethernet port for LAN connection
4 Power button	9 RFID module indicator (optional)
5 Power supply connection	10 USB port type A

2.3 Product components

Make sure that all components have been received. Refer to [Figure 2](#). If any items are missing or damaged, contact the manufacturer or a sales representative immediately.

Figure 2 Product components

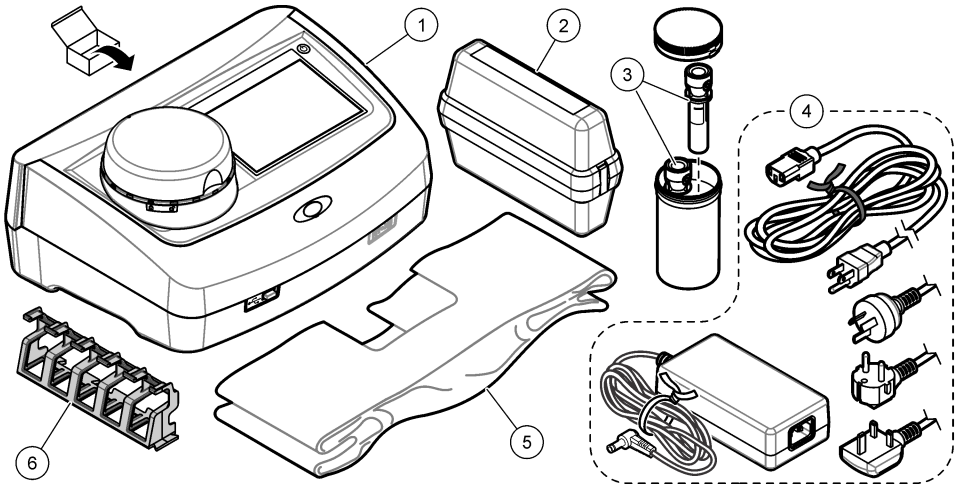

1 TU5200	4 Power supply
2 StablCal kit, sealed vials with RFID (10, 20 and 600 NTU)	5 Dust cover
3 Sample vials	6 Vial stand

Section 3 Installation

⚠ CAUTION



Multiple hazards. Only qualified personnel must conduct the tasks described in this section of the document.

This instrument is rated for an altitude of 3100 m (10,710 ft) maximum. Use of this instrument at an altitude higher than 3100 m can slightly increase the potential for the electrical insulation to break down, which can result in an electric shock hazard. The manufacturer recommends that users with concerns contact technical support.

3.1 Installation guidelines

Install the instrument:

- On a level surface
- In a clean, dry, well ventilated, temperature controlled location
- In a location with minimum vibrations that has no direct exposure to sunlight
- In a location where there is sufficient clearance around it to make connections and to do maintenance tasks
- In a location where the power button and power cord are visible and easily accessible

3.2 Connect to external devices (optional)

NOTICE

Network and access point security is the responsibility of the customer that uses the wireless instrument. The manufacturer will not be liable for any damages, inclusive however not limited to indirect, special, consequential or incidental damages, that have been caused by a gap in, or breach of network security.

The instrument has three USB 1.1 ports and one Ethernet port. Refer to [Figure 1](#) on page 8.

USB type A port—Connect to a printer, barcode handset scanner, USB flash drive, keyboard³ or SIP 10 module.

USB type B port—Connect to a PC.

Ethernet port—Connect to a LAN with a shielded cable (e.g., STP, FTP, S/FTP). The maximum length of the shielded cable is 20 m (65.6 ft). To identify if a LAN connection is necessary, refer to [Set up a LAN connection](#) on page 16.

Note: USB cables must not be longer than 3 m (9.8 ft).

Section 4 User interface and navigation

The instrument display is a touch screen. Only use a clean, dry finger tip to navigate the functions of the touch screen. Do not use writing tips of pens or pencils or other sharp objects to make selections on the screen or damage to the screen will occur.

Refer to [Figure 3](#) for an overview of the home screen.

Figure 3 Display overview

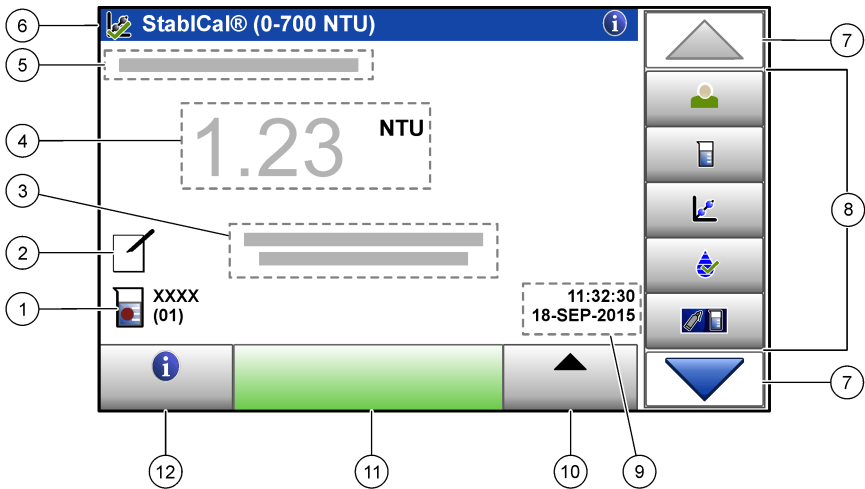











1 Sample ID and measurement number ⁴	7 UP/DOWN navigation arrows
2 User comments	8 Sidebar menu (refer to Table 2)
3 Instructions	9 Time and date
4 Turbidity value, unit and reading mode	10 Options button
5 Warning or error message	11 Read button
6 Calibration status icon and calibration curve	12 Information (help) button

³ As an alternative to the touchscreen, use a keyboard to enter text into text boxes on the display (e.g., passwords and sample IDs).

⁴ The measurement number increases by one each time a measurement is completed.

Table 2 Sidebar menu icons

Icon	Description
 Login	Logs in or logs out an operator. To log in, select an operator ID and then push Login . To log out, push Logout . Note: When an operator is logged in, the Login icon changes to the icon selected for the operator ID (e.g., fish, butterfly or soccer ball) and the text "Login" changes to the operator ID.
 Sample ID	Selects the sample ID.
 Calibration	Starts a calibration.
 Verification	Starts a verification.
 Link2SC	Compares process and laboratory measurements.
 Data Log	Shows the reading log, calibration log, verification log and compare log. Refer to Show the recorded data on page 24.
 Setup	Configures the instrument settings. Refer to Configure the instrument settings on page 12.
 Diagnostics	Shows the firmware information, instrument backup, instrument updates, signaling information and factory service data.
 Timer	Sets a timer.
 HACRP	Goes to the manufacturer's website for the latest software versions and user manual when the instrument has a LAN connection.
 Documents	Shows the user manual and video(s) for the instrument.

Section 5 Startup

▲ CAUTION



Personal injury hazard. Never remove covers from the instrument. This is a laser-based instrument and the user risks injury if exposed to the laser.

⚠ CAUTION



Personal injury hazard. Do not look into the vial compartment when the instrument is connected to power.

Refer to the illustrated steps that follow to connect power to the instrument and start the instrument. When the language menu shows, select the language and then push **OK**. The self-check will start.

Note: To change the language after the initial startup, refer to [Change the language](#) on page 13.

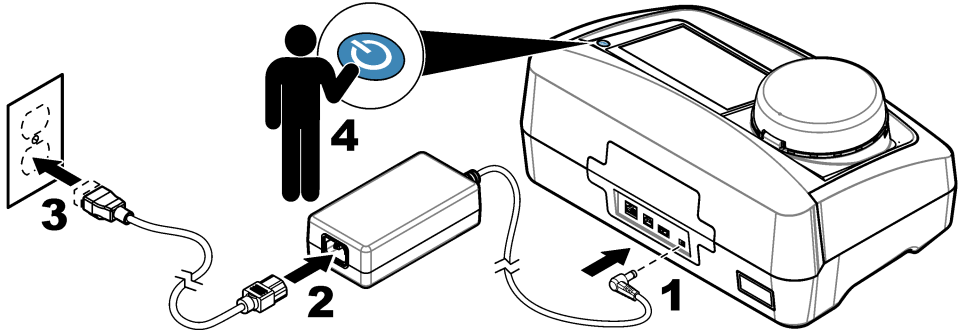

Section 6 Operation

6.1 Configuration

6.1.1 Configure the instrument settings

1. Push ▼ two times, then push **Setup**.
2. Select an option.

Option	Description
Location	Sets the location name of the instrument. The location is saved with measurements to the data log.
Date & Time	Sets the date format, the time format and the date and time. Enter the current date and time. Date Format —Sets the date format. Options: dd-mmm-yyyy (default), yyyy-mm-dd, dd-mm-yyyy or mm-dd-yyyy. Time Format —Sets the time format. Options: 12 or 24 hours (default).
Security	Enables or disables password protection for the settings and tasks in the security list. Security Password —Sets or changes the security (administrator) password (10 characters maximum). Passwords are case sensitive. Security List —Sets the security level for each setting and task in the security list. <ul style="list-style-type: none">• Off—All operators can change the setting and or do the task.• One key—Only operators with a one-key or two-key security level can change the setting or do the task. Refer to Add operator IDs on page 13.• Two keys—Only operators with a two-key security level can change the setting or do the task. <p>Note: The Security setting is not set to on until Close is pushed.</p>
Sound Settings	Enables or disables the sound settings for individual events. Sets the sound volume for each event (1 to 10). To enable or disable all of the sound settings, select All and then push Setup .

Option	Description
Network & Peripherals	Shows the connection status of the devices that are directly connected to the instrument and connected to the instrument by LAN (local area network). <ul style="list-style-type: none"> • Printer—Local printer or network printer • Network—LAN connection • Controller—sc controller(s) • PC • USB Memory—USB flash drive • Keyboard
Power Management	Sets when the instrument is automatically set to sleep mode or off after a period of no activity. Sleep Timer —Sets when the instrument is set to sleep mode. Options: OFF, 30 minutes, 1 (default), 2 or 12 hours. Power-Off Timer —Sets when the instrument is set to off. Options: OFF, 2, 6, 12 (default) or 24 hours.

6.1.1.1 Change the language

NOTICE

Wait a minimum of 20 seconds after the power is set to off before the power is set to on again or damage to the instrument can occur.

To change the language after the initial startup, do the steps that follow.

1. Set the instrument to off.
2. Set the instrument to on.
3. During startup, touch the display until the language menu shows (approximately 45 seconds).
4. When the language menu shows, select the language and then push **OK**.

6.1.2 Add operator IDs

Add a unique operator ID for each person who will measure samples (30 maximum). Select an icon, operator password and security level for each operator ID.

1. Push **Login**.
2. Push **Options>New**.
3. Enter a new operator ID (10 characters maximum), then push **OK**.
4. Push the **LEFT** and **RIGHT** arrows to select the icon for the operator ID (e.g., fish, butterfly or soccer ball).
5. Push **Operator Password**, then enter a password for the operator ID.

Note: Passwords are case sensitive.
6. Push **Security Level**, then select the security level for the operator ID.
 - **Off**—The operator cannot change the settings or do the tasks in the Security settings that have a security level of one key or two keys.
 - **One key**—The operator can change all the settings and do all the tasks in the Security settings that have a security level of off or one key.
 - **Two keys**—The operator can change all the settings and do all the tasks in the Security settings.

Note: Before a security level can be selected, the Security setting must be set to on. Refer to [Configure the instrument settings](#) on page 12.
7. Push **OK>Close**.
8. To edit an operator ID, select the operator ID and then push **Options>Edit**.
9. To delete an operator ID, select the operator ID and then push **Options>Delete>OK**.

6.1.2.1 Configure an operator RFID tag (optional)

To use an operator RFID tag to log in to the instrument, save the applicable operator ID to an operator RFID tag as follows:

1. Push **Login**.
2. Select the operator ID, then push **Options>Initialize RFID Tag**.
3. Enter the password for the operator ID as necessary.
4. Complete the steps that show on the display.
5. Push **OK** to replace the operator ID on the RFID tag with a new operator ID if applicable.
6. Push **Close**.
7. Put the operator RFID tag in front of the RFID module to log in.

6.1.3 Add sample IDs

Add a unique sample ID for each sample (100 maximum). The sample ID identifies the sample location or other sample specific information.

As an alternative, import sample IDs from a spreadsheet file to the instrument. Refer to [Import sample IDs \(optional\)](#) on page 14.

Note: When a sample bottle with a sample RFID sticker is put in front of the RFID module, the sample ID is automatically added to the instrument and selected on the instrument.

1. Push **Sample ID**.
2. Push **Options>New**.
3. Enter a new sample ID (20 characters maximum).
4. If the sample bottle has a barcode that identifies the sample ID, read the barcode with a barcode handset scanner that is connected to the instrument. The barcode is added to the sample ID.
5. Push **OK**.
6. Select an option.

Option	Description
Add Date/Time	Adds the data and time that the sample was collected to the sample ID (optional). The date and time entered for each sample ID show on the Sample ID menu.
Add Number	Adds a measurement number to the sample ID (optional). Select the first number used for the measurement number (0 to 999). The measurement number shows in parenthesis after the sample ID on the home screen. Refer to Figure 3 on page 10.
Add Color	Adds a colored circle to the sample ID icon (optional). The sample ID icon shows before the sample ID on the home screen. Refer to Figure 3 on page 10.

7. Push **OK>Close**.
8. To edit a sample ID, select the sample ID and then push **Options>Edit>OK**.
9. To delete a sample ID, select the sample ID and then push **Options>Delete>OK**.

6.1.3.1 Import sample IDs (optional)

Import sample IDs from a spreadsheet file on a USB flash drive.

Note: Imported sample IDs cannot be edited.

1. On a PC, make a new spreadsheet file.
2. At the top of the first column, enter #Row Number;#Sample ID;#Date and Time for the heading.
3. Enter the information for one sample ID in each row after the heading. Make sure that there are no spaces.

Example:

#Row Number;#Sample ID;#Date and Time

1;Aeration;13.09.2015 10:03

2;Outlet;13.09.2015 06:30

3;Feed;13.09.2015 18:00

Note: *The date of sample collection is optional.*

4. Make a new folder on a USB flash drive. Give the folder the name "SampleID".
5. Save the spreadsheet file to the SampleID folder as a CSV (comma-separated value) or TXT (text) file.
6. Connect the USB flash drive to a USB port on the instrument.
7. On the instrument, push **Sample ID>Options>Import Sample ID list**.
The filename of the spreadsheet file(s) in the SampleID folder shows.
8. Select the applicable spreadsheet file, then push **OK**.
The sample IDs are added to the instrument.

6.1.4 Configure the measurement settings

Select the reading mode, measurement units, data log settings, resolution and more.

1. At the main reading screen, push **Options>Reading Setup**.
2. Select an option.

Option	Description
Reading	Sets the reading mode to single, continuous or minimum mode. Default: Single. Single —The measurement stops when the reading is stable. Continuous —The measurement continues until the user pushes Done . Minimum Mode —Set to on when a process and laboratory measurement are compared and the process measurement is a lower NTU range. Removes the effect of non-representative particles in the grab sample. Signal Avg —The turbidity reading that shows on the display is an average of the values measured during the time interval selected. Options: For single measurement mode, 5 to 15 seconds. For continuous measurement mode, 5 to 90 seconds.
Unit	Selects the measurement units that show on the display and that are recorded to the data log. Options: NTU, FNU, TE/F, FTU, EBC, mNTU or mFNU. Default: NTU).
Data Log Setup	Sets the data log settings. Auto Store —Measurement data is automatically recorded in the reading log. Default: On. When not selected, push Options>Store to record the current measurement to the reading log as necessary. Send Data Format —Sets the output format of measurement data that is sent to external devices (CSV or XML). Default: XML. Print Format —Sets the output format of measurement data that is sent to a printer (Quick Print or Detailed Print (GLP)). Comments —Lets users add comments to log entries. Auto Send —Measurement data is automatically sent to all of the devices (e.g., printer, USB flash drive and FTP server) that are connected to the instrument after each measurement.
Resolution	Selects the number of decimal places that show on the display. Options: 0.001 (default) or 0.0001.
Bubble Reject	Sets the bubble reject to on (default) or off. When set to on, high turbidity readings caused by bubbles in the sample are not shown or saved to the data log.
Close lid to start reading	Enables or disables the instrument to start a measurement automatically when the lid is closed. Default: On. A measurement is only done when there is a sample vial in the instrument.

6.1.5 Set the acceptance range

Before process and laboratory measurements are compared on the instrument, set the acceptance range for the compare results. The acceptance range is the maximum difference permitted between the process and laboratory measurements.

1. Push **LINK2SC**.
2. Push **Options>Compare Setup**.
3. Push **Acceptance Range>Unit**.

4. Select an option.

Option	Description
%	Sets the acceptance range to a percentage (1 to 99%).
NTU	Sets the acceptance range to NTU units (0.015 to 100.00 NTU).

5. Push **Value**, then enter the acceptance range.

6.1.6 Set up a LAN connection

NOTICE

Network and access point security is the responsibility of the customer that uses the wireless instrument. The manufacturer will not be liable for any damages, inclusive however not limited to indirect, special, consequential or incidental damages, that have been caused by a gap in, or breach of network security.

The manufacturer recommends that a network administrator does this task.

Set up a LAN connection at the instrument to do one or more of the tasks that follow.

- Show the manufacturer's website on the instrument.
 - Compare process and laboratory measurements with Link2SC.
 - Send data to a network printer that is SNMP enabled.
 - Send data to a specific folder on an FTP server.
 - Send data to a specific folder on a Netdrive.
 - Show the readings from an sc controller(s) on the instrument.
1. Connect the Ethernet port to a LAN with a shielded cable (e.g., STP, FTP, S/FTP).
Note: The maximum permitted length of the shield cable is 20 m (65.6 ft).
 2. Push ▼ two times, then push **Setup**.
 3. Push **Network & Peripherals**.
 4. Select Network, then push **Setup**.
 5. Select On.
 6. Push **TU5200 IP**.
 7. To get an IP address for the instrument from a DHCP server, do the steps that follow.
 - a. Select Automatic.
 - b. Push **OK** two times.
The IP address shows on the TU5200 IP menu icon.
 8. To manually enter an IP address for the instrument, do the steps that follow.
 - a. Select Fixed.
 - b. Push **IP-Address**, then enter the IP address.
 - c. Push **Default Gateway**, then enter the default gateway.
 - d. Push **Subnet Mask**, then enter the subnet mask.
 - e. Push **OK** two times.
The IP address shows on the TU5200 IP menu icon.
 9. To compare process and laboratory measurements with Link2SC, enter the IP address for the instrument in the sc controller as follows:
 - a. On the sc controller, select LINK2SC>CONFIGURE>IP ADDRESS.
 - b. Enter the IP address for the instrument.

6.1.6.1 Connect to an FTP server or Netdrive

Pre-requisites: Connect the instrument to a LAN. Refer to [Set up a LAN connection](#) on page 16. Connect the instrument to a folder on an FTP server or Netdrive to send data to that folder.

1. Push  two times, then push **Setup**.
2. Push **Network & Peripherals**.
3. Select Network, then push **Setup**.
4. Push **Network Server**.
5. To connect to a folder on an FTP server, do the steps that follow.
 - a. Select FTP.
 - b. Push **FTP Server**.
6. To connect to a folder on a Netdrive, do the steps that follow.
 - a. Select Netdrive.
 - b. Push **Netdrive Setup**.
7. Select an option.

Option	Description
IP-Address	Selects the IP address of the FTP server or Netdrive. Push IP-Address and enter the IP address of the FTP server or Netdrive.
Server Name	Selects the server name of the FTP server or Netdrive. Push Server Name and enter the server name of the FTP server or Netdrive.

8. Push **Data Folder**, then enter the name of the target folder that is on the FTP server or Netdrive.
9. Push **User**, then enter a user name that has read/write permissions for the target folder.
10. Push **Password**, then enter the password for the user name.
11. Push **OK** three times.

6.1.6.2 Connect to a network printer

Pre-requisites: Connect the instrument to a LAN. Refer to [Set up a LAN connection](#) on page 16. Connect a network printer to the instrument to send data to a remote (network) printer. Only network printers that are SNMP enabled and in the same sub network are found by the instrument.

1. Push  two times, then push **Setup**.
2. Push **Network & Peripherals**.
3. Select Printer, then push **Setup**.
4. Push **Network Printer**, then select On.
5. Push **Printer IP**, then select Automatic.
6. When the printer list shows, select a printer and then push **OK**.
7. Push **Resolution**, then select the printer resolution (100 or 150 dpi).
8. Push **Paper**, then select the paper size. Options: Letter, Legal, Executive or A4.
9. Push **OK** two times.

6.1.6.3 Connect to an sc controller

Pre-requisites: Connect the instrument to a LAN. Refer to [Set up a LAN connection](#) on page 16. Connect the instrument to one or more sc controllers that have a LAN connection⁵ to do the tasks that follow.

- Show the current readings from an sc controller(s).

⁵ Refer to the sc controller documentation to set up a LAN connection.

- Show previous readings from an sc controller(s) for the day, week or month in graph format.
- Show the current reading for one parameter from an sc controller in the sidebar menu.

Note: This task is not necessary to compare process and laboratory measurements with Link2SC.

1. Push ▼ two times, then push **Setup**.
2. Push **Network & Peripherals**.
3. Select Controller, then push **Setup**.
4. Push **Add**.
5. To enter the IP address of the sc controller, do the steps that follow.
 - a. Select IP-Address.
 - b. Push **IP-Address**, then enter the IP address of the sc controller.
6. To enter the host name of the sc controller, do the steps that follow.
 - a. Select Hostname.
 - b. Push **Hostname**, then enter the server name of the sc controller.
7. Push **Password**, then enter the password for the sc controller.
8. Push **OK>CLOSE>CLOSE**.
9. Select the channels (parameters) that show on the instrument as follows:
 - a. Push **Link2SC**.
 - b. Push **Process Monitoring>Add**.
 - c. Select the channel, then push **OK**.
The current reading and the previous readings for the channel show in graph format.
10. Do step 9 again to show more channels on the display as necessary.
11. To change the time interval that shows on the graph, push the graph and select Day, Week or Month.
12. To show the current reading for one of the channels in the sidebar menu, select the channel and then push the minimize icon at the top of the screen.
The current reading for the channel shows in the sidebar menu after the Verification icon.

6.2 Measurement

6.2.1 Sample collection

- Collect samples in clean glass or plastic bottles with tight-fitting caps.
- Rinse the container a minimum of three times with the sample.
- When collecting a sample from a water tap in a distribution system or treatment plant, turn the water on for at least five minutes, then collect the sample. Do not adjust the flow because this can add particles.
- When collecting a sample from a body of water (e.g., a stream or storage tank), collect at least one liter (1 quart) and fully mix before taking an aliquot for measurement. If the quality of the sample source is not constant, collect samples at many locations at different depths as necessary. Then, mix the samples together to prepare one sample for measurement.
- Fill the container. Let the container overflow with the sample and then immediately put the cap on the sample container so that there is no headspace (air) above the sample.
- Write the sample information on the container.
- Start analysis as soon as possible to prevent temperature changes, bacteria growth and settling.

6.2.2 Prevent vial contamination

NOTICE

Do not touch or scratch the glass of the sample vial. Contamination or scratches on the glass can cause measurement errors.

The glass must stay clean and have no scratches. Use a no-lint cloth to remove dirt, fingerprints or particles from the glass. Replace the sample vial when the glass has scratches.

Refer to [Figure 4](#) to identify where not to touch the sample vial. Always keep the sample vials in the vial stand to prevent contamination on the bottom of the vial.

Figure 4 Sample vial overview

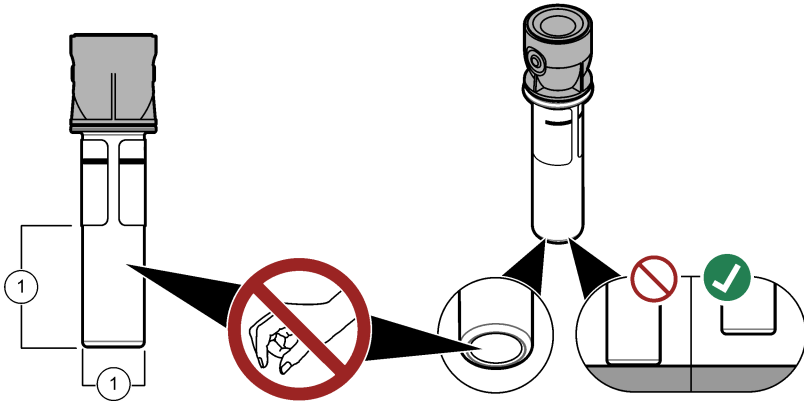

1 Measurement surface—Do not touch.

6.2.3 Prepare a sample vial

⚠ CAUTION



Chemical exposure hazard. Dispose of chemicals and wastes in accordance with local, regional and national regulations.

NOTICE

Always put a cap on the sample vial to prevent spills in the vial compartment.

Refer to the illustrated steps that follow to prepare a sample vial for measurement. Measure the sample immediately.

Note: If there is contamination in the sample vial after it is rinsed with the sample, clean the sample vial. Refer to [Clean a sample vial](#) on page 29.

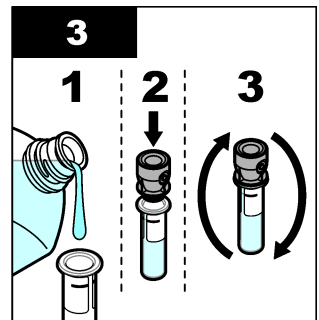
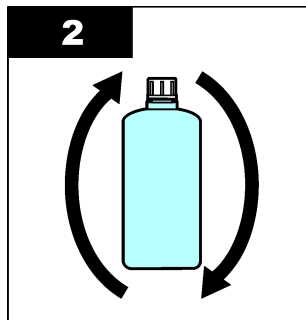
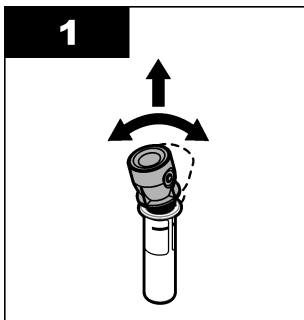

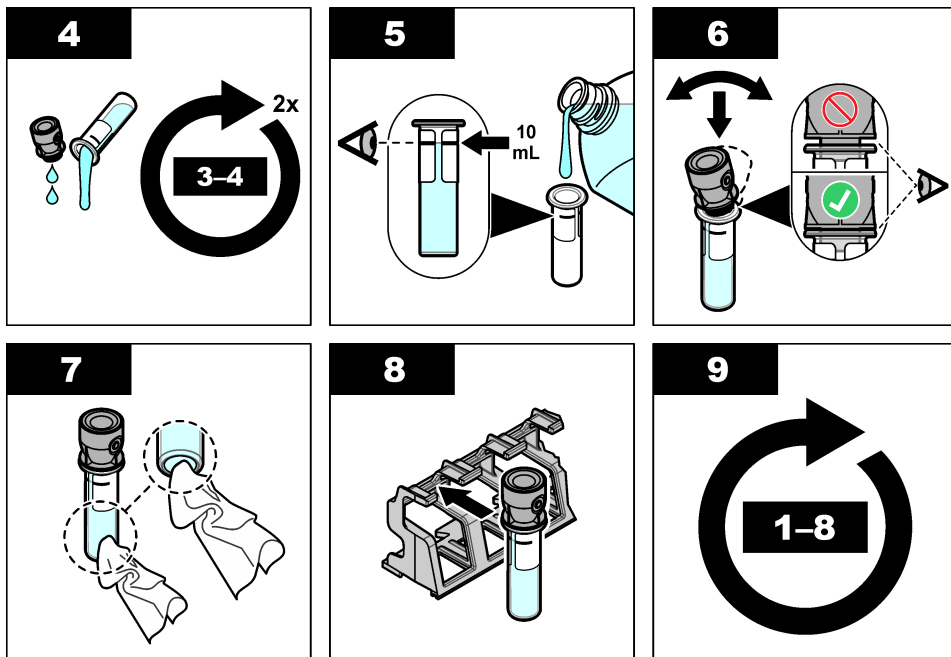

6.2.4 Put the vial in the instrument

⚠ CAUTION



Personal injury hazard. Never remove covers from the instrument. This is a laser-based instrument and the user risks injury if exposed to the laser.

⚠ CAUTION



Personal injury hazard. Do not look into the vial compartment when the instrument is connected to power.

NOTICE

Keep the lid closed to keep contamination out of the vial compartment.

1. Log in to the instrument as follows:

- Put an operator RFID tag in front of the RFID module or
- Push **Login**. Select the applicable operator ID, then push **Select**.

2. Select the sample ID as follows:

- Put the sample RFID sticker on the sample bottle in front of the RFID module or
- Push **Sample ID**. Select the applicable sample ID, then push **Select**.

Note: To add sample IDs to the instrument, refer to [Add sample IDs](#) on page 14.

3. Clean the sample vial with a no-lint cloth to remove contamination.
4. Dry the external surfaces of the vial with a no-lint cloth. Make sure to dry the bottom of the vial.
5. Put the sample vial in the vial compartment. Refer to the illustrated steps that follow.

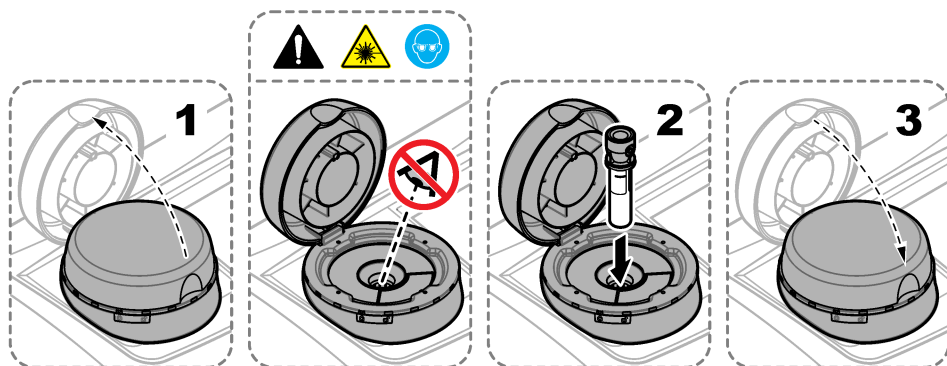

6.2.5 Measure the sample

1. Push **Read** if a measurement does not start automatically when the lid is closed.
2. When the measurement is complete, push **Options>Store** to record the measurement to the reading log as necessary.

Note: If the Auto Save setting is set to on, "Data Stored" shows on the display and the measurement is automatically recorded to the reading log.

3. To show the recorded measurements, push **Options>Reading Log**. Refer to [Show the recorded data](#) on page 24 for more options.
4. To send the measurement data to external devices that are connected to the instrument, push **Options>Send Data**. Refer to [Show the recorded data](#) on page 24 for more options.

Note: If the Auto Send settings is set to on, the measurement data is automatically sent to the external device(s) that is connected to the instrument.

6.2.6 Compare process and laboratory measurements

Compare process and laboratory measurements with RFID or Link2SC. Make sure that the process and lab instrument are calibrated with the same number of calibration points and with the same standards. Make sure that the calibrations are not expired.

6.2.6.1 Collect a grab sample

Collect a 100-mL sample (minimum) from the sample outlet tubing of the process instrument. Collect the sample in a clean glass bottle with a tight-fitting cap. Do not collect samples directly into a sample vial.

1. Rinse the glass bottle a minimum of three times with water from the sample outlet tubing of the process instrument. Let the bottle overflow with the sample.
2. Collect a 100-mL sample (minimum) in the glass bottle from the sample outlet tubing of the process instrument.
3. Put the cap on the sample bottle.
4. Analyze the grab sample immediately with the laboratory instrument to prevent settling, bacteria growth and temperature changes.

6.2.6.2 Compare measurements with RFID

When the process instrument and laboratory instrument have the optional RFID module, compare process and laboratory measurements with RFID.

Items to collect:

- TU5300 sc or TU5400 sc with the optional RFID module
- TU5200 with the optional RFID module
- TU5200 sample vials

- Glass sample bottle with a sample RFID sticker
- Operator RFID tag (optional)

1. At the process instrument, put the operator RFID tag (if available) near the RFID module.
2. Put a sample RFID sticker on the sample bottle.
3. Collect a grab sample. Refer to [Collect a grab sample](#) on page 21.
4. At the process instrument, put the RFID sticker that is on the sample bottle near the RFID module.

The instrument gives a sound signal. The status indicator light changes to blue.

The turbidity reading, operator ID (if available), location of the process instrument and the date and time are recorded on the RFID sticker.

5. Move the grab sample bottle to the laboratory instrument.
 6. On the TU5200, push **Options>Reading Setup**.
 7. Push **Bubble Reject**, then set bubble reject to on.
 8. If the grab sample is 1 NTU or less, push **Reading>Minimum Mode**, then select 60 seconds.
- Note:** *In minimum mode, readings are done continuously for 60 seconds when a measurement is done. The smallest reading within 60 seconds is saved to the data log.*
9. At the laboratory instrument, put the operator RFID tag (if available) near the RFID module to log in. Refer to [Figure 1](#) on page 8 for the location of the RFID module.
 10. Put the RFID sticker that is on the sample bottle near the RFID module.

The instrument gives a sound signal. The turbidity reading from the process instrument shows on the display.

11. Prepare a grab sample vial. Refer to [Prepare a sample vial](#) on page 19.
12. Measure the turbidity of the grab sample with the laboratory instrument. Refer to the TU5200 documentation.

If the difference between the process and laboratory measurements is not more than the selected acceptance range, "Measurement values match." shows on the display. Refer to [Set the acceptance range](#) on page 15 to select the acceptance range.

If "Measurement values do not match." shows on the display, click the link to show the troubleshooting steps.
13. To show the compare log, push **Options>Compare Log**. Refer to the TU5200 documentation for more options.
14. To send the verification data to external devices that are connected to the instrument, push **Options>Send Data**. Refer to the TU5200 documentation for more options.

6.2.6.3 Compare measurements with Link2SC

When the process instrument and laboratory instrument do not have the optional RFID module, compare the process and laboratory measurements with Link2SC.

Items to collect:

- TU5300 sc or TU5400 sc
- TU5200
- TU5200 sample vials
- SD card⁶ (or a LAN connection at the SC controller⁷ and the laboratory instrument⁸)
- USB adapter for the SD card (if used)

⁶ Refer to the SC controller documentation for the SD card requirements.

⁷ Refer to the SC controller documentation to set up a LAN connection at the SC controller.

⁸ Refer to the TU5200 documentation to set up a LAN connection at the laboratory instrument.

1. Collect a grab sample. Refer to [Collect a grab sample](#) on page 21.
2. If the SC controller and laboratory instrument do not have a LAN connection, install the SD card in the SC controller. Refer to the SC controller documentation to install the SD card.
3. At the SC controller, make a Link2SC job file as follows:
 - a. Push **menu**.
 - b. Select **LINK2SC>CREATE A NEW JOB>TU5x00 sc**.
The SC controller makes a Link2SC job file. The turbidity reading, operator ID (if available), location of the process instrument and the date and time are recorded to the job file.
In addition, the temperature, calibration settings, bubble reject setting, vial clarity and desiccant cartridge life are recorded to the Link2SC job file.
4. Push **OK**, then **YES**.
5. Select **JOB>LAB**.
The Link2SC job file is saved to the SD card (if available) or sent to the laboratory instrument (when the SC controller and laboratory instrument have a LAN connection).
To see the Link2SC job files on the SD card, select **JOBS FROM CARD**.
6. If the SC controller and laboratory instrument do not have a LAN connection, complete the steps that follow.
 - a. Remove the SD card from the SC controller.
 - b. At the laboratory instrument, put the SD card in the USB adapter. Then put the USB adapter in a USB port type A on the laboratory instrument.
7. Move the grab sample bottle to the laboratory instrument.
8. On the TU5200, push **Options>Reading Setup**.
9. Push **Bubble Reject**, then set bubble reject to on.
10. If the grab sample is 1 NTU or less, push **Reading>Minimum Mode**, then select 60 seconds.
Note: In minimum mode, readings are done continuously for 60 seconds when a measurement is done. The smallest reading within 60 seconds is saved to the data log.
11. At the laboratory instrument, push the **LINK2SC** to show the job list.
12. Select the latest Link2SC job file.
The turbidity measurement from the process instrument shows on the right side of the display.
13. Prepare a grab sample vial. Refer to [Prepare a sample vial](#) on page 19.
14. Measure the turbidity of the grab sample with the laboratory instrument. Refer to the TU5200 documentation.
If the difference between the process and laboratory measurements is not more than the selected acceptance range, "Measurement values match." shows on the display. Refer to [Configure the Link2SC settings](#) on page 24 to select the acceptance range.
If "Measurement values do not match." shows on the display, click the link to show the troubleshooting steps.
15. To show the compare log, push **Options>Compare Log**. Refer to the TU5200 documentation for more options.
16. To send the verification data to external devices that are connected to the instrument, push **Options>Send Data**. Refer to the TU5200 documentation for more options.

6.2.6.3.1 Configure the Link2SC settings

Select the acceptance range permitted when process and laboratory measurements are compared with Link2SC.

1. Push **menu**.
2. Select **SENSOR SETUP>TU5x00 sc>LINK2SC**.
3. Select an option.

Option	Description
ACCEPT. UNIT	Sets the units used to compare the process and laboratory measurements. Options: %, NTU or LAB. Select LAB when the acceptance range is supplied by the laboratory instrument.
ACCEPT. RANGE	Sets the maximum difference permitted between the process and laboratory measurements. Options: 1 to 50% (default: 10%). This option only shows when ACCEPT. UNIT is set to % or NTU.

6.3 Show the recorded data

All the recorded data is kept in the data log. The data log is divided into four logs:

- **Reading log**—Shows the recorded measurements.
- **Calibration log**—Shows the calibration history.
- **Verification log**—Shows the verification history.
- **Compare log**—Shows the recorded comparisons of process and laboratory measurements.

1. Push **Data Log** and select the applicable log to show.
2. To show the details of a log entry, select the log entry and then push **View Details**.
Note: To add a comment to the log entry, push the comments icon.
3. To only show the log entries recorded during a time interval or with a specific operator ID or sample ID, do the steps that follow.
 - a. Push **Filter**, then select **On**.
 - b. Select an option.

Option	Description
Time Interval	Selects the time interval.
Operator ID	Selects the operator ID.
Sample ID	Selects the sample ID. This option only shows when Reading Log or Compare Log is selected.

4. To send log data to a device (e.g., printer or USB flash drive), delete a log entry or show a compare log or reading log entries in a graph, do the steps that follow.
 - a. Push **Options**.

- b. Select an option.

Option	Description
Delete	Removes one of the items that follow. <ul style="list-style-type: none"> • The selected log entry • The log entries for a time interval • The log entries with a specific operator ID • The log entries with a specific sample ID⁹ • All the entries in the selected log
Send Data	Sends one of the items that follow to all the devices that are directly connected to the instrument (e.g., printer or USB flash drive) and connected to the instrument by LAN (network printer or FTP server). <ul style="list-style-type: none"> • The selected log entry • The log entries for a time interval • The log entries with a specific operator ID • The log entries with a specific sample ID⁹ • All the entries in the selected log
View Graph	Shows the reading log entries that have the same sample ID in a graph. This option only shows when Compare Log or Reading Log is selected. <p>To add the log entries for another sample ID to the graph, push Options>Add Data. Select a sample ID to add to the graph.</p> <p>To show the details of a data point, touch a data point on the display or push the LEFT and RIGHT arrows to select a data point.</p> <p>Data points—Selects the symbol used for the data points. Control Limit—Sets the minimum value and maximum value of the readings that show on the graph.</p>

6.4 Show the instrument information

1. Push **Diagnostics**.
2. Select an option.

Option	Description
Instrument Information	Shows the instrument model, version, serial number, location name and MAC address.
Signals	Shows the status of the lid, sample vial, turbidity, condensation and fouling. If a USB flash drive or PC is connected to the instrument, push the icon to send data to the USB flash drive or PC as necessary.
Instrument Backup	Store —Saves a backup of all the instrument settings and log files to a USB flash drive. Restore —Copies the instrument settings, reading log files and compare log files from a USB flash drive to the instrument. Overwrites all the instrument settings.
Instrument Update	Installs an instrument update on the instrument. Put a USB flash drive with the instrument update in a USB port.
Service Time	Shows the date entered for the last service date and for the next service date. When set to on, a service reminder shows on the display when service is due.
Factory Service	For factory use only.

⁹ This option only shows when Reading Log or Compare Log is selected.

Section 7 Calibration

▲ WARNING



Chemical exposure hazard. Obey laboratory safety procedures and wear all of the personal protective equipment appropriate to the chemicals that are handled. Refer to the current safety data sheets (MSDS/SDS) for safety protocols.

When the instrument is used for US EPA regulatory reporting, calibrations must be done according to US EPA guidance documents and methodologies. Contact local regulating authorities for additional compliance regulations.

The instrument is factory calibrated and the laser light source is stable. The manufacturer recommends that a calibration verification be done periodically to make sure that the system operates as intended. The manufacturer recommends calibration after repairs or comprehensive maintenance work.

7.1 Configure the calibration settings

Select the calibration curve, calibration interval and more.

1. Push **Calibration**.
2. Push **Options>Calibration Setup**.
3. Select an option.

Option	Description
Calibration Curve	Selects the type of standard and the calibration curve (range). StablCal RapidCal (0–40 NTU) —1-point calibration (20 NTU) with StablCal. StablCal (0–700 NTU) —2-point calibration (20 NTU and 600 NTU) with StablCal. Formazin RapidCal (0–40 NTU) —2-point calibration (20 NTU and dilution water) with Formazin. Formazin (0–700 NTU) —3-point calibration (20 NTU, 600 NTU and dilution water) with Formazin. Degrees (0–100 mg/L) —3-point calibration (20 mg/L, 100 mg/L and dilution water) with kaolin. SDVB (0–700 NTU) —3-point calibration (20 NTU, 600 NTU and dilution water) with spherical styrene divinylbenzene. Custom Calibration —1- to 6-point calibration (0.02 to 700 NTU) with StablCal or Formazin. The user selects the number of calibration points and the value of each calibration point.
Verify after Cal.	Sets the instrument to start a verification immediately after the instrument is calibrated. When set to on, the verification standard is measured immediately after a calibration is done.
Calibration Reminder	Sets the time interval between calibrations. When a calibration is due, the display will show a reminder and a question mark on the calibration icon at the top of the display. Options: Off (default), 1 day, 7 days, 30 days or 90 days. When a calibration is done, the calibration time is set to zero.
Reset to Factory Calibration	Sets the calibration settings to the factory defaults.

7.2 Calibrate the instrument

When the instrument is used for US EPA regulatory reporting, calibrations must be done according to US EPA guidance documents and methodologies. Contact local regulating authorities for additional compliance regulations.

The instrument is factory calibrated.

1. Log in to the instrument as follows:
 - Put an operator RFID tag in front of the RFID module or
 - Push **Login**. Select the applicable operator ID, then push **Select**.
2. For RFID vials, put the vial in front of the RFID module. Refer to [Figure 5](#).

A calibration is started. The instrument receives the value, the lot number, the expiration date and the Certificate of Analysis information from the RFID vial.

3. For non-RFID vials, push **Calibration**.
4. Clean the vial with a no-lint cloth to remove contamination.
Keep contamination off the glass. Refer to [Prevent vial contamination](#) on page 18.
5. Dry the external surfaces of the vial with a no-lint cloth. Make sure to dry the bottom of the vial.
6. Carefully invert at least three times. Refer to [Figure 6](#).
Note: For StablCal vials, refer to the documentation supplied with the StablCal vial to prepare the vials for use.
7. Put the vial in the vial compartment.
8. Push **Start**.
9. Confirm the value shown or enter the exact turbidity value of the standard. Push **Read**.
10. When the measurement is complete, remove the vial.
11. Do steps 2 to 10 again until all the standard values that show on the display are measured.
12. Push **Store** to complete the calibration and record the results to the calibration log.
13. To show the calibration log, push **Options>Calibration Log**. Refer to [Show the recorded data](#) on page 24 for more options.
14. To send the calibration data to external devices that are connected to the instrument, push **Options> Send Data**. Refer to [Show the recorded data](#) on page 24 for more options.

Figure 5 Put the RFID vial in front of the RFID module

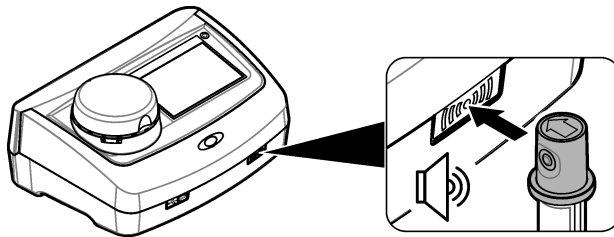
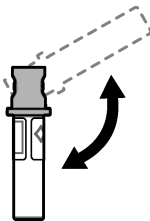

Figure 6 Invert the vial



Section 8 Verification

8.1 Configure the verification settings

Select the acceptance range and measurement units for calibration verification and more.

1. Push **Verification**.
2. Push **Options>Verification Setup**.
3. Select an option.

Option	Description
Standard Value	Measures the verification standard. The results are recorded to the instrument. For the best results, measure the verification standard immediately after calibration.
Verify after Cal.	Sets the instrument to start a verification immediately after the instrument is calibrated. When set to on, the verification standard is measured immediately after a calibration is done.
Acceptance Range	Sets the maximum difference permitted between the recorded value of the verification standard and the measured value of the verification standard during verification. Unit —Sets the acceptance range for verification to a percentage (1 to 99%) or an NTU value (0.015 to 100.00 NTU). Options: % or NTU (or mNTU).
Verification Reminder	Sets the time interval between calibration verifications. The display will show a reminder when a verification is due. Options: OFF(default), 1 day, 7 days, 30 days or 90 days. When a verification is done, the verification time is set to zero.

8.2 Do a calibration verification

Do a calibration verification to make sure that the instrument is still calibrated as necessary.

1. Log in to the instrument as follows:
 - Put an operator RFID tag in front of the RFID module or
 - Push **Login**. Select the applicable operator ID, then push **Select**.
2. Push **Verification**.
3. Clean the verification standard vial with a no-lint cloth to remove contamination. Keep contamination off the glass. Refer to [Prevent vial contamination](#) on page 18.
4. Dry the external surfaces of the vial with a no-lint cloth. Make sure to dry the bottom of the vial.
5. Carefully invert the vial three times. Refer to [Figure 6](#) on page 27.
6. Put the vial in the vial compartment.
7. Push **Start**.
8. Confirm the value shown or enter the exact turbidity value of the standard. Push **Read**.
9. When the measurement is complete, remove the vial.
The verification is recorded to the verification log.
10. To show the verification log, push **Options>Verification Log**. Refer to [Show the recorded data](#) on page 24 for more options.
11. To send the verification data to external devices that are connected to the instrument, push **Options>Send Data**. Refer to [Show the recorded data](#) on page 24 for more options.

Section 9 Maintenance

▲ CAUTION	
	Multiple hazards. Only qualified personnel must conduct the tasks described in this section of the document.

▲ CAUTION



Chemical exposure hazard. Obey laboratory safety procedures and wear all of the personal protective equipment appropriate to the chemicals that are handled. Refer to the current safety data sheets (MSDS/SDS) for safety protocols.

▲ CAUTION



Personal injury hazard. Never remove covers from the instrument. This is a laser-based instrument and the user risks injury if exposed to the laser.

NOTICE

Do not disassemble the instrument for maintenance. If the internal components must be cleaned or repaired, contact the manufacturer.

9.1 Clean spills

▲ CAUTION



Chemical exposure hazard. Dispose of chemicals and wastes in accordance with local, regional and national regulations.

1. Obey all facility safety protocols for spill control.
2. Discard the waste according to applicable regulations.

9.2 Clean the instrument

Clean the exterior of the instrument with a moist cloth, and then wipe the instrument dry.

9.3 Clean a sample vial

▲ CAUTION



Chemical exposure hazard. Obey laboratory safety procedures and wear all of the personal protective equipment appropriate to the chemicals that are handled. Refer to the current safety data sheets (MSDS/SDS) for safety protocols.

Clean the sample vial when there is contamination in the sample vial after the sample vial is rinsed.

Items to collect:

- Hydrochloric acid (concentration 10%)
 - Laboratory cleaning detergent for glass (concentration 0.1%)
 - Distilled or deionized water
 - Dilution water
 - Vial wiper (optional)
 - No-lint cloth
1. Put the exterior and interior surfaces of the sample vial and the cap in 10% hydrochloric acid for 15 minutes.
 2. Clean the exterior and interior surfaces of the sample vial and the cap with laboratory cleaning detergent for glass (concentration 0.1%).
 3. Fully rinse the sample vial three times with distilled or deionized water.
Note: If the sample vial is used to measure low range turbidity samples or dilution water, rinse with dilution water (not distilled or deionized water).
 4. For the best results, clean the sample vial with the optional vial wiper. Then fully rinse the sample vial again. Refer to [Figure 7](#).

5. Dry the external surfaces of the sample cell with a soft, no-lint cloth. Do not let the sample vial air dry.
6. For storage, fill the sample vial with distilled or demineralized water.
Note: If the sample vial is used to measure low range turbidity samples or dilution water, fill the sample vial with dilution water (not distilled or deionized water).
7. Immediately put the cap on the sample vial to keep the interior of the sample vial wet.

Figure 7 Clean the vial with the vial wiper (optional)

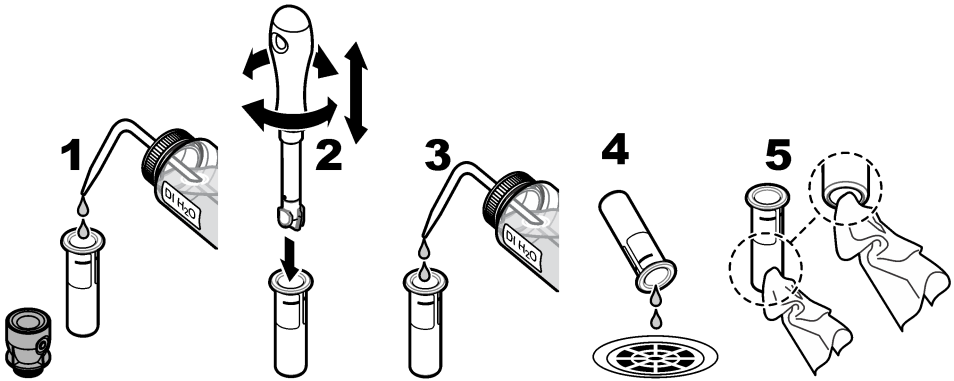

9.4 Clean the vial compartment

Clean the vial compartment only when the compartment has contamination. Make sure that the tool to clean the vial compartment has a soft surface and does not damage the instrument. [Table 3](#) shows the options on how to clean the vial compartment.

Table 3 Cleaning options

Contaminant	Options
Dust	Vial compartment wiper, micro fiber cloth, lint-free cloth
Liquid, oil	Cloth, water and cleaning agent

Section 10 Troubleshooting

Message	Solution
Startup	
The self-check stopped. Clean the vial compartment.	The vial compartment is dirty. Set the power to off. Clean the vial compartment. Refer to Clean the vial compartment on page 30. Set the power to on. If the self check is not successful, contact technical support.
The self-check stopped. Close the lid.	Close the lid. Push Close .
The self-check stopped. Hardware error. Error [x]	Set the power to off, wait 20 seconds and then set the power to on again. If the self check is not successful, record the error number and contact technical support.
The self-check stopped. The light source is not stable.	Contact technical support.

Message	Solution
The last update was not completed. Update the instrument.	Connect the USB flash drive to the instrument to install the instrument update files. Complete the steps that show on the display.
Next calibration is due!	Calibrate the instrument. Refer to Calibrate the instrument on page 26. Note: The calibration reminder is set to on. Refer to Configure the calibration settings on page 26.
Next service is due!	Contact technical support. Note: The service reminder is set to on. Refer to Show the instrument information on page 25.
Next verification is due!	Do a calibration verification. Refer to Do a calibration verification on page 28. Note: The verification reminder is set to on. Refer to Configure the verification settings on page 28.
Reading	
Clean the vial.	Wipe the sample vial with a no-lint cloth to remove contamination and condensation from the glass.
Hardware error / instrument error	Set the power to off, wait 20 seconds and then set the power to on again. If the problem continues, contact technical support.
The calibration range is exceeded.	The measured turbidity is more than the calibration range of the instrument. Select a calibration curve for the full measurement range. Refer to Configure the calibration settings on page 26.
The measurement range is exceeded.	The measured turbidity is more than the measurement range of the instrument.
Calibration/Verification	
Instrument error	Examine the standards. Start the calibration or verification again. If calibration (or verification) is not successful, contact technical support.
The standard is not stable.	Use the correct calibration standards. Invert the standard until no bubbles or large particles show.
The standard value is out of the measurement range.	Use the correct calibration standards. Invert the standards. Make sure to measure the standards in ascending order.
The standard value is too low.	The wrong calibration standard is in the vial compartment. Make sure that the standard has not expired. Put the correct calibration standard in the vial compartment. Make sure to invert the standard.
The standard value is too high.	The wrong calibration standard is in the vial compartment. Make sure that the standard has not expired. Put the correct calibration standard in the vial compartment.
Verification failed.	Examine the verification standard. Calibrate the instrument. Refer to Calibrate the instrument on page 26. If verification is not successful, push Calibration>Options>Calibration Setup>Reset to Factory Calibration>OK .

Message	Solution
Compare process and laboratory measurements	
Measurement values are not the same.	<p>Click the link to get troubleshooting information. Some typical solutions are as follows:</p> <ul style="list-style-type: none"> • Clean the vial. Refer to Clean a sample vial on page 29. • Calibrate the instrument with the same calibration curve as the process instrument. Use the same standards to calibrate the process and laboratory instruments. Make sure that the standards have not expired. • Set the Bubble Reject setting to on. Refer to Configure the measurement settings on page 15. • There was too much time between the process measurement and laboratory measurement. • Clean the vial compartment.
Instrument update	
Copy from USB Memory failed	<p>Remove large files from the USB flash drive that use too much space. Start the instrument update procedure again.</p> <p>Remove the instrument update files from the USB flash drive. Save the instrument update files again to the USB flash drive.</p> <p>Connect the USB flash drive to the instrument. Start the instrument update procedure again.</p>
Instrument update file is missing	<p>Remove the instrument update files from the USB flash drive. Save the instrument update files again to the USB flash drive.</p> <p>Connect the USB flash drive to the instrument. Start the instrument update procedure again.</p>
Instrument update file is corrupt	
Update script file is corrupt	
Not enough memory to update the instrument	Contact technical support.
USB memory is not connected.	<p>Connect a USB flash drive to the instrument. Make sure that the file system "FAT32" is installed on the USB flash drive.</p> <p>Set the power to off, wait 20 seconds and then set the power to on again. Connect the USB flash drive. Start the instrument update procedure again.</p>
Read/Write to USB flash drive	
Cannot write to USB memory	<p>Connect a USB flash drive to the instrument. Make sure that the file system "FAT32" is installed on the USB flash drive.</p>
Cannot read from USB memory	<p>Set the power to off, wait 20 seconds and then set the power to on again. Look for remaining space on the USB flash drive.</p> <p>Set the power to off, wait 20 seconds and then set the power to on again. Connect the USB flash drive to the instrument.</p>
Restore backup	
No instrument backup is available.	<p>Connect a USB flash drive to the instrument. Make sure that the file system "FAT32" is installed on the USB flash drive.</p>
Not able to restore the backup	<p>Set the power to off, wait 20 seconds and then set the power to on again. Connect the USB flash drive. Start the instrument update procedure again.</p>
Security	
Invalid password	Enter the correct password. If the password is lost, contact technical support.
Send data	
Connect a receiving device.	Examine the device connections. Set the Auto Send setting to off. Refer to Configure the measurement settings on page 15.

Message	Solution
Add sample IDs from list	
No valid data found	No sample ID file was found on the USB flash drive.
Not able to read sampling date.	Make sure that the date and time format is dd.mm.yyyy hh:mm.
The instrument cannot read the Sample ID	Examine the text strings. Refer to Import sample IDs (optional) on page 14.
Problem/Error: Incorrect date Possible cause: The wrong date format.	Make sure that the date and time format is dd.mm.yyyy hh:mm.
The sample ID list full. Data has not been added	Remove the sample IDs that are not used. Add a new sample ID.
Documents/Videos	
The document does not show on the display.	Make sure that the document is saved as a PDF.
Not enough memory to store the document.	Delete other documents, then add the document again.
Cannot delete the document.	Contact technical support.
Cannot store the document.	Contact technical support.
Cannot open the manual.	Make sure that the document format is PDF.
The video format is not supported.	Make sure that the video format is AVI (Codec XVID) with a resolution of 640 x 480 pixels. Make sure that the video size is not more than 10 Mb.
The video does not play.	The video file is corrupt.
Ethernet/LAN connection	
Network authentication failed	Enter the correct username and password. Make sure that the network settings are correctly configured.
LAN Connection failed	
Automatic retrieval of the local IP address failed!	There is no connection to the DHCP server. Contact the network administrator. If the DHCP server is not enabled, manually enter an IP address for the instrument.
Setting IP-address failed!	Contact the network administrator. If necessary, contact technical support.
Setting subnet-mask failed!	
Setting default gateway failed!	
Mounting network drive failed!	
FTP connection failed!	
Verify network configuration	
Files did not save to the network share.	Make sure that the correct permissions are set to the network share directory.
No connection to the web server.	Try to connect the instrument to a LAN again later. Make sure that the instrument is connected to the network.

Message	Solution
RFID	
Standard expired. Continue?	Use standards that are not expired.
Primary standard is write protected.	The verification standard value cannot be recorded on a calibration standard.
Measured value is out of nominal value range.	The measured value is not within range for this standard. The 10 NTU standard range is 5 to 15 NTU. The < 0.1 NTU glass verification rod range is 0 to 0.1 NTU. Use the correct standard. Make sure that the standard is not expired. Measure the standard again.
No act. value on RFID tag. Read standard?	Measure the verification standard first on an instrument that was recently calibrated.
Measured with different calibration. Read standard?	The verification standard was measured for a different calibration curve (e.g., StabiCal, Formazin, SDVB, degrees or custom).
Measured with different instrument type. Read standard?	The verification standard was measured on a different type of instrument (e.g., different lasers).

10.1 Remove air bubbles from the sample

Air bubbles can cause unstable readings. Use a degassing method to remove air or other gases from the sample before measurement even if no bubbles are seen.

The methods typically used for degassing are:

- Let the sample stand for several minutes
- Apply a vacuum
- Use the sample degassing kit
- Use an ultrasonic bath

Let the samples stand for several minutes, then gently invert two or three times before measurement.

In some cases, more than one method may be necessary to remove bubbles (e.g., the use of heat with an ultrasonic bath may be necessary in some severe conditions). Use care with these methods as sample turbidity can be changed if these methods are not used correctly.

10.2 Condensation

If condensation collects on the sample vial during measurement, let the sample become slightly warmer before measurement. Keep the sample at room temperature or partially put the sample vial into a warm water bath for a short time.

Note: A temperature increase can change the sample turbidity. Measure the sample before the temperature increases when possible.

Section 11 Replacement parts and accessories

▲ WARNING



Personal injury hazard. Use of non-approved parts may cause personal injury, damage to the instrument or equipment malfunction. The replacement parts in this section are approved by the manufacturer.

Note: Product and Article numbers may vary for some selling regions. Contact the appropriate distributor or refer to the company website for contact information.

Recommended standards

Description	Quantity	Item no.
Verification standard, < 0.1 NTU, glass verification rod (solid secondary standard)	each	LZY901
StabiCal kit, sealed vials with RFID, includes: 10, 20 and 600 NTU vials	each	LZY835
StabiCal 20-NTU sealed vial with RFID	each	LZY837
StabiCal 600-NTU sealed vial with RFID	each	LZY838
StabiCal kit, sealed vials without RFID, includes: 10, 20 and 600 NTU vials	each	LZY898
StabiCal 20-NTU sealed vial without RFID	each	LZY899
StabiCal 600-NTU sealed vial without RFID	each	LZY900

Replacement parts

Description	Quantity	Item no.
Cover, USB port type A	1	LZV881
Dust cover	1	LZV947
Lid	1	LZV968
Power supply, 100 to 240 V, 50/60 Hz	1	LZV844
Sample vials with caps	2	LZV946
Vial stand	1	LZV952

Accessories

Description	Quantity	Item no.
Micro fiber cloth, vial cleaning	1	LZY945
RFID tags, operator	2/pkg	LZQ066
RFID stickers, sample bottle, black ¹⁰	3/pkg	LZQ067
Vial wiper	1	LZY903
Vial compartment wiper	1	LZY910
Sample degassing kit	1	4397510

¹⁰ Other colors are available.



HACH COMPANY World Headquarters

P.O. Box 389, Loveland, CO 80539-0389 U.S.A.
Tel. (970) 669-3050
(800) 227-4224 (U.S.A. only)
Fax (970) 669-2932
orders@hach.com
www.hach.com

HACH LANGE GMBH

Willstätterstraße 11
D-40549 Düsseldorf, Germany
Tel. +49 (0) 2 11 52 88-320
Fax +49 (0) 2 11 52 88-210
info-de@hach.com
www.de.hach.com

HACH LANGE Sàrl

6, route de Compois
1222 Vézenaz
SWITZERLAND
Tel. +41 22 594 6400
Fax +41 22 594 6499