



DOC023.52.90653

BioTector B7000 Online TOC TN Analyzer

Installation and Operation

12/2025, Edition 5

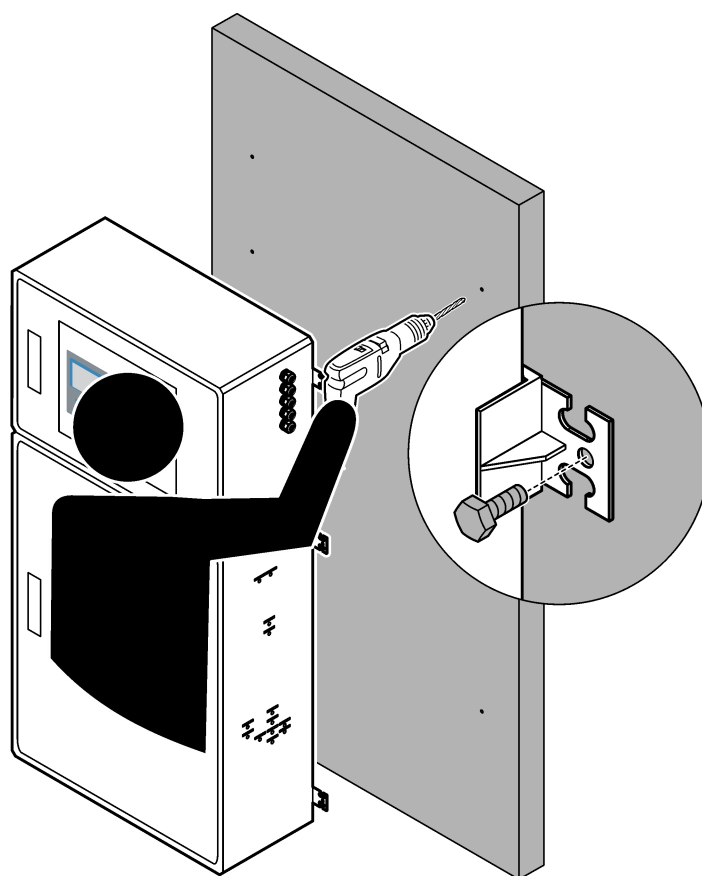

Section 1 Specifications	3
Section 2 General information	7
2.1 Safety information.....	7
2.1.1 Safety symbols and markings.....	7
2.1.2 Use of hazard information.....	8
2.1.3 Ozone precautions.....	8
2.1.4 Zeolite precautions.....	9
2.2 EMC compliance.....	9
2.3 Compliance and certification marks.....	10
2.4 EMC compliance statement (Korea).....	10
2.5 Product overview.....	11
2.6 Product components.....	12
Section 3 Installation and startup checklist	13
Section 4 Installation	17
4.1 Installation guidelines.....	17
4.2 Wall mount.....	17
4.3 Electrical installation.....	19
4.3.1 Electrostatic discharge (ESD) considerations.....	19
4.3.2 Open the doors.....	19
4.3.3 Connect power.....	20
4.3.4 Connect the relays.....	20
4.3.5 Connect the analog outputs.....	21
4.3.6 Power, analog output and relay terminals.....	22
4.3.7 Optional digital inputs, modules and relays.....	23
4.3.8 Connect Modbus RTU (RS485).....	24
4.3.9 Connect Modbus TCP/IP (Ethernet).....	27
4.3.9.1 Configure the Modbus TCP/IP module.....	27
4.3.9.2 Connect the Modbus TCP/IP module.....	27
4.4 Plumbing.....	29
4.4.1 Tube connections.....	29
4.4.2 Plumb the sample stream(s) and manual stream(s).....	30
4.4.3 Sample line guidelines.....	30
4.4.4 Install a sample overflow chamber (optional).....	33
4.4.5 Plumb the drain lines.....	33
4.4.6 Connect oxygen.....	35
4.4.7 Plumb the exhaust.....	36
4.4.8 Plumb the reagents.....	36
4.4.8.1 Use a stainless steel fitting for the base reagent (optional).....	39
4.4.9 Install the pump tubing.....	40
4.4.10 Install the pump tube rails.....	40
4.4.11 Connect the internal tubing.....	41
4.4.12 Connect the air purge.....	41
Section 5 Startup	43
5.1 Set the language.....	43
5.2 Set the time and date.....	43
5.3 Adjust the display brightness.....	43
5.4 Examine the oxygen supply.....	43
5.5 Examine the pumps.....	44
5.6 Examine the valves.....	45
5.7 Set the reagent volumes.....	45

Table of Contents

5.8 Analysis enclosure	46
Section 6 Configuration	49
6.1 Set the measurement interval	49
6.2 Set the sample pump times	49
6.2.1 Do a sample pump test	49
6.3 Set the stream sequence and operation range	50
6.4 Configure the COD and BOD settings	51
6.5 Configure the install new reagents settings	52
6.6 Set reagent monitoring	52
6.7 Configure the analog outputs	53
6.8 Configure the relays	55
6.9 Configure the communication settings	58
6.10 Configure the Modbus TCP/IP settings	58
6.11 Save the settings to memory	59
6.12 Set security passwords for menus	59
6.13 Show the software version and serial number	60
Section 7 Calibration	61
7.1 Start a zero calibration or zero check	61
7.1.1 Measure deionized water	62
7.2 Start a span calibration or span check	63
7.3 Plumb the calibration standard	64
7.4 Prepare the calibration standard	64
Section 8 User interface and navigation	67
8.1 Keypad description	67
8.2 Reaction Data screen	67
8.3 Status messages	68
8.4 Reaction Graph screen	69
Section 9 Operation	71
9.1 Start or stop measurements	71
9.2 Measure a grab sample	71
9.3 Save data to an MMC/SD card	72

Section 1 Specifications

Specifications are subject to change without notice.

This product does not comply with, and is not intended to be put into, regulated bodies of water or fluid, which includes drinking water or food contact materials in food and beverage.

Table 1 General specification

Specification	Details
Dimensions (H x W x D)	1250 to 1500 x 750 x 320 mm (49.2 to 59.1 x 29.5 x 12.6 in.), depending on system optional features
Enclosure	Rating: IP44 with the doors closed and latched; optional IP54 with air purge or vortex cooler Material: Fiberglass reinforced polyester (FRP)
Weight	90 to 120 kg (198.5 to 264.5 lb)
Mounting	Wall mount, indoor installation
Protection class	Class 1 (PE connected)
Pollution degree	2
Installation category	II
Electrical requirements	110–120 VAC, 50/60 Hz, 300 W (2.6 A), or 200–230 VAC, 50/60 Hz, 300 W (1.3 A) Refer to the product rating label for the electrical requirements. Use a permanent field wiring connection.
Cable entry	Typically, five cable glands (strain relief fittings) are supplied with the analyzer. PG13.5 cable glands have a clamping range of 6-12 mm. PG11 cable glands have a clamping range of 5-10 mm.
Mains power wire	2 Core +PE ¹ +Screened; 1.5 mm ² (16 AWG) rated 300 VAC, 60 °C, VW-1; The cable type is to be SJT, SVT, SOOW or <HAR> equivalent cable, depending on the application. The power cable installed in accordance with local and regional codes, suitable for end application. Connected to a dedicated and isolated branch circuit protected supply rated 10 A.
Signal wire	4 wires (twisted pair, shielded cable) and more 2 wires for each additional signal, 0.22 mm ² (24 AWG) minimum and rated 1 A; depending on the configuration and options installed on the analyzer
Modbus RTU wire	2 wires (twisted pair, shielded cable), 0.22 mm ² (24 AWG) minimum UL AWM Style 2919 or equivalent for application
Fuses	Refer to the fuse location diagram on the top door. In addition, refer to the Maintenance and Troubleshooting manual for the specifications.
Operating temperature	5 to 40 °C (41 to 104 °F) Note: Cooling options are available for the analyzer.
Operating humidity	5 to 85% non-condensing relative humidity
Storage temperature	-20 to 60 °C (-4 to 140 °F)
Altitude	2000 m (6562 ft) maximum
Display	High contrast, 40 character x 16 line backlit LCD with LED backlight
Sound	< 60 dBa
Sample streams	Six sample streams maximum. Refer to Table 2 for sample requirements.
Data storage	5800 measurements and 99 error entries in analyzer memory

¹ Protective earth

Specifications

Table 1 General specification (continued)

Specification	Details
Data send	MMC/SD card to save data, software updates and configuration updates
Analog outputs	One 4–20 mA output signal (six maximum), user configurable (direct or multiplex mode), optically isolated, self powered, 500 Ω impedance maximum
Relays	Two configurable relays; one non-configurable relay for system faults; volt free contacts, 1 A at 30 VDC maximum Note: Add a maximum of four optional relays to supply six configurable relays to the analyzer.
Communications (optional)	Modbus RTU, Modbus TCP/IP or Profibus. The software requirement for Modbus RTU and TCP/IP is version 2.13 or later. Note: When the Profibus option is selected, the analyzer sends the digital output signals through the Profibus converter with the specific communication protocol of Profibus.
Remote control (optional)	Digital inputs for remote standby, remote stream selection, operation range selection and remote grab sample measurement In addition, the analyzer can be controlled remotely with Modbus.
Reagents	0.5 N HCl and 1000-mgC/L sodium oxalate (NaOx) mixture 1.2 N sodium hydroxide (NaOH) 1.8 N sulfuric acid (H ₂ SO ₄) that contains 40-mg/L manganese sulfate monohydrate For the reagent usage rate, refer to Table 11 on page 38.
Oxygen purity	Oxygen with no carbon dioxide, carbon monoxide, nitrogen, hydrocarbons or water (93% oxygen minimum and the remaining gas is argon)
Oxygen pressure	Oxygen concentrator plumbed to filtered instrument air—200 L/h at less than 0.6 bar (8.7 psi). Instrument air pressure: 2.1 bar (30.5 psi, 90 L/minute) Oxygen concentrator with integrated air compressor—200 L/h at less than 0.6 bar (8.7 psi) Oxygen cylinder, 50 L (welding grade)—1.0 bar (14.5 psi)
Calibration standard	Zero calibration: Deionized water Span calibration: TIC (total inorganic carbon), TOC (total organic carbon) and TN (total nitrogen) concentration in the calibration standard is based on the operation range selected for span calibrations.
Certifications	CE, cETLus Optional: Class 1 Division 2 and ATEX Zone 2 hazardous area certifications
Warranty	1 year

Table 2 Sample requirements

Specification	Details
Sample types	Samples can contain fats, greases, oils and 30% chlorides (salts) maximum. Calcium 1000 ppm maximum. Refer to Table 5 and Table 6 for sodium chloride interference.
Sample particle size	2 mm diameter maximum, soft particulates Note: Hard particulates (e.g., sand) will cause damage to the analyzer.
Sample pressure	Ambient at sample and manual (grab sample) inlets Note: For pressurized sample streams, use the optional Sample Overflow Chamber to supply sample at ambient pressure to the analyzer.
Sample temperature	2 to 60 °C (36 to 140 °F)
Sample flow rate	100 mL minimum for each sample stream

Table 3 Performance specifications

Specification	Details
Range ²	0 to 10 mg/L, 0 to 20000 mg/L
Cycle time	7 minutes to measure TIC, TOC and TN (minimum) <i>Note: The cycle time is based on the operation range and application.</i>
Exceedance tracking	Full exceedance tracking to maximum operation range
Range selection	Automatic or manual selection of the operation range
Repeatability ³	TOC: ±3% of reading or ±0.3 mg/L (the larger value) with automatic range selection TN: ±3% of reading or ±0.2 mg/L (the larger value) with automatic range selection
Signal drift (1 year)	< 5%
Detection limit ³	TOC: 0.6 mg/L with automatic range selection TN: 0.4 mg/L with automatic range selection

Table 4 Analysis specifications

Specification	Details
Oxidation method	Two-stage advanced oxidation process (TSAO) with hydroxyl radicals
TOC measurement	NDIR (non-dispersive infrared sensor) measurement of CO ₂ after oxidation
TN measurement	Direct photometric analysis of nitrate after oxidation
VOC	Calculated with algorithm that includes TOC measurement results
COD and BOD	Calculated with correlation algorithm that includes TOC and/or TN measurement results

Table 5 Sodium chloride interference—TOC

Parameter	Interference level
TOC	None

Table 6 Sodium chloride interference—TN

2-mm cell		0.5-mm cell	
TN Range	Interference level	TN Range	Interference level
0–19	None below 1.4% w/v	2–55	None below 3.6% w/v
0–21	None below 1.6% w/v	2–61	None below 4.1% w/v
0–30	None below 2.9% w/v	2–88	None below 7.1% w/v
0–68	None below 5.3% w/v	5–200	None below 13% w/v
0–115	None below 9.3% w/v	8–350	None below 23% w/v
0–200	None below 16% w/v	16–600	None below 30% w/v
0–1200	None below 30% w/v	80–3650	None below 30% w/v
0–5000	None below 30% w/v	160–15000	None below 30% w/v

w/v is the weight of solute in grams and the volume of solution in mL.

² There are three operation ranges for each parameter (e.g., TOC) and each sample stream (e.g., STREAM 1).

³ TOC range of 0 to 50 ppm or 0 to 100 ppm and with 2 mm TN cell

Section 2 General information

In no event will the manufacturer be liable for direct, indirect, special, incidental or consequential damages resulting from any defect or omission in this manual unless otherwise required by applicable law or contract between the parties. The manufacturer reserves the right to make changes in this manual and the products it describes at any time, without notice or obligation. Revised editions are found on the manufacturer's website.

2.1 Safety information

The manufacturer is not responsible for any damages due to misapplication or misuse of this product including, without limitation, direct, incidental and consequential damages, and disclaims such damages to the full extent permitted under applicable law. The user is solely responsible to identify critical application risks and install appropriate mechanisms to protect processes during a possible equipment malfunction.









Please read this entire manual before unpacking, setting up or operating this equipment. Pay attention to all danger and caution statements. Failure to do so could result in serious injury to the operator or damage to the equipment.

If the equipment is used in a manner that is not specified by the manufacturer, the protection provided by the equipment may be impaired. Do not use or install this equipment in any manner other than that specified in this manual.







2.1.1 Safety symbols and markings

Read all labels and tags attached to the instrument. Personal injury or damage to the instrument could occur if not observed. A symbol on the instrument is referenced in the manual with a precautionary statement.

The safety symbols and marking that follow are used on the equipment and in the product documentation. The definitions are in the table that follows.

	Caution/Warning. This symbol identifies that an appropriate safety instruction should be followed or a potential hazard exists.
	Hazardous voltage. This symbol indicates that hazardous voltages are present where a risk of electrical shock exists.
	Hot surface. This symbol indicates that the marked item can be hot and should not be touched without care.
	Corrosive substance. This symbol identifies the presence of a strong corrosive or other hazardous substance and a risk of chemical harm. Only individuals qualified and trained to work with chemicals should handle chemicals or perform maintenance on chemical delivery systems associated with the equipment.
	Toxic. This symbol indicates a toxic/poisonous substance hazard.
	This symbol indicates the presence of devices sensitive to Electro-static Discharge (ESD) and indicates that care must be taken to prevent damage with the equipment.
	This symbol indicates a flying debris hazard.
	Protective earth. This symbol indicates a terminal which is intended for connection to an external conductor for protection against electric shock in case of a fault (or the terminal of a protective earth (ground) electrode).

General information

	Noiseless (clean) earth. This symbol indicates a functional earthing (grounding) terminal (e.g., a specially designed earthing (grounding) system) to avoid a malfunction of the equipment.
	This symbol indicates an inhalation hazard.
	This symbol indicates that respiratory personal protective equipment (PPE) is required when there is powder or dust in the enclosure.
	This symbol indicates there is a lifting hazard because the object is heavy.
	This symbol indicates a fire hazard.
	Electrical equipment marked with this symbol may not be disposed of in European domestic or public disposal systems. Return old or end-of-life equipment to the manufacturer for disposal at no charge to the user.

2.1.2 Use of hazard information

⚠ DANGER
Indicates a potentially or imminently hazardous situation which, if not avoided, will result in death or serious injury.
⚠ WARNING
Indicates a potentially or imminently hazardous situation which, if not avoided, could result in death or serious injury.
⚠ CAUTION
Indicates a potentially hazardous situation that may result in minor or moderate injury.
NOTICE
Indicates a situation which, if not avoided, may cause damage to the instrument. Information that requires special emphasis.

2.1.3 Ozone precautions

⚠ CAUTION	
	Ozone inhalation hazard. This instrument produces ozone that is contained within the equipment, specifically within the internal plumbing. The ozone could be released under fault conditions.

It is required to plumb the exhaust gas port to a fume hood or to the building exterior in accordance with local, regional and national requirements.

Exposure to even low concentrations of ozone can damage delicate nasal, bronchial and pulmonary membrane. In sufficient concentration, ozone can cause headaches, coughing, eye, nose and throat irritation. Immediately, move the victim to uncontaminated air and seek first aid.

The type and harshness of symptoms are based on the concentration and exposure time (n). Ozone poisoning includes one or more of the symptoms that follow.

- Irritation or burning of the eyes, nose or throat
- Lassitude
- Frontal headache
- Sensation of sub-sternal pressure
- Constriction or oppression
- Acid taste in mouth
- Asthma

In case of more severe ozone poisoning, the symptoms can include dyspnea, cough, choking sensation, tachycardia, vertigo, lowering of blood pressure, cramping, chest pain, and generalized body pain. Ozone can cause a pulmonary oedema one or more hours after exposure.

2.1.4 Zeolite precautions

⚠ CAUTION	
	<p>Inhalation hazard. The molecular sieve material used in the oxygen concentrator is classified as an irritant substance. Molecular sieve material can be released in a fault condition. Exposure to dust or particles from this material may pose serious health risks, including respiratory irritation and long-term effects.</p>

Immediate or short-term effects

- Respiratory irritation: Coughing, throat irritation, and difficulty breathing are common initial symptoms due to dust exposure. Chest discomfort or pain: Some individuals report chest pain shortly after exposure.

Chronic or long-term risks

- Pulmonary fibrosis: Scarring and thickening of lung tissue, leading to chronic shortness of breath and persistent cough.

Precautions

- Always wear appropriate personal protective equipment (PPE) when handling or servicing components containing molecular sieve material.
- PPE must include chemical-resistant gloves, protective eyewear, and a NIOSH-MSHA face mask or respirator rated for fine particulate filtration. Refer to the applicable safety data sheet (SDS). Refer to maintenance and troubleshooting manual for more information on troubleshooting.

2.2 EMC compliance

⚠ CAUTION	
<p>This equipment is not intended for use in residential environments and may not provide adequate protection to radio reception in such environments.</p>	

CE (EU)

The equipment meets the essential requirements of EMC Directive 2014/30/EU.

UKCA (UK)

The equipment meets the requirements of the Electromagnetic Compatibility Regulations 2016 (S.I. 2016/1091).

Canadian Radio Interference-Causing Equipment Regulation, ICES-003, Class A:

Supporting test records reside with the manufacturer.

General information

This Class A digital apparatus meets all requirements of the Canadian Interference-Causing Equipment Regulations.

Cet appareil numérique de classe A répond à toutes les exigences de la réglementation canadienne sur les équipements provoquant des interférences.

FCC Part 15, Class "A" Limits

Supporting test records reside with the manufacturer. The device complies with Part 15 of the FCC Rules. Operation is subject to the following conditions:

1. The equipment may not cause harmful interference.
2. The equipment must accept any interference received, including interference that may cause undesired operation.

Changes or modifications to this equipment not expressly approved by the party responsible for compliance could void the user's authority to operate the equipment. This equipment has been tested and found to comply with the limits for a Class A digital device, pursuant to Part 15 of the FCC rules. These limits are designed to provide reasonable protection against harmful interference when the equipment is operated in a commercial environment. This equipment generates, uses and can radiate radio frequency energy and, if not installed and used in accordance with the instruction manual, may cause harmful interference to radio communications. Operation of this equipment in a residential area is likely to cause harmful interference, in which case the user will be required to correct the interference at their expense. The following techniques can be used to reduce interference problems:

1. Disconnect the equipment from its power source to verify that it is or is not the source of the interference.
2. If the equipment is connected to the same outlet as the device experiencing interference, connect the equipment to a different outlet.
3. Move the equipment away from the device receiving the interference.
4. Reposition the receiving antenna for the device receiving the interference.
5. Try combinations of the above.

2.3 Compliance and certification marks

	<p>The CE (European Conformity "Conformité Européene") mark on the instrument indicates that "The instrument complies with the European product directives, health, safety and environmental protection legislations".</p>
	<p>The ETL (Electrical Testing Laboratories) Listed mark on the instrument indicates that "This product has been tested to Safety Requirements of Electrical Equipment for Measurements, Control and Laboratory use; Part 1: General Requirements of ANSI/UL 61010-1 and CAN/CSA-C22.2 No 61010-1".</p> <p>The Intertek ETL listed mark on the instrument identifies that the product has been tested by Intertek, found in compliance with accepted national standards, and the instrument meets the minimal requirements required for sale or distribution.</p>

2.4 EMC compliance statement (Korea)

Type of equipment	Additional information
<p>A 급 기기 (업무용 방송통신기자재)</p>	<p>이 기기는 업무용 (A 급) 전자파적합기기로서 판매자 또는 사용자는 이 점을 주의하시기 바라며, 가정외의 지역에서 사용하는 것을 목적으로 합니다.</p>
<p>Class A equipment (Industrial Broadcasting and Communication Equipment)</p>	<p>This equipment meets Industrial (Class A) EMC requirements. This equipment is for use in industrial environments only.</p>

2.5 Product overview

NOTICE

Perchlorate Material—Special handling may apply. Refer to www.dtsc.ca.gov/perchlorate. This perchlorate warning applies only to primary batteries (provided singly or installed on this equipment) when sold or distributed in California, USA.

The B7000 TOC TN analyzer is intended for the measurement of total organic carbon and total nitrogen.

The analyzer can measure the parameters that follow in wastewater, process water, surface water and seawater:

- **TIC**—Total in-organic carbon in mgC/L
- **TOC (NPOC)**—Total organic carbon in mgC/L, includes NPOC (non-purgeable organic carbon)
- **TOC (NPOC + POC)**—Total organic carbon in mgC/L, includes NPOC and POC (purgeable organic carbon)
- **TC**—TIC + TOC
- **TN**—Total nitrogen in mgN/L (organic and inorganic nitrogen + ammonium nitrogen + nitrate nitrogen + nitrite nitrogen)
- **VOC (POC)**⁴—Volatile organic carbon, includes POC
- **COD**⁴—Chemical oxygen demand
- **BOD**⁴—Biochemical oxygen demand

The analyzer uses the analysis methods in [Table 4](#) on page 5.

For theory of operation information, refer to the BioTector B7000 videos on youtube.com and Hach Support Online (<https://support.hach.com>).

The analyzer is factory configured as one of the systems that follow:

- **TIC + TOC system**⁵—Measures the total inorganic carbon (TIC) and total organic carbon (TOC) content of a sample. The TOC result is the non-purgeable organic carbon (NPOC). The TIC + TOC system is used to measure samples that does not contain volatile organic material or contain a very small concentration of volatile organic material.
- **TC system**—Measures the total carbon (TC) content of a sample. The TC result is the sum of TIC, NPOC and purgeable organic carbon (POC) content of a sample.
- **VOC system**—Measures the TIC, TOC, TC and volatile organic carbon (VOC) contents of a sample with two analysis reactions in a single reactor configuration. The VOC result is the purgeable organic carbon (POC). The TOC result is calculated from the TC and TIC measurements as a TC – TIC result. Thus, the TOC result includes the VOC (POC) content of the sample. The TOC result is the sum of NPOC and POC content.

[Figure 1](#) shows an overview of the analyzer.

NOTICE

The accessories for the analyzer (e.g., oxygen concentrator, vacuum sampler and venturi sampler) have separate user manuals.

For installation in hazardous (classified) locations, refer to the instructions in the ATEX Category 3 Zone 2 manual and Series 4 Z-purge manual.

⁴ Calculated with a correlation algorithm that includes TOC and/or TN results. To show the calculated results on the display, set the DISPLAY setting on the COD and/or BOD PROGRAM menu to YES.

⁵ The standard analyzer is a TIC + TOC system.

NOTICE

Make sure that the door handles are fully turned before the doors are opened or damage to the door seal can occur. If the door seal has damage, dust and liquid can enter the enclosure.

Figure 1 Product overview with side view

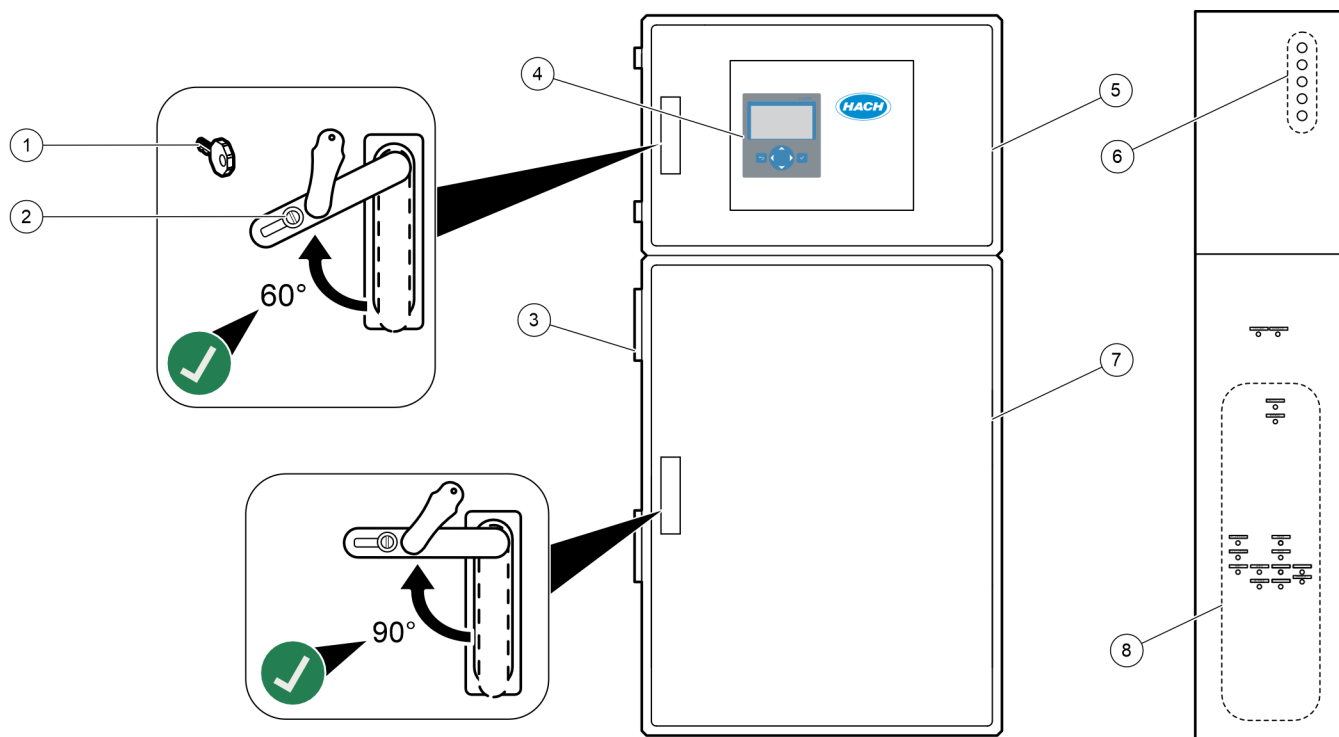

1 Door key	5 Control enclosure
2 Door lock	6 Cable strain-relief fittings for electrical connections
3 Fan	7 Analysis enclosure (refer to Analysis enclosure on page 46)
4 Display and keypad	8 Reagent, sample and drain fittings

2.6 Product components

Make sure that all components have been received. Refer to the supplied documentation. If any items are missing or damaged, contact the manufacturer or a sales representative immediately.

Section 3 Installation and startup checklist

Use the checklist that follows to complete installation and startup. Do the tasks in the order given.

Task	Initial
Wall mounting:	
Identify the correct installation location. Refer to Installation guidelines on page 17.	
Install the mounting brackets. Attach the analyzer to a wall. Refer to Wall mount on page 17.	
Electrical connections:	
Connect the analyzer to power. Refer to Connect power on page 20. The analyzer is a permanently wired device and configured for 120V or 240V as indicated on the product type label on the left side of the upper enclosure. Do not set the power to on.	
(Optional) Connect the relays to external devices. Refer to Connect the relays on page 20.	
(Optional) Connect the 4–20 mA outputs to external devices. Refer to Connect the analog outputs on page 21.	
Connect the optional digital inputs if installed. Refer to Optional digital inputs, modules and relays on page 23.	
Connect the Modbus TCP/IP option if installed. Refer to Connect Modbus TCP/IP (Ethernet) on page 27.	
Connect the Modbus RTU option if installed. Refer to Connect Modbus RTU (RS485) on page 24.	
Make sure that there are no loose electrical connections in the analyzer.	
Plumbing:	
The orientation of the ferrules used to connect the tubing is important. Refer to Tube connections on page 29.	
Plumb a sample stream(s) to a SAMPLE fitting(s) on the analyzer. Connect a piece of tubing to the MANUAL fitting(s). Refer to Plumb the sample stream(s) and manual stream(s) on page 30.	
Plumb the drain lines. Refer to Plumb the drain lines on page 33.	
Plumb an oxygen supply to the OXYGEN fitting. Refer to Connect oxygen on page 35. <i>Note: If an oxygen concentrator is installed in the analyzer, the analyzer does not have an OXYGEN fitting.</i>	
Plumb the EXHAUST fitting to a ventilated area. Refer to Plumb the exhaust on page 36.	
Plumb the reagent containers to the fittings on the right side of the analyzer. Refer to Plumb the reagents on page 36.	
Install the tubing on the pumps that have clear covers. Refer to Install the pump tubing on page 40.	
Install the pump tube rails on the pumps that do not have clear covers. Refer to Install the pump tube rails on page 40.	
Connect the tubes that were disconnected for shipping. Refer to Connect the internal tubing on page 41.	
Make sure that there are no loose plumbing connections in the analyzer.	
If the analyzer is supplied as an "air purge ready" system (no fan) or there are corrosive gasses in the area, connect the air purge to the analyzer. Refer to Connect the air purge on page 41.	
Connect the optional sampler if supplied. Refer to the sampler documentation for instructions.	
Look at all of the tubes and connections for possible leaks. Repair the leaks found.	
Startup:	
Set the circuit breaker for the analyzer to on.	
Set the main power switch to on. The main power switch is near the mains power terminal.	
Set the language that shows on the display. Default: English. Refer to Set the language on page 43.	

Installation and startup checklist

Task	Initial
Set the time and date on the analyzer. Refer to Set the time and date on page 43.	
Adjust the display brightness as necessary. Refer to Adjust the display brightness on page 43.	
Identify if there is CO ₂ contamination in the oxygen supply. Refer to Examine the oxygen supply on page 43.	
Make sure that the pump tubes and pump tube rails are installed correctly. Refer to Examine the pumps on page 44.	
Make sure that the valves open and close correctly. Refer to Examine the valves on page 45.	
Select MAINTENANCE > DIAGNOSTICS > SIMULATE > OXIDATION PHASE SIM. Select MFC. Set the flow to 20 L/h. Push ✓ to start the mass flow controller (MFC).	
Make sure that the oxygen regulator shows 350 mbar at 20 L/h. Refer to Analysis enclosure on page 46 for the location.	
Set the reagent volumes on the analyzer and start a new reagent cycle. Refer to Set the reagent volumes on page 45. Note: The new reagent cycle includes a zero calibration. Make sure to plumb the ZERO fitting to deionized water for zero calibrations. Approximately 500 to 800 mL of deionized water is used for a zero calibration or zero check. If the CO ₂ peak values on the display are not almost zero, do a pH test. Refer to the instruction in the Maintenance manual.	
Push ← to go to the main menu, then select OPERATION > START,STOP > START to start the analyzer. Do 5 to 10 measurements until the measurements are stable.	
Do another zero calibration. Select CALIBRATION > ZERO CALIBRATION > RUN ZERO CALIBRATION.	
Measure deionized water five times at operation range 1 to make sure that the zero calibration is correct. Connect deionized water to the MANUAL fitting. Refer to Measure deionized water on page 62.	
Push ← to go to the main menu, then select OPERATION > START,STOP > START to start the analyzer.	
When the startup tests are complete, make sure that the top-left corner of the Reaction Data screen does not show "SYSTEM FAULT" or "SYSTEM WARNING". Note: If "SYSTEM FAULT" or "SYSTEM WARNING" show, select OPERATION > FAULT ARCHIVE. Faults and warnings preceded by an "*" are active. Refer to <i>Troubleshooting in the Maintenance and Troubleshooting Manual</i> for more information.	
Configuration:	
Set the INTERVAL setting to set the time between reactions. Refer to Set the measurement interval on page 49.	
Set the sample pump forward and reverse times for each sample stream. Refer to Set the sample pump times on page 49.	
Set the stream sequence, the number of reactions to do at each stream and the operation range for each stream. Refer to Set the stream sequence and operation range on page 50. Note: If Modbus RTU or TCP/IP is installed, the Modbus master controls the stream sequence and operation ranges (default).	
(Optional) Set the analyzer to show the calculated COD and/or BOD result on the display. Refer to Configure the COD and BOD settings on page 51.	
Configure the install new reagents settings. Refer to Configure the install new reagents settings on page 52.	
Configure the alarm settings for low reagents and no reagents. Refer to Set reagent monitoring on page 52.	
Configure the analog outputs that are connected to an external device. Refer to Configure the analog outputs on page 53.	
Configure the relays that are connected to an external device. Refer to Configure the relays on page 55.	
Make sure that the operation of the digital inputs and digital outputs is correct. Refer to the instructions in the Maintenance manual.	

Task	Initial
If the optional Modbus TCP/IP module is installed in the analyzer, configure the Modbus settings. Refer to Configure the Modbus TCP/IP settings on page 58.	
Set the PRINT MODE setting to select the type of reaction data saved to the MMC/SD card (STANDARD or ENGINEERING) and the type of decimal point (POINT (.) or COMMA (,)). Refer to Configure the communication settings on page 58. <i>Note: The manufacturer recommends that PRINT MODE is set to ENGINEERING so that troubleshooting data is saved.</i>	
Calibration:	
Let the analyzer operate for 24 hours for measurements to become stable.	
Set the operation range and the calibration standard for span calibrations. Refer to Start a span calibration or span check on page 63.	
Plumb the calibration standard to the MANUAL\CALIBRATION fitting. Refer to Plumb the calibration standard on page 64.	
Start a span calibration. Select CALIBRATION > SPAN CALIBRATION > RUN SPAN CALIBRATION.	
When the span calibration is complete, examine two or three reactions (measurements). Make sure that the CO ₂ peak values are correct. Refer to Reaction Graph screen on page 69.	
Set the days and time when the analyzer does a span calibration, span check, zero calibration and/or zero check. Refer to the instructions in the Advanced Configuration manual.	
Save the changes:	
Put the supplied MMC/SD card in the MMC/SD card slot if not already installed. Refer to Figure 18 on page 43.	
Push  to go to the main menu, then select MAINTENANCE > DIAGNOSTICS > DATA OUTPUT > SEND ALL DATA to save the reaction archive, fault archive, analyzer settings and diagnostics data to the MMC/SD card.	

Section 4 Installation

⚠ DANGER



Multiple hazards. Only qualified personnel must conduct the tasks described in this section of the document.

4.1 Installation guidelines

- Install the analyzer near an open drain. The analyzer waste usually has a low pH (acidic) and can be hazardous. Refer to local regulatory agency instructions for disposal.
Note: When the self-cleaning feature of the sample line is set to on (default), the analyzer waste exits the analyzer through the sample inlet tubing into the sample stream, which cleans the sample inlet tubing. When the self-cleaning feature is set to off, the analyzer waste exits the analyzer through the drain line. To set the self-cleaning feature to off, set the pump reverse time to 0. Refer to [Set the sample pump times](#) on page 49.
- Install the analyzer as near to the sampling point as possible to decrease analysis delay.
- Install the analyzer indoors in a clean, dry, well-ventilated and temperature-controlled location. Refer to the operating temperature and humidity specifications in [Specifications](#) on page 3.
- Mount the analyzer upright and level on a flat, vertical surface.
- Do not install the analyzer in direct sunlight or near a heat source.
- Install the analyzer so that the power disconnect device is visible and easily accessible.
- If the analyzer has a Class 1 Division 2 or ATEX Zone 2 hazardous area certification, read the hazardous area documentation supplied with the analyzer. The documentation contains important compliance information and explosion protection regulations.

4.2 Wall mount

⚠ WARNING



Personal injury hazard. Make sure that the wall mounting is able to hold 4 times the weight of the equipment.

⚠ WARNING



Personal injury hazard. Instruments or components are heavy. Use assistance to install or move.

NOTICE

To prevent instrument damage, make sure that there is at least 300 mm (12 in.) of clearance on the sides and 1500 mm (59 in.) in the front of the analyzer. Refer to [Figure 2](#) for dimensions.

1. Attach the wall mounting brackets to the back of the analyzer. Refer to the documentation supplied with the wall mounting brackets.
2. Install mounting hardware on a wall that can hold 4 times the weight of the analyzer (size M8 bolts minimum). Refer to [Figure 2](#) for the mounting hole dimensions.
Refer to [Specifications](#) on page 3 for the weight of the analyzer. Mounting hardware is supplied by the user.

Installation

3. Lift the analyzer with a forklift to attach the analyzer to the wall with the wall mounting brackets.
4. Make sure that analyzer is level.

Figure 2 Mounting hole dimensions

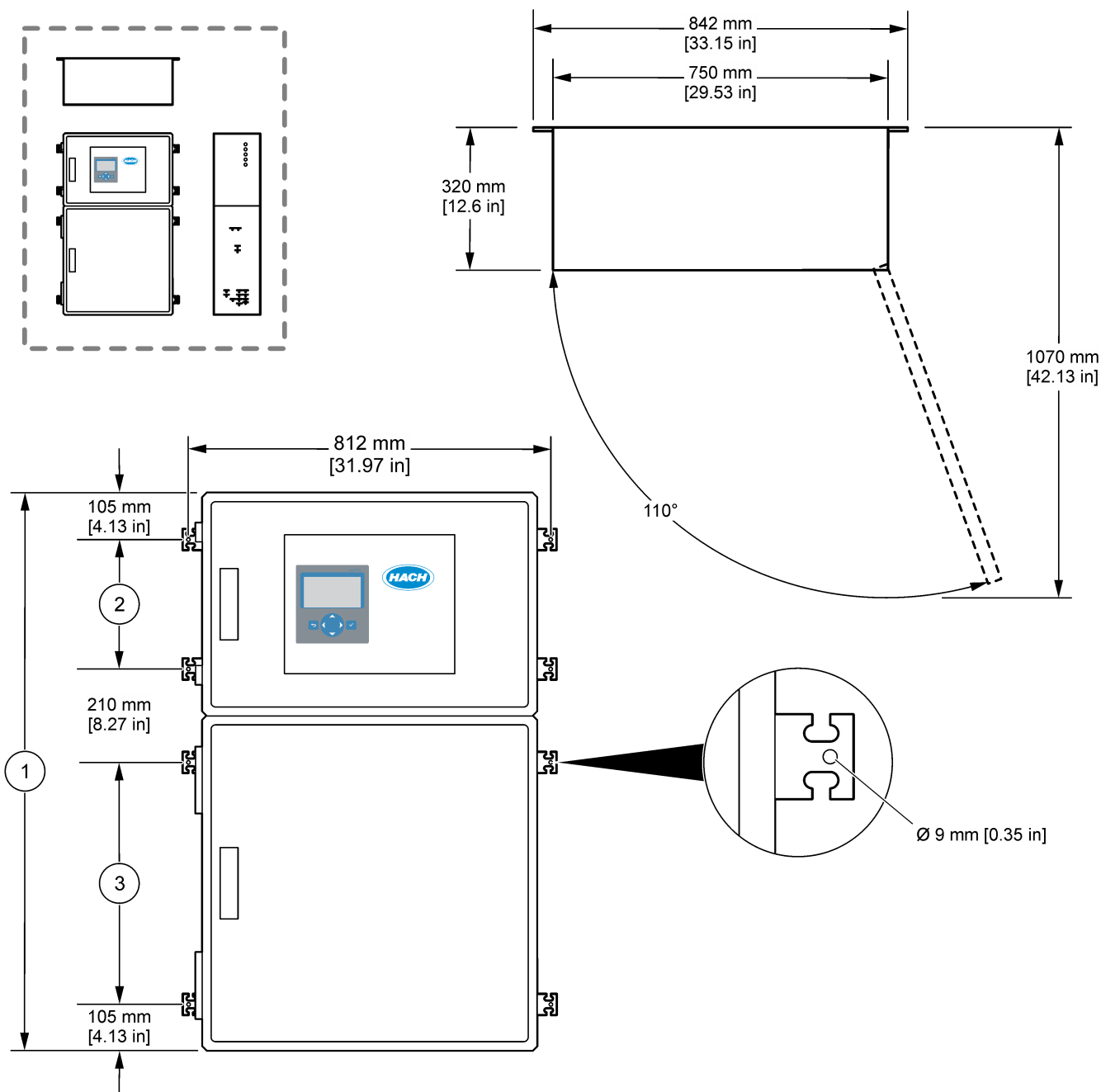

<p>1 1250 to 1750 (49.2 to 68.9 in.), depending on system optional features</p>	<p>3 540 mm (21.26 in.) or 710 mm (27.95 in.) with extended lower enclosure</p>
<p>2 290 mm (11.42 in.) or 540 mm (21.26 in.) with internal oxygen concentrator</p>	

4.3 Electrical installation

⚠ DANGER



Electrocution hazard. Always remove power to the instrument before making electrical connections.

⚠ CAUTION



Multiple hazards. This instrument must be installed by Hach trained installation engineer in accordance with local and regional electrical codes.

The analyzer is a permanently wired device and configured for 120V or 240V as indicated on the product type label on the left side of the upper enclosure.

4.3.1 Electrostatic discharge (ESD) considerations

NOTICE



Potential Instrument Damage. Delicate internal electronic components can be damaged by static electricity, resulting in degraded performance or eventual failure.

Refer to the steps in this procedure to prevent ESD damage to the instrument:

- During service, make sure that ESD precautions are maintained.
- Avoid excessive movement. Transport static-sensitive components in anti-static containers or packages.
- Wear a wrist strap connected by a wire to earth ground.
- Work in a static-safe area with anti-static floor pads and work bench pads.

4.3.2 Open the doors

NOTICE

Make sure that the door handles are fully turned before the doors are opened or damage to the door seals can occur. If the door seals have damage, dust and liquid can enter the enclosures.

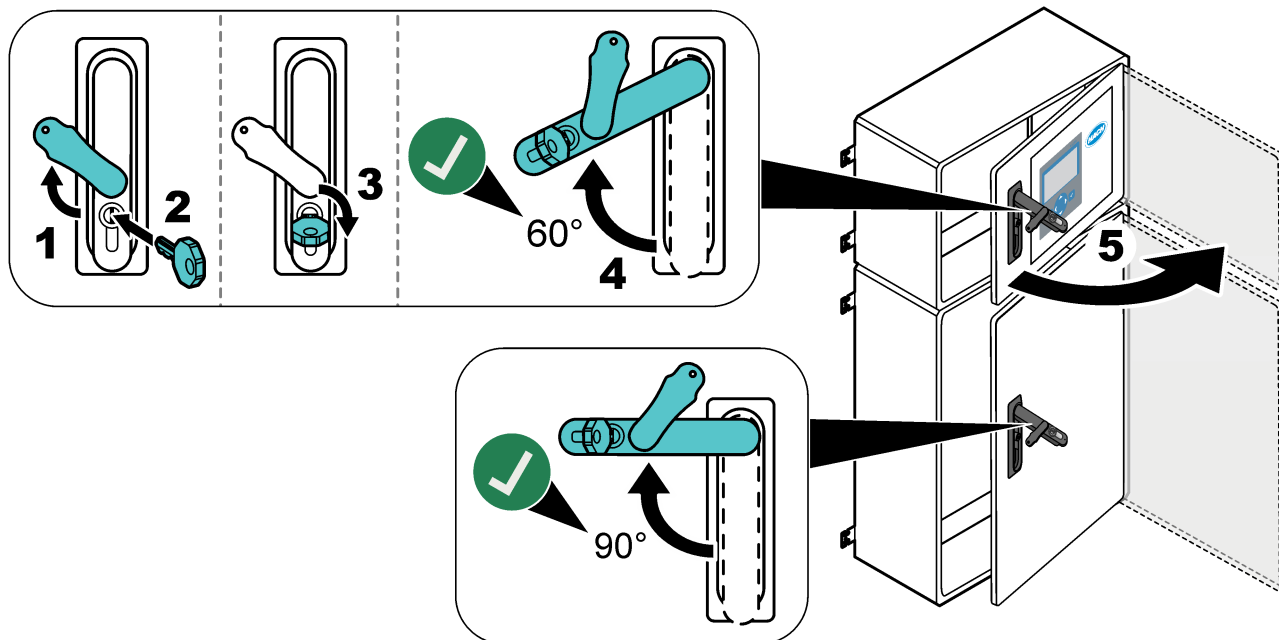

4.3.3 Connect power

⚠ DANGER	
	Electrocution hazard. Protective Earth Ground (PE) connection is required.

⚠ DANGER	
	Electrical shock and fire hazards. Make sure to identify the local disconnect clearly for the installation.

⚠ WARNING	
	Potential electrocution hazard. If this equipment is used in potentially wet locations, a Ground Fault Interrupt device must be used for connecting the equipment to its mains power source.

NOTICE	
Install the device in a location and position that gives easy access to the disconnect device and its operation.	

Do not use a power cord to supply power. Refer to [Power, analog output and relay terminals](#) on page 22 to connect power.

The analyzer is a permanently wired device and configured for 120V or 240V as indicated on the product type label on the left side of the upper enclosure. The analyzer requires a dedicated branch circuit protected power source and an isolator within 1 m (3.3 ft).

- Install a 2-pole, 10 A maximum local disconnect switch for the analyzer within 2 m (6.5 ft) of the analyzer. Put a label on the disconnect that identifies it as the main disconnect device for the analyzer.
- Make sure that the mains wire power and safety ground service drops for the analyzer are a 2-wire and protective earth cable, 1.5 mm² (16 AWG), 10 A minimum and the wire insulation is rated 300 VAC minimum, 60 °C (140 °F) minimum and VW-1 for fire.
Use a shielded mains power cable connected to a shielded earth to comply with the Electromagnetic Compatibility Directive (2004/108/EC).
Use SJT, SVT SOOW or <HAR> equivalent cable as applicable to the application.
- Connect the disconnect switch to a branch circuit/miniature circuit breaker (MCB) protection rated 10 A/ Type D. Install an earth leakage circuit breaker in accordance with local and regional regulations if applicable.
- Connect equipment in accordance with local, regional or national electrical codes.
- Typically, five cable glands (strain relief fittings) are supplied with the analyzer. PG13.5 cable glands have a clamping range of 6–12 mm. PG11 cable glands have a clamping range of 5–10 mm.

4.3.4 Connect the relays

⚠ DANGER	
	Electrocution hazard. Do not mix high and low voltage. Make sure that the relay connections are all high voltage AC or all low voltage DC.

⚠ WARNING

Potential Electrocution Hazard. Power and relay terminals are designed for only single wire termination. Do not use more than one wire in each terminal.

⚠ WARNING

Potential fire hazard. Do not daisy-chain the common relay connections or jumper wire from the mains power connection inside the instrument.

⚠ CAUTION

Fire hazard. Relay loads must be resistive. Always limit current to the relays with an external fuse or breaker. Obey the relay ratings in the Specifications section.

The analyzer has three non-powered relays. Two relays are programmable (Relay 18 and Relay 19) and one relay is for system fault (Relay 20). The relays are rated at 1 A, 30 VDC maximum.

Use the relay connections to start or stop an external device such as an alarm. Each relay changes state when the selected condition for the relay occurs.

Refer to [Power, analog output and relay terminals](#) on page 22 and [Table 7](#) to connect an external device to a relay. Refer to [Configure the relays](#) on page 55 to select the condition that sets each relay to on.

The relay terminals accept 1.0 to 1.29 mm² (18 to 16 AWG) wire (as determined by load application)⁶. Wire gauge less than 18 AWG is not recommended. Use wire with an insulation rating of 300 VAC or higher. Make sure that the field wiring insulation is rated 80 °C (176 °F) minimum.

Make sure to have a second switch available to remove power from the relays locally if there is an emergency or for maintenance.

Table 7 Wiring information—relays

NO	COM	NC
Normally open	Common	Normally closed

4.3.5 Connect the analog outputs

The analyzer has a maximum of six 4–20 mA analog outputs. Use the analog outputs for analog signaling or to control external devices.

Refer to [Power, analog output and relay terminals](#) on page 22 to connect an external device to an analog output.

Depending on the configuration and options installed on the analyzer, the minimum specifications for signal and communications cable is 4 wires (twisted pair, shielded cable) and more 2 wires for each additional signal, 0.22 mm² (24 AWG) minimum and rated 1 A.

Select the full scale value shown as 20 mA on each analog output. Select the analysis result each analog output shows. Refer to [Configure the analog outputs](#) on page 53.

Notes:

- The analog outputs are isolated from the other electronics, but are not isolated from each other.
- The analog outputs are self-powered. Do not connect to a load with voltage that is independently applied.

⁶ Recommend 1.0 mm² (18 AWG) minimum stranded UL/AWM Style 1015 rated 600 V, 105 °C, VW-1.

Installation

- The analog outputs cannot be used to supply power to a 2-wire (loop-powered) transmitter.

4.3.6 Power, analog output and relay terminals

Refer to [Figure 3](#) for the location of the mains power, analog output and relay terminals. [Table 8](#) shows the terminal descriptions. In addition, terminal descriptions are available on the top door.

Make electrical connections through the cable strain-relief fittings on the side of the analyzer. Use the top strain-relief fitting for the mains power cable.

To keep the environmental rating:

- Do not put more than one cable (or two wires) through a strain-relief fitting.
- Make sure that the strain-relief fittings that are unused have rubber cable plugs in them.

Figure 3 Location of mains power, analog output and relay terminals

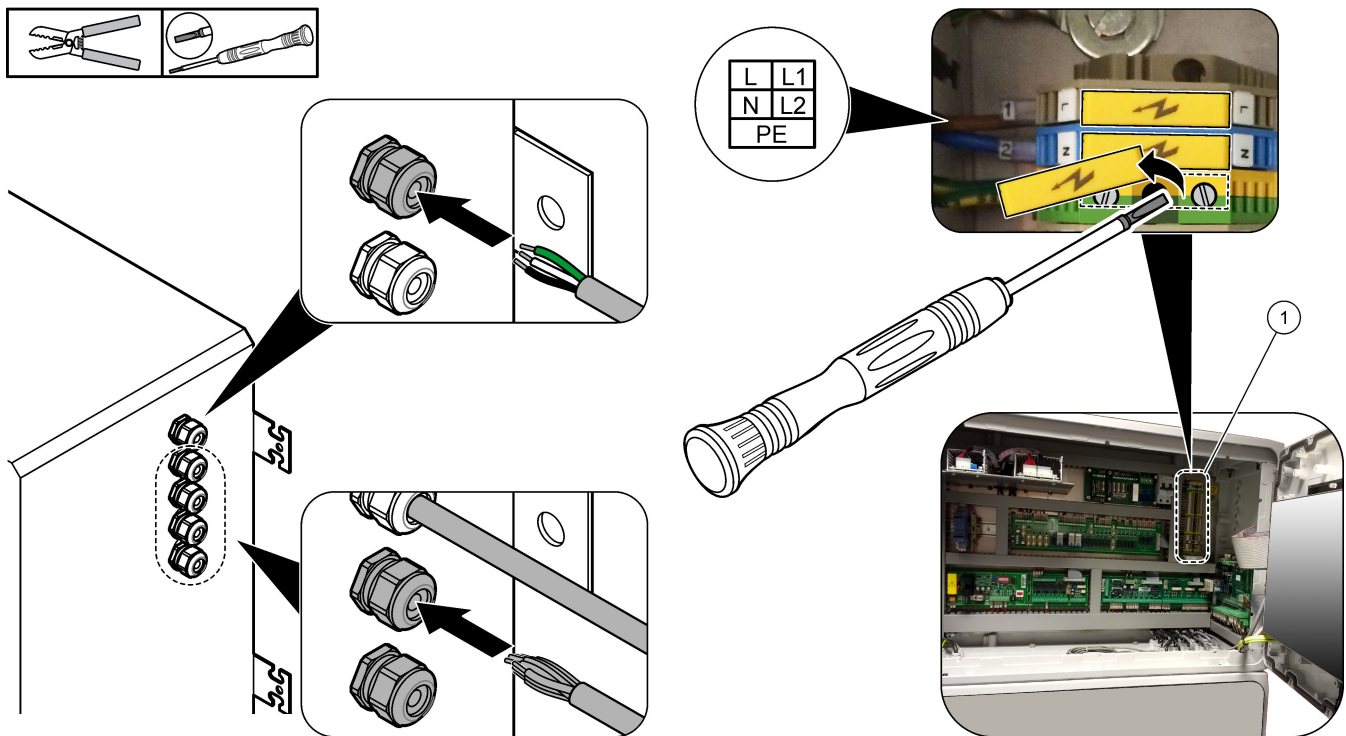

1 Power, analog output and relay terminals

Table 8 Power, analog output and relay terminals



Terminal	Description	Terminal	Description
L/L1	100–120 VAC or 200–230 VAC 1 phase	12	4–20 mA signal out +, 1
N/L2	Neutral (or L2 for US and Canada)	13	4–20 mA signal out –, 1
	Protective earth for mains power and screened earth cable	14	4–20 mA signal out +, 2
3	Relay 18, NC	15	4–20 mA signal out –, 2
4	Relay 18, COM	16	4–20 mA signal out +, 3
5	Relay 18, NO	17	4–20 mA signal out –, 3
6	Relay 19, NC	...	

Table 8 Power, analog output and relay terminals (continued)

Terminal	Description	Terminal	Description
7	Relay 19, COM	32	4–20 mA signal out +, 4
8	Relay 19, NO	33	4–20 mA signal out +, 4
9	Relay 20 (fault relay ⁷), NC	34	4–20 mA signal out +, 5
10	Relay 20 (fault relay), COM	35	4–20 mA signal out +, 5
11	Relay 20 (fault relay), NO	36	4–20 mA signal out +, 6
	Shielded earth	37	4–20 mA signal out +, 6
			Shielded earth

4.3.7 Optional digital inputs, modules and relays

Optional digital inputs, modules and relays are installed below the terminals for the mains power, analog output and relays.

The labels on the options are given in [Table 9](#).

Terminal descriptions for the installed options are available on the top door.

Table 9 Optional digital inputs, modules and relays

Label	Description
MODBUS	Modbus TCP/IP module
Sync (synchronization)	Digital output used to synchronize the analyzer with an external control unit. Sets the next stream and operation range.
Stream 1	Digital input that sets the next measurement to be a STREAM 1 (Sample 1) measurement. Use an active 24 VDC signal from a PLC (programmable logic control) system for the digital input.
Stream 2	Digital input that sets the next measurement to be a STREAM 2 (Sample 2) measurement. Use an active 24 VDC signal from a PLC system for the digital input.
Stream 3	Digital input that sets the next measurement to be a STREAM 3 (Sample 3) measurement. Use an active 24 VDC signal from a PLC system for the digital input.
Stream 4	Digital input that sets the next measurement to be a STREAM 4 (Sample 4) measurement. Use an active 24 VDC signal from a PLC system for the digital input.
Stream 5	Digital input that sets the next measurement to be a STREAM 5 (Sample 5) measurement. Use an active 24 VDC signal from a PLC system for the digital input.
Stream 6	Digital input that sets the next measurement to be a STREAM 6 (Sample 6) measurement. Use an active 24 VDC signal from a PLC system for the digital input.
Range IP21	Two digital inputs that set the operation range. AUTO range = IP20 off (0 VDC) + IP21 off (0 VDC)
Range IP20	Range 1 = IP20 on (24 VDC) + IP21 off (0 VDC) Range 2 = IP20 off (0 VDC) + IP21 on (24 VDC) Range 3 = IP20 on (24 VDC) + IP21 on (24 VDC) Use an active 24 VDC signal from a PLC system for the digital input.
Remote Standby	Digital input that sets the analyzer to remote standby mode. Use an active 24 VDC signal from a PLC system for the digital input.
Output	Configurable relay; volt free contacts, 1 A at 30 VDC maximum

⁷ Relay 20 is not configurable. Relay 20 is the fault relay. The fault relay is active when a system fault occurs.

4.3.8 Connect Modbus RTU (RS485)

If the Modbus RTU option is installed in the analyzer, connect the Modbus RTU terminals in the analyzer to a Modbus master device as follows:

Note: The Modbus register maps are supplied in the Advanced Configuration Manual.

1. Remove power to the analyzer. Refer to the illustrated steps in [Figure 4](#).
2. Put a 2-wire, twisted pair, shielded cable through a cable strain-relief fitting on the right side of the analyzer. Use wire gauge of 0.2 mm² (24 AWG) minimum.
3. Connect three of the wires to the Modbus RTU terminals in the analyzer. Refer to [Figure 5](#) and [Table 10](#) for wiring information.
Refer to [Figure 6](#) for the location of the Modbus RTU terminals in the analyzer.
4. Connect the shield wire of the cable to the earth ground terminal in the analyzer.
Note: As an alternative, connect the shield wire to the ground terminal of the Modbus master device.
5. Tighten the cable strain-relief fitting.
6. Connect the other end of the cable to a Modbus master device. Refer to [Figure 5](#).
7. Make sure that the wire connected to terminal 58 (D+) is positively biased compared to terminal 59 (D-) when the bus is in an idle condition.
8. To terminate the bus, install a jumper on J15 of the motherboard. Refer to [Figure 6](#).
The motherboard is in the electronic enclosure on the door behind the stainless steel cover.

Figure 4 Remove power to the analyzer

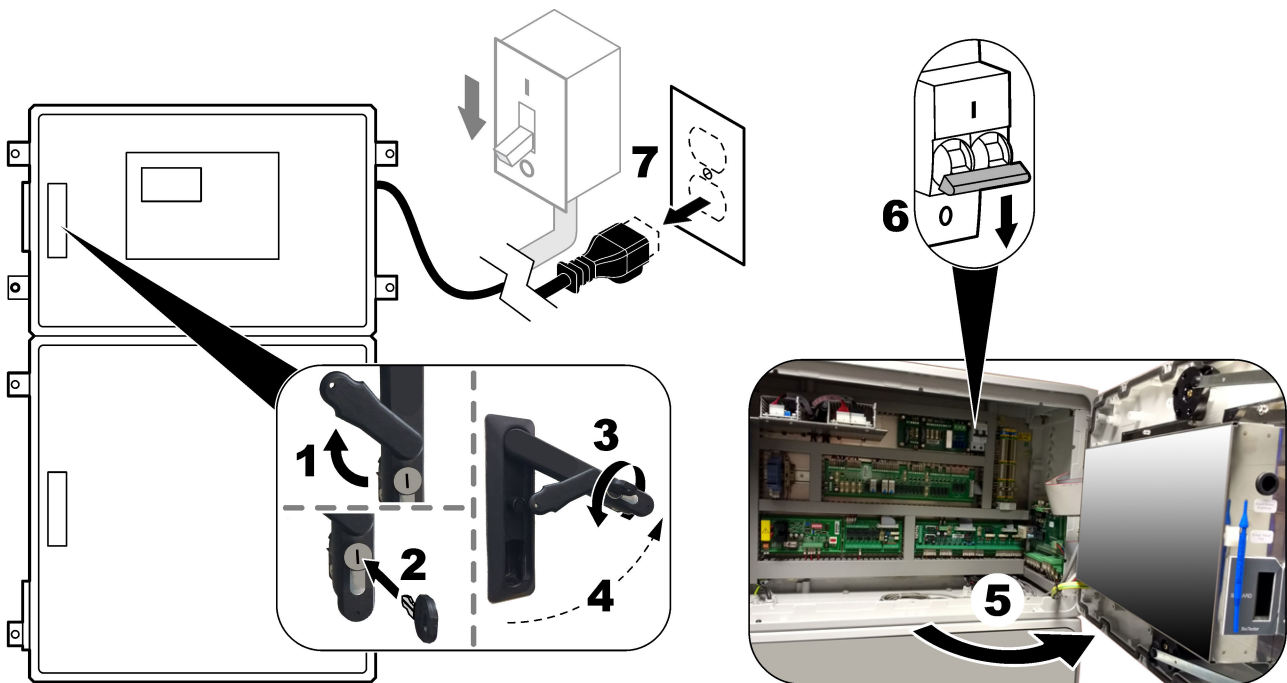
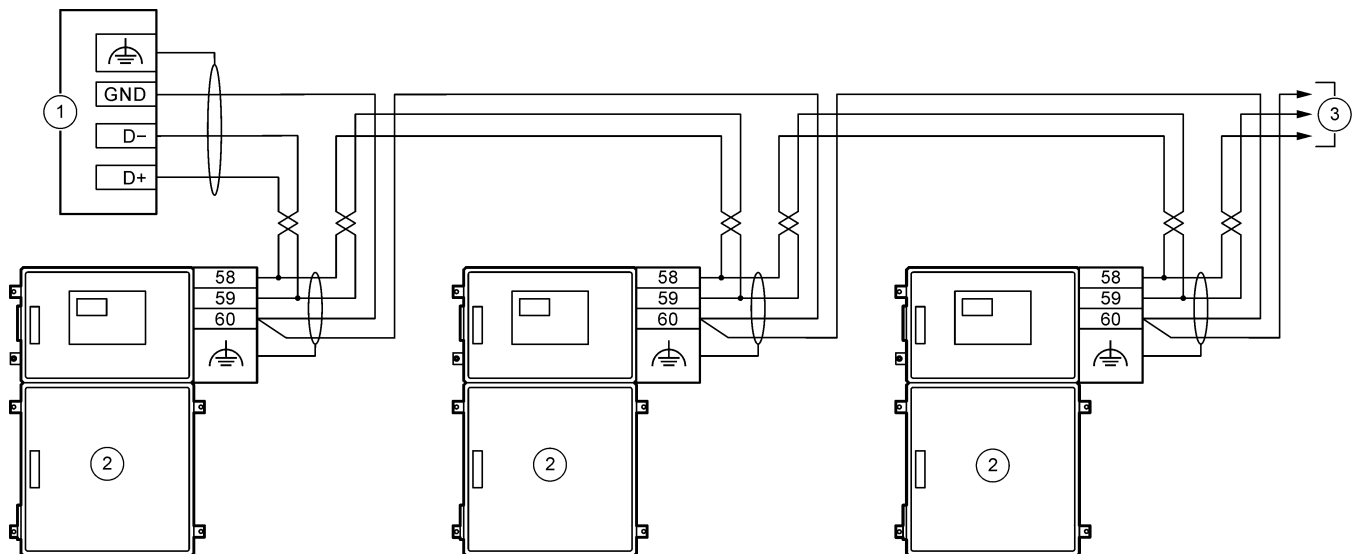



Figure 5 Wiring diagram



1 Modbus master	3 To other RS485 devices
2 Analyzer	

Table 10 Wiring information

Terminal	Signal
58	D+
59	D-
60	Modbus ground
	Shielded earth

Installation

Figure 6 Location of Modbus RTU terminals and bus-termination jumper

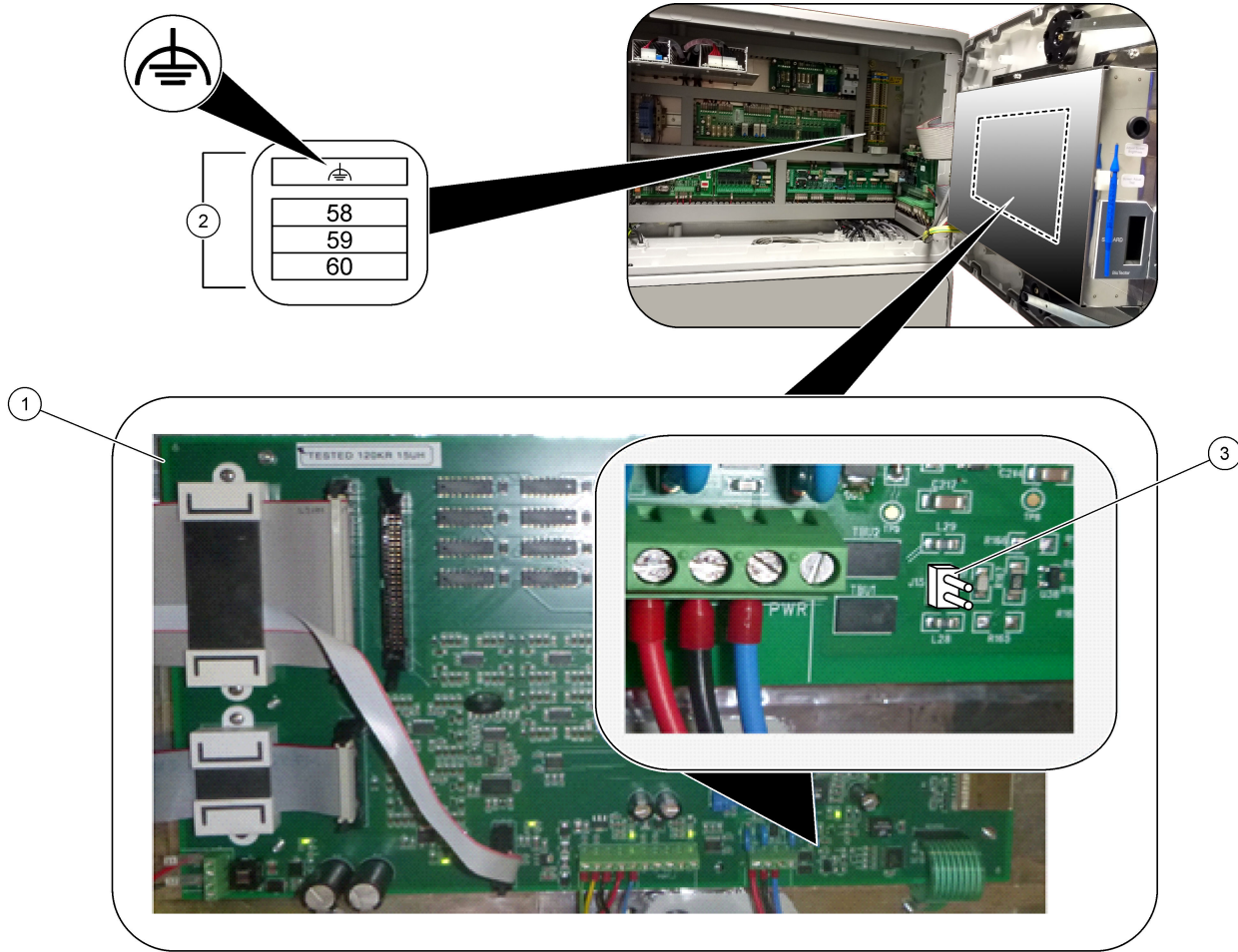

1 Motherboard	3 Bus-termination jumper (J15)
2 Modbus RTU terminals	

4.3.9 Connect Modbus TCP/IP (Ethernet)

If the optional Modbus TCP/IP module is installed in the analyzer, configure the Modbus module and connect the module to a Modbus master device. Refer to the sections that follow.

The Modbus TCP/IP module is marked "MODBUS" and is below the terminals for the mains power, analog output and relays.

4.3.9.1 Configure the Modbus TCP/IP module

1. Set the analyzer power to on.
2. Use an Ethernet cable to connect a laptop to the Modbus TCP/IP (RJ45) connector in the analyzer. Refer to [Figure 7](#) on page 28.
3. On the laptop, click the Start icon and select Control Panel.
4. Select Network and Internet.
5. Select Network and Sharing Center.
6. On the right side of the window, select Change adapter settings.
7. Right-click Local Area Connection and select Properties.
8. Select Internet Protocol Version 4 (TCP/IPv4) from the list, then click **Properties**.
9. Record the properties to go back to the properties in the future as necessary.
10. Select Use the following IP address.
11. Enter the IP address and subnet mask that follow:
 - IP address: 192.168.254.100
 - Subnet mask: 255.255.255.0
12. Click **OK**.
13. Close the open windows.
14. Open a web browser.
15. In the address bar of the web browser, enter the default IP address (192.168.254.254).

The web-interface of the Modbus TCP module shows.
16. Enter the user name and password:
 - User name: Admin
 - Password: admin
17. Use a web-interface at port 80 to change the configuration of the Modbus TCP module, such as the IP address (192.168.254.254) or the TCP/IP port (502).

4.3.9.2 Connect the Modbus TCP/IP module

For Modbus TCP data transmission, connect the Modbus TCP/IP connector in the analyzer to a Modbus master device as follows:

1. Put an Ethernet cable through a cable strain-relief fitting on the right side of the analyzer.
2. Connect the Ethernet cable to the Modbus TCP/IP connector in the analyzer. Refer to [Figure 7](#).
3. Tighten the cable strain-relief fitting.
4. Connect the other end of the Ethernet cable to a Modbus master device. Refer to [Figure 8](#).

If the analyzer has two Modbus TCP/IP connectors, fully redundant data transmission is possible. To connect an analyzer to two Modbus master devices, refer to [Figure 9](#).

Installation

Figure 7 Modbus TCP/IP connector

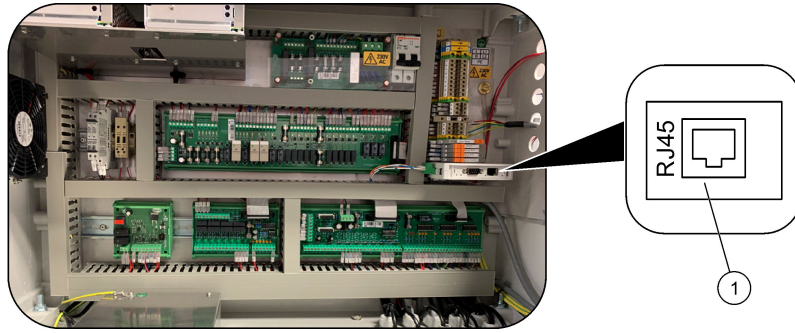

1 Modbus TCP/IP connector

Figure 8 Normal Modbus TCP wiring

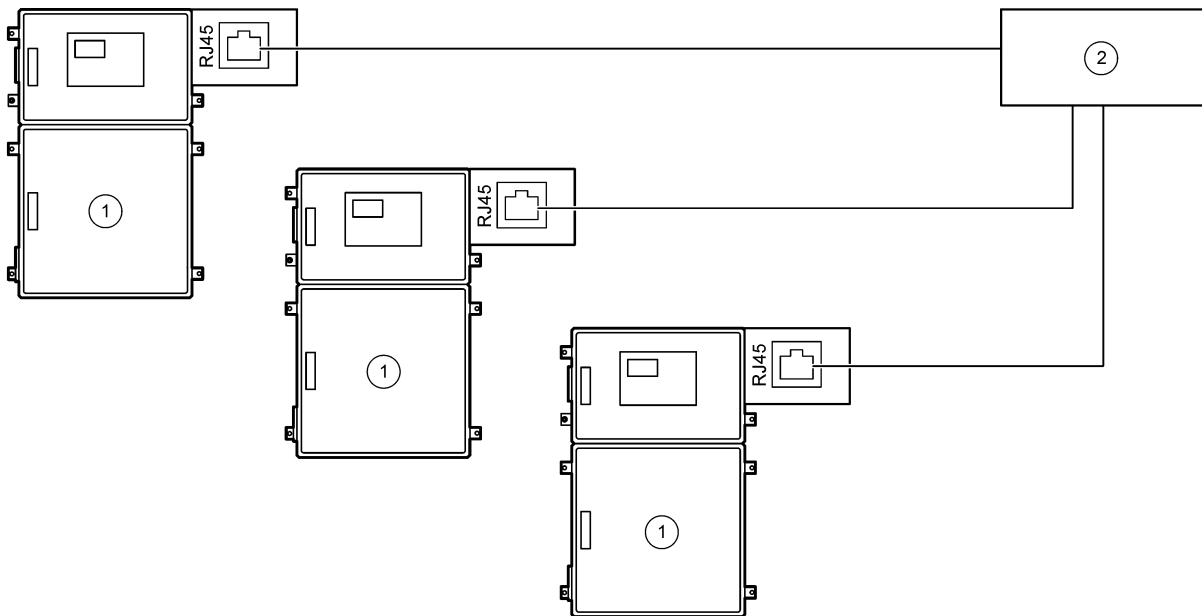

1 Analyzer

2 Modbus master

Figure 9 Redundant Modbus TCP wiring

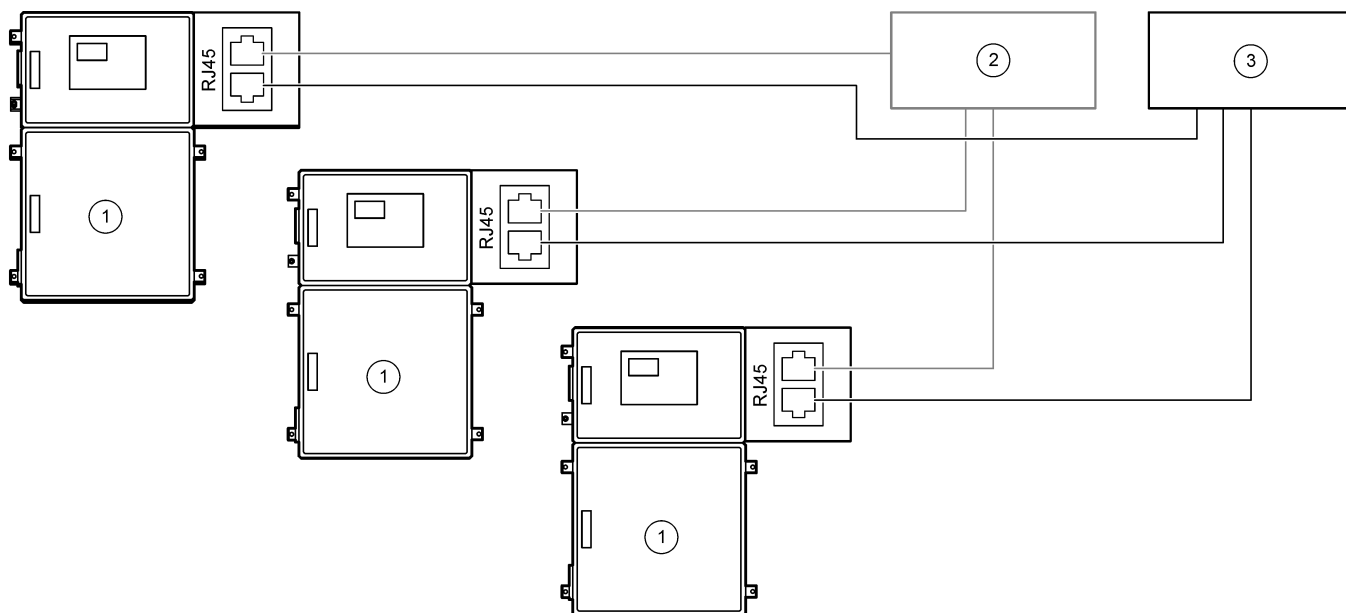

1 Analyzer	3 Modbus Master 2
2 Modbus Master 1	

4.4 Plumbing

4.4.1 Tube connections

The orientation of the ferrules used to connect the tubing is important. Incorrect ferrule orientation can cause leaks and/or air bubbles in the analyzer tubing. Refer to [Figure 10](#) for the correct ferrule orientation.

1. Cut tubing with a tube cutting tool. Do not use a blade or scissors or leaks can occur.
2. Put the tube fully into the fitting.
3. Tighten the nut by hand. If the fittings are tighten too much, damage to the fittings and leaks will occur.
 - **Stainless Steel fittings**—Tighten another 1¼ turn with an adjustable wrench. Stainless steel fittings used on 1/8-in. ID PFA tubing must be tightened only another ¾ of a turn.
 - **PFA fittings**—Tighten another ½ turn with an adjustable wrench.

To tightening a fitting that was tightened before, tighten the number of turns the fitting was tightened before plus a little more with an adjustable wrench.

Figure 10 Ferrule orientation

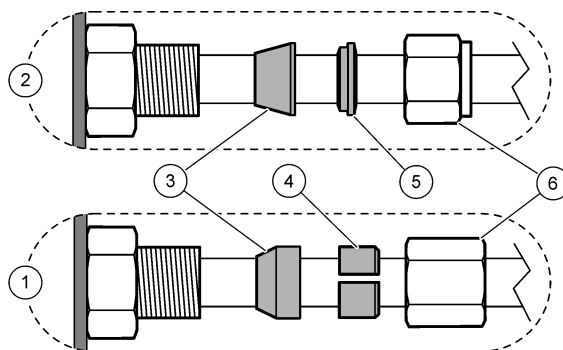

1 PFA and PVDF fittings	3 Front ferrule	5 Back ferrule
2 Stainless steel fittings (SS-316)	4 Back cutting ring	6 Nut

4.4.2 Plumb the sample stream(s) and manual stream(s)

Refer to [Specifications](#) on page 3 for the sample specifications. The sample pressure at the sample inlet must be at ambient pressure.

For pressurized sample streams, install the optional Sample Overflow Chamber in the sample line to supply sample at ambient pressure. Refer to [Install a sample overflow chamber \(optional\)](#) on page 33.

1. Use 1/4-in. OD x 1/8-in. ID PFA tubing to plumb the SAMPLE 1 fitting to a sample stream. Make the sample line as short as possible.
Refer to [Sample line guidelines](#) on page 30 for instructions.
2. Plumb the other SAMPLE fitting(s) to sample streams as necessary.
3. Connect 1/4-in. OD x 1/8-in. ID PFA tubing to the MANUAL fitting(s) as necessary.
Use the MANUAL fittings(s) to measure grab samples and the calibration standard for span calibrations.
4. When all of the tubes are connected, look for possible leaks. Repair the leaks found.

4.4.3 Sample line guidelines

Select a good, representative sampling point for the best instrument performance. The sample must be representative of the entire system.

To prevent erratic readings:

- Collect samples from locations that are sufficiently distant from points of chemical additions to the process stream.
- Make sure that the samples are sufficiently mixed.
- Make sure that all chemical reactions are complete.

Install the sample tubing in an open channel or a pipe as shown in [Figure 11](#) or [Figure 12](#). To connect the sample tube to a metal pipe, use a Swagelok reducer (e.g., SS-400-R-12).

The maximum distance between the water surface and the sample pump is 4 m (13 ft).

Note: When the self-cleaning feature of the sample line is set to on (default), the analyzer waste exits the analyzer through the sample inlet tubing into the sample stream. If the self-cleaning feature is set to off, the analyzer waste exits the analyzer through the drain line. To set the self-cleaning feature to off, set the pump reverse time to 0. Refer to [Set the sample pump times](#) on page 49.

Figure 11 Sample line in an open channel

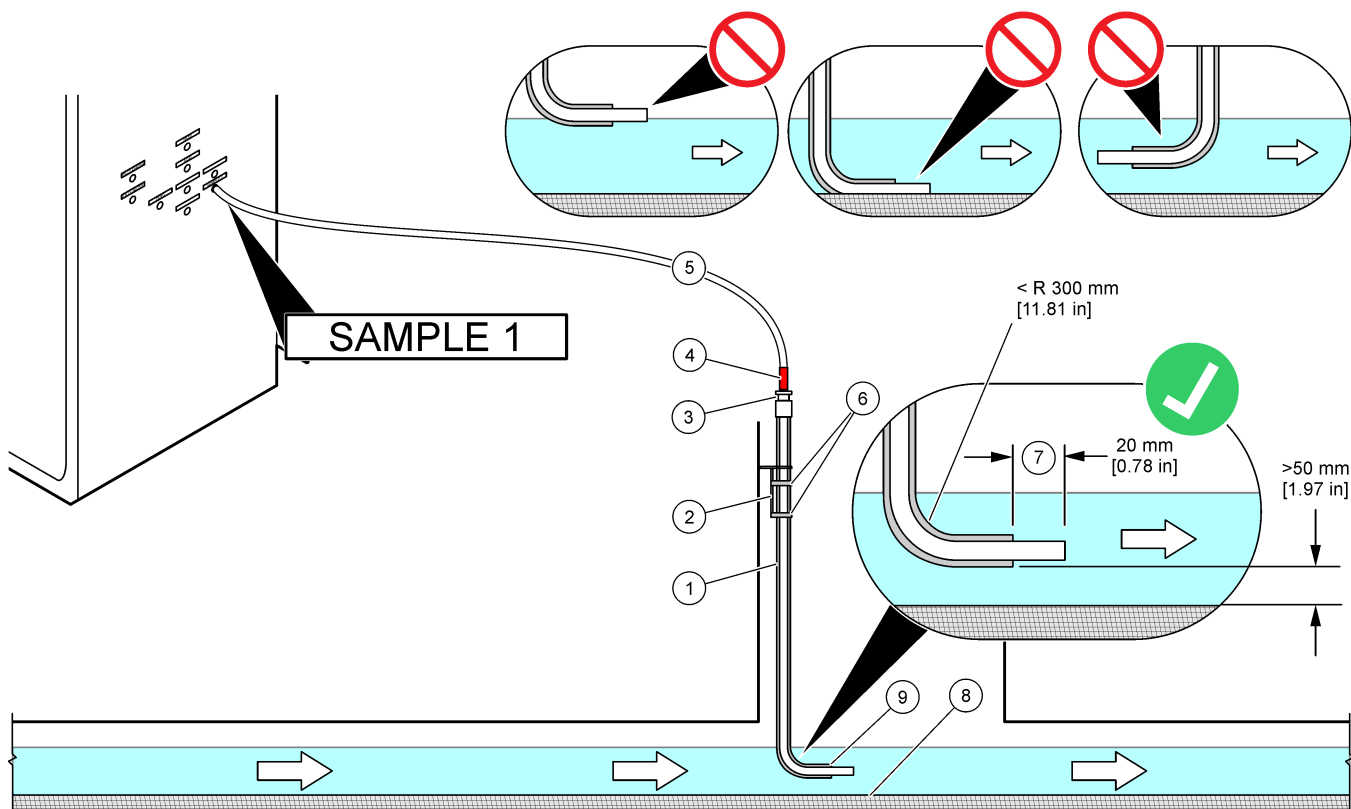

1 Sleeve for sample tubing	4 Depth mark on tube	7 Sample tubing goes past end of sleeve (20 mm)
2 Sleeve bracket	5 Sample tubing, 1/4-in. OD x 1/8-in. ID PFA	8 Silt
3 Compression gland to hold sample tubing	6 Clamps	9 Sleeve opening ⁸

⁸ Sleeve must be below the low water level but more than 50 mm above the silt.

4.4.4 Install a sample overflow chamber (optional)

For pressurized sample streams, install the optional Sample Overflow Chamber (19-BAS-031) in the sample line to supply sample at ambient pressure.

Figure 13 Installation of the sample overflow chamber

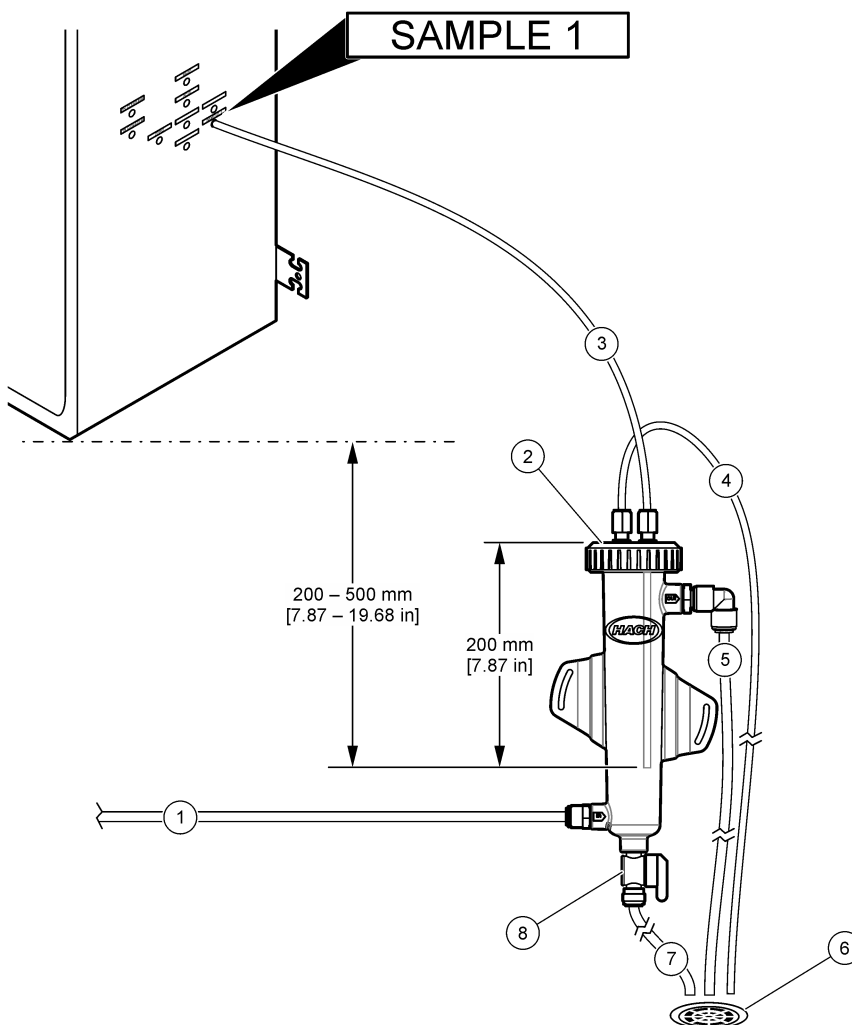

1 Sample inlet tube (flow rate: 0.7 to 1.7 L/min)	4 Vent tube	7 Drain tube
2 Cap	5 Sample overflow tube	8 Manual drain valve
3 Sample tube to analyzer	6 Open drain	

4.4.5 Plumb the drain lines

⚠ CAUTION



Chemical exposure hazard. Dispose of chemicals and wastes in accordance with local, regional and national regulations.

NOTICE

Incorrect installation of the drain lines can cause liquid to go back into the instrument and cause damage.

Make sure that the open drain used for the analyzer is in a ventilated area. Oxygen and very small quantities of carbon dioxide, ozone and volatile gases can be present in the waste liquids plumbed to the drain.

- Make the drain lines as short as possible.
 - Make sure that the drain lines have a constant slope down.
 - Make sure that the drain lines do not have sharp bends and are not pinched.
 - Make sure that the drain lines are open to air and are at zero pressure.
1. Use the supplied 12 mm OD x 10 mm OD PFA tubing to plumb the DRAIN fitting to an open drain. Refer to [Figure 14](#).
 2. Install the supplied PVC-U drain pipe on the right side of the analyzer. Refer to [Figure 14](#). Refer to the documentation supplied with the PVC-U drain pipe.

Note: *If there are chemicals in the sample stream that will damage the supplied PVC-U drain pipe (high concentration solvents such as Benzene or Toluene), use an alternative drain pipe. Make sure that the bypass tubing connects to the replacement drain pipe at the height of the center of the sample (ARS) valve.*

3. Use the supplied 1-inch braided hose and hose clamp to plumb the bottom of the PVC-U drain pipe to an open drain. Refer to [Figure 14](#).

Figure 14 Plumb the drains

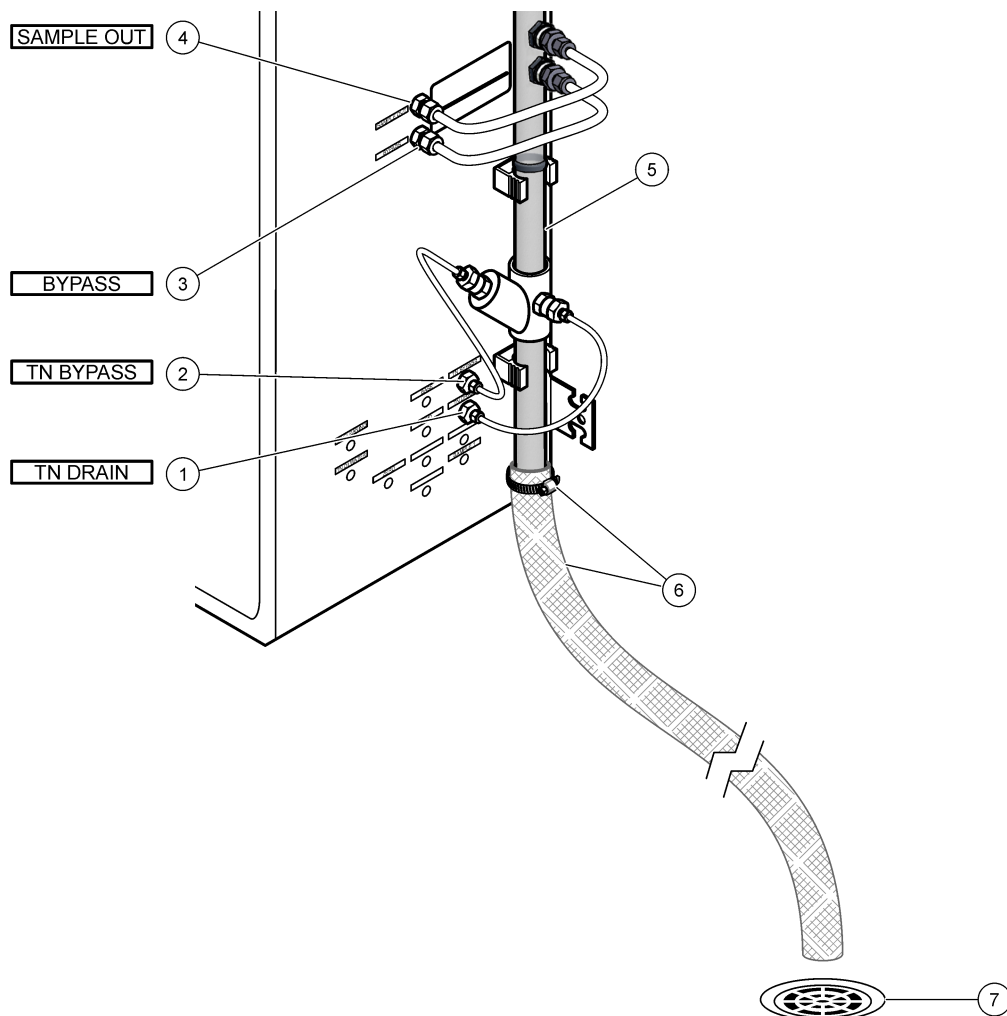

1 TN DRAIN fitting	4 SAMPLE OUT fitting	7 Open drain
2 TN BYPASS fitting	5 PVC-U drain pipe	
3 BYPASS fitting	6 1-inch braided hose and hose clamp	

4.4.6 Connect oxygen

Use ¼-in. OD tubing to connect an oxygen supply to the OXYGEN fitting.

Oxygen pressure:

- Oxygen concentrator plumbed to filtered instrument air— 200 L/h at less than 0.6 bar (8.7 psi). Instrument air pressure: 2.1 bar (30.5 psi, 90 L/minute)
- Oxygen concentrator with integrated air compressor—200 L/h at less than 0.6 bar (8.7 psi)
- Oxygen cylinder, 50 L (welding grade)—1.0 mbar (14.5 psi)

Oxygen quality: Oxygen with no carbon dioxide, carbon monoxide, nitrogen, hydrocarbons or water (93% oxygen minimum and the remaining gas is argon). The oxygen supplied by the oxygen concentrator is 93% oxygen minimum and the remaining gas is argon.

Oxygen usage: 22 L/hour (367 mL/minute)

Safety precautions for oxygen:

- Use the same precautions necessary for high-pressure or compressed gas systems.

- Obey all local and national regulations and/or the manufacturer's recommendations and guidelines.
- If oxygen cylinders are used, move the cylinders safely with the appropriate equipment (e.g., carts and hand trucks).
- If oxygen cylinders are used, make sure that the cylinders are labeled for identification and are correctly attached for safe storage and travel.
- Do not use too many adaptors and couplers.
- Keep oxygen away from grease, oil, fat, and other combustible materials.
- Contact a local oxygen manufacturer for the safety precautions for oxygen cylinders and high concentration oxygen.
- If an oxygen concentrator is used, install the oxygen concentrator in a ventilated area. Obey all local and national regulations to prevent a fire.

4.4.7 Plumb the exhaust

Use ¼-in. OD PFA tubing to plumb the EXHAUST fitting to a ventilated area.

The maximum tubing length is 10 m (33 ft). If longer tubing is necessary, use a larger ID tubing or pipe.

Make sure that the tubing has a constant downward slope from the analyzer so condensation or liquid at the outlet of the tubing cannot freeze.

4.4.8 Plumb the reagents

⚠ CAUTION	
	Chemical exposure hazard. Obey laboratory safety procedures and wear all of the personal protective equipment appropriate to the chemicals that are handled. Refer to the current safety data sheets (MSDS/SDS) for safety protocols.
⚠ CAUTION	
	Chemical exposure hazard. Dispose of chemicals and wastes in accordance with local, regional and national regulations.

Plumb the reagents to the analyzer. Refer to [Figure 15](#).

Items supplied by the user:

- Personal protective equipment (refer to MSDS/SDS)
- TN cleaning solution, 20 L—0.5 N HCl and 0.042 M sodium oxalate (NaOx) mixture
- TN DI water, 10 L—Deionized (DI) water (0.1–0.5 µS/cm)
- Base reagent, 20 or 25 L—1.2 N sodium hydroxide (NaOH)
- Acid reagent, 20 or 25 L—1.8 N sulfuric acid (H₂SO₄) that contains 40-mg/L manganese sulfate monohydrate
- Zero water, 5 L—Deionized water (0.1–0.5 µS/cm)

Use deionized water that contains less than 100-µg/L (ppb) of organics, nitrates and phosphates to prepare reagents. For reagent usage, refer to [Table 11](#).

1. Put reagent spill trays (bunds) under the reagent containers to keep spills contained.
2. Assemble the supplied caps for the reagent containers. Refer to the documentation supplied with the caps. Only one of the two acid reagent cap assemblies (19-PCS-021) is used.

Note: If a supplied cap is not the correct size for the reagent container, use the cap that came with the reagent container. Make an opening in the cap and install the supplied tube fitting in the cap.

3. Attach the weight supplied with each cap (stainless steel or PFA) to the end of the reagent tube that will go in the reagent container.

4. Put on the personal protective equipment identified in the safety data sheets (MSDS/SDS).
5. Install the caps on the reagent containers.
 - **Base reagent container**—Install the cap that has a port on the side of the fitting. The port is used to connect the supplied CO₂ filter. Refer to [Figure 15](#). As an alternative to the tube fitting supplied, use a stainless steel fitting. Refer to [Use a stainless steel fitting for the base reagent \(optional\)](#) on page 39.
 - **Acid reagent and zero water containers**—Install a cap that has 1/4-in. OD x 1/8-in. PFA tubing and a stainless steel weight.
 - **TN cleaning and TN DI water containers**—Install a cap that has 1/8-in. OD x 1/16-in. PFA tubing and a PFA weight¹⁰.
6. Remove the tape from the CO₂ filter.
7. Connect the supplied CO₂ filter to the cap of the base reagent container. Refer to [Figure 15](#). Make sure that the connection is air tight.

Note: If atmospheric CO₂ enters the base reagent container, the analyzer TOC readings will increase.
8. Plumb the reagent containers to the reagent fittings on the right side of the analyzer. Refer to [Figure 15](#). Make the reagent lines as short as possible (2 m (6.5 ft) maximum).
9. Tighten the tube fittings on the caps so the tubes stay at the bottom of the reagent containers.

¹⁰ Do not install a stainless steel weight in TN cleaning solution .

Installation

Figure 15 Reagent installation

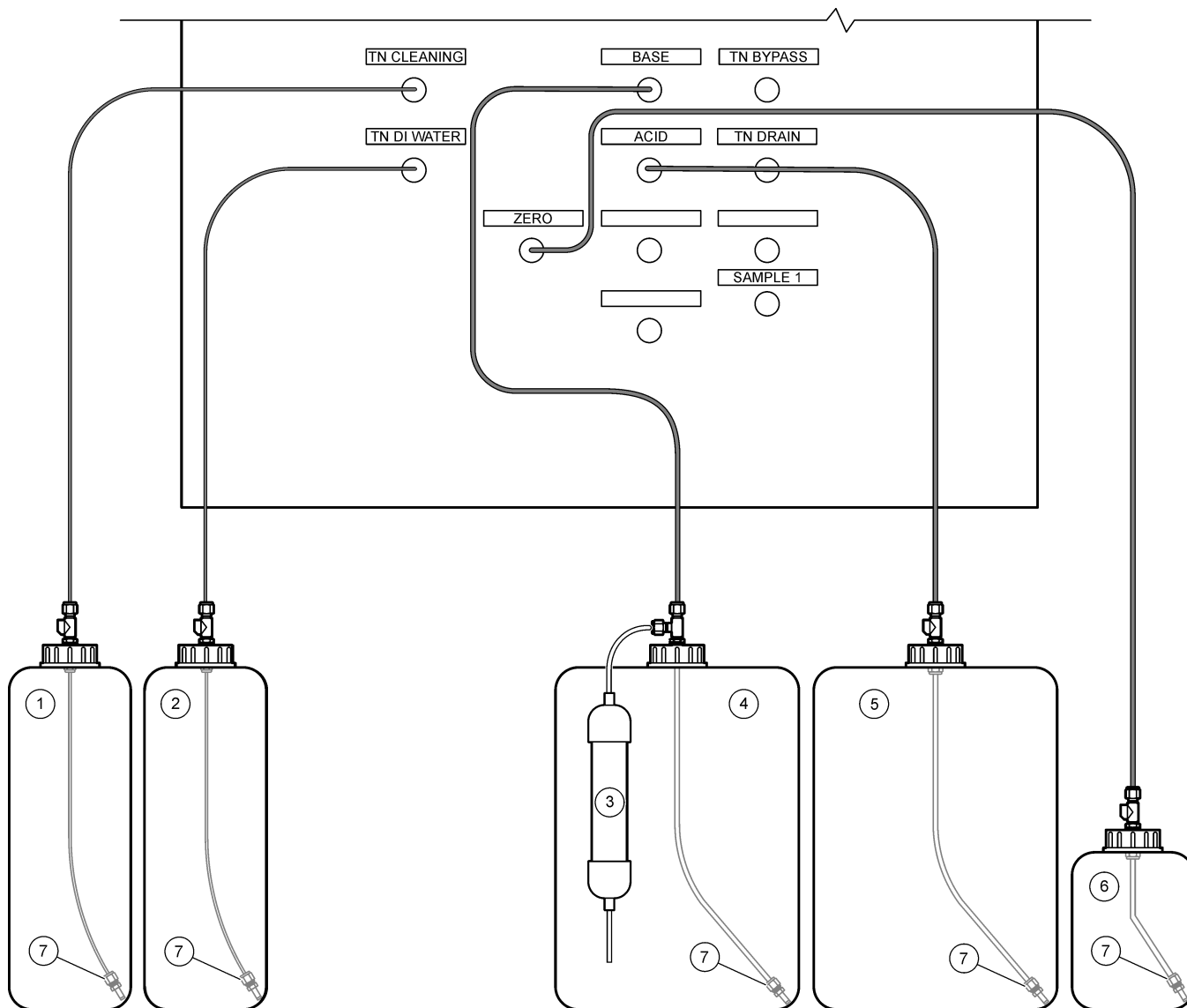

1 TN cleaning solution	5 Acid reagent
2 TN DI water	6 Zero water
3 CO ₂ filter	7 Weight
4 Base reagent	

Table 11 Reagent usage

Reagent	Container size	Low ranges (< 500 mgC/L)	Medium ranges (500 to 2000 mgC/L)	High ranges (> 2000 mgC/L)
Acid	19 L	27 days	17 days	13 days
	20 L	28 days	18 days	14 days
	25 L	35 days	23 days	17 days
Base	19 L	27 days	17 days	13 days
	20 L	28 days	18 days	14 days
	25 L	35 days	23 days	17 days

Table 11 Reagent usage (continued)

Reagent	Container size	Low ranges (< 500 mgC/L)	Medium ranges (500 to 2000 mgC/L)	High ranges (> 2000 mgC/L)
TN cleaning solution	10 L	657 days	657 days	657 days
TN DI water	10 L	193 days	193 days	193 days

4.4.8.1 Use a stainless steel fitting for the base reagent (optional)

As an alternative to the plastic tube fitting supplied for the base reagent container, use a stainless steel fitting. Refer to Figure 16. The tee fitting must supply an air tight seal with the cap. If atmospheric CO₂ enters the base reagent container, the analyzer TIC and TOC readings will increase.

Figure 16 Base reagent container

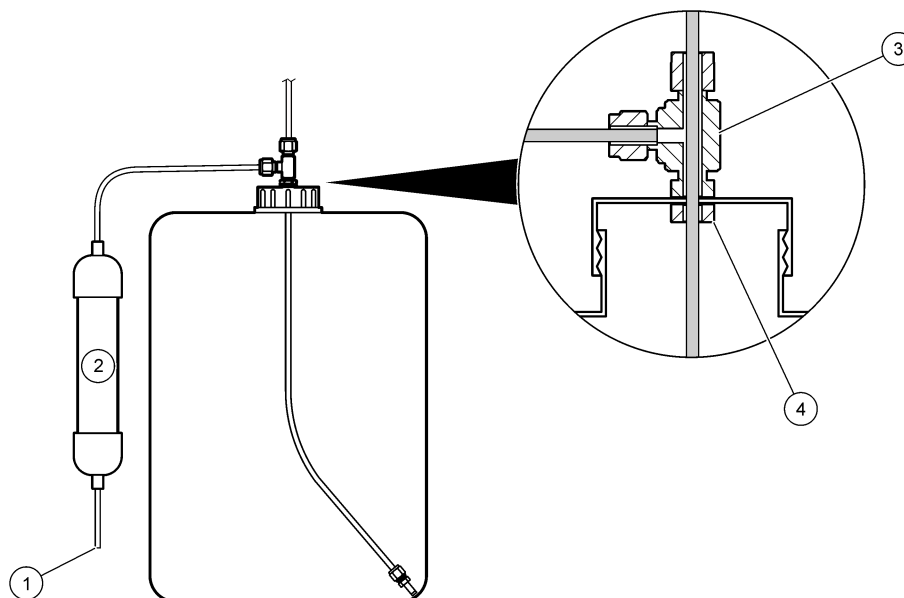

1 Air inlet	3 Swagelok SS-400-3TST tee fitting, drilled to 7.0 mm (0.28 in.)
2 CO ₂ filter	4 Swagelok SS-45ST-N nut

Installation

4.4.9 Install the pump tubing

Install the tubing on the pumps that have clear covers. Refer to the illustrated steps that follow.

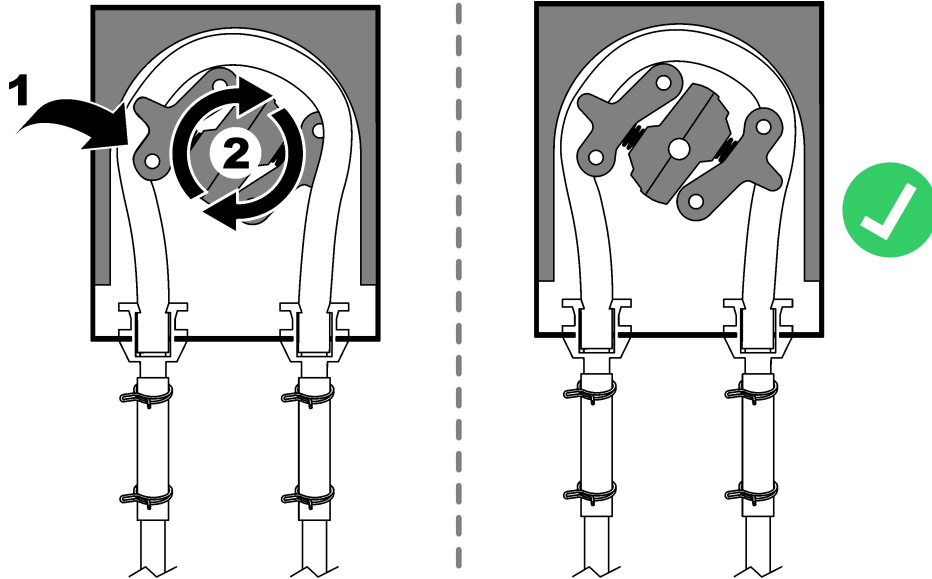

4.4.10 Install the pump tube rails

Install the pump tube rails on the pumps that do not have clear covers. Refer to the illustrated steps that follow.

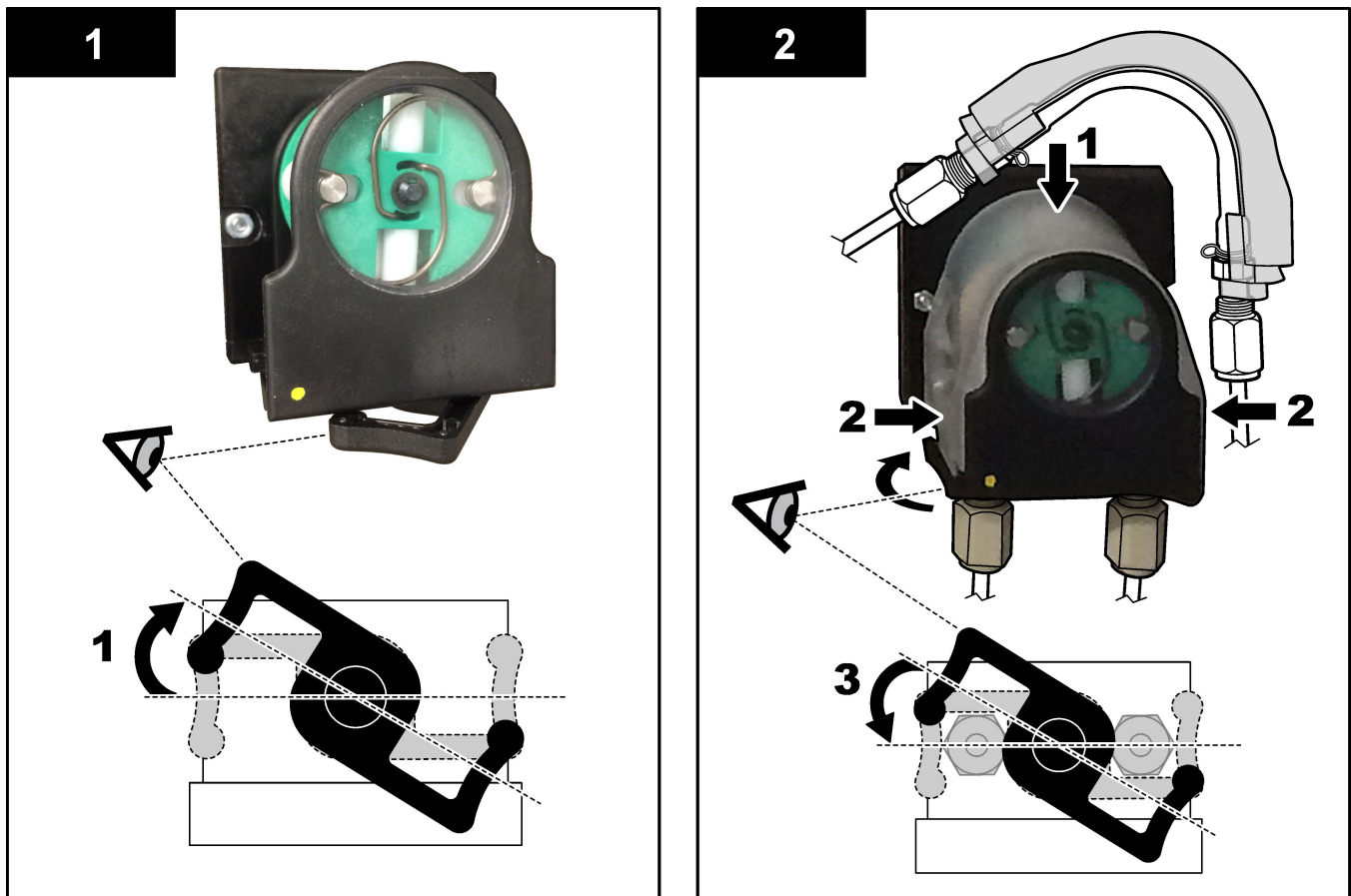

4.4.11 Connect the internal tubing

Connect the four tubes that were disconnected for shipping. The four tubes have a paper label and are attached with a zip tie to the fittings to which they should be connected.

- Connect the tube that connects the ozone generator (item 3 in Figure 17) to the acid tee (item 7), at the tee.
- Connect the tube that connects the cooler (item 2) to the CO₂ analyzer (item 6). The tube is at the top of the cooler.
- Connect the tube on the discharge side of the circulation pump (item 1).
- Connect the tube that connects the ozone destructor (item 4) to the exhaust valve (item 5). The tube is at the top of the ozone destructor.

Figure 17 Connect the disconnected tubes

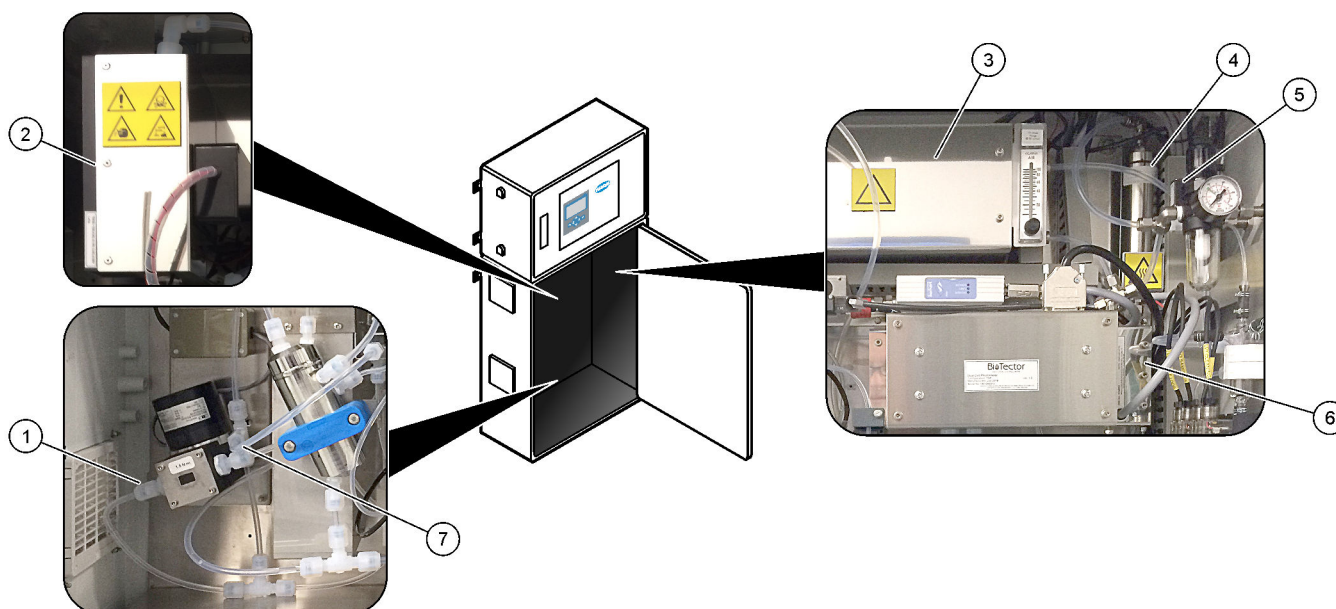

1 Circulation pump discharge tube	5 Exhaust valve
2 Cooler	6 CO ₂ analyzer
3 Ozone generator	7 Acid tee
4 Ozone destructor	

4.4.12 Connect the air purge

Connect the air purge to supply positive air pressure in the analyzer if one or more of the statements that follow are true:

- There are corrosive gasses in the area.
- The analyzer is supplied as a "purge ready" system

A "purge ready" system has a Purge Air Inlet (3/8-inch Swagelok fitting) on the left side of the analyzer and no fan.

If the analyzer is not a "purge ready" system, contact technical support to connect the air purge.

1. From the inner side of the electrical enclosure, remove the fitting blank (plug) from the Purge Air inlet.
2. Supply clean, dry instrument-quality air at 100 L/min to the Purge Air Inlet on the left side of the analyzer.

Clean, dry instrument-quality air is -20 °C dew point air that does not contain oil, water vapor, contaminants, dust or flammable vapor or gas.

3. Install a 40 micron (or smaller) air filter in the air purge line.

Additional requirements:

- Make sure that all of the purge gas supplies are made to prevent contamination.
- Make sure that the purge gas pipe has protection from mechanical damage.
- Make sure that the air compressor intake for the purge gas is in an unclassified location.
- If the compressor intake line goes through a classified location, make sure that the compressor intake line is made of noncombustible material and made to prevent leakage of flammable gases, vapors or dusts into the purge gas. Make sure that the compressor intake line has protection from mechanical damage and corrosion.

Section 5 Startup

5.1 Set the language

Set the language that shows on the display.

1. Push ✓ to go to the main menu, then select MAINTENANCE > SYSTEM CONFIGURATION > LANGUAGE.
2. Select the language, then push ✓. An asterisk (*) identifies the language selected.

5.2 Set the time and date

Set the time and date on the analyzer.

Note: When the time is changed, the analyzer may automatically start tasks that are scheduled to start before the new time setting.

1. Push ✓ to go to the main menu, then select OPERATION > TIME & DATE.
2. Select an option. Use the UP and DOWN arrow keys to change the setting.

Option	Description
CHANGE TIME	Sets the time.
CHANGE DATE	Sets the date.
DATE FORMAT	Sets the date format (e.g., DD-MM-YY).

5.3 Adjust the display brightness

Put the screen adjust tool in the "Adjust Screen Brightness" opening. Turn the screen adjust tool to set the display brightness. Refer to [Figure 18](#).

Figure 18 Adjust the display brightness

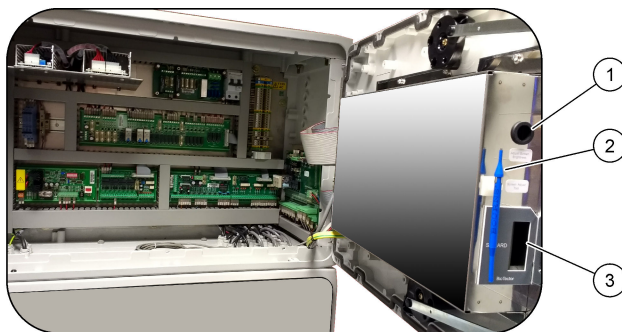

1 "Adjust Screen Brightness" opening	3 MMC/SD card slot
2 Screen adjust tool	

5.4 Examine the oxygen supply

Identify if there is CO₂ contamination in the oxygen supply as follows:

1. Set the oxygen supply to on.
2. If an oxygen concentrator is used, let the oxygen concentrator operate for a minimum of 10 minutes.
3. Select MAINTENANCE > DIAGNOSTICS > SIMULATE > OXIDATION PHASE SIM.
4. Select MFC. Set the flow to 10 L/h.
5. Push ✓ to start the mass flow controller (MFC).

6. Operate the MFC for 10 minutes. The measured CO₂ in the oxygen supply shows at the top of the display.
7. If the reading is not $\pm 0.5\%$ of the CO₂ analyzer range (e.g., ± 50 ppm CO₂ if the analyzer range is 10000 ppm), do the steps that follow:
 - a. Remove the CO₂ filter from the base reagent container.
 - b. Install the CO₂ filter in the oxygen line near the analyzer.
 - c. Do steps 4 to 6 again.

If the reading is less than before, there is CO₂ contamination in the oxygen supply. Identify if the CO₂ analyzer has dirty lenses. Identify if the CO₂ filters on the CO₂ analyzer have contamination. Identify if the CO₂ analyzer operation is correct. Use a different oxygen supply.

If the reading is not less than before, there is no CO₂ contamination in the oxygen supply.
 - d. Remove the CO₂ filter from the oxygen line.
 - e. Connect the CO₂ filter to the base reagent container.

5.5 Examine the pumps

Make sure that the pump tubes and pump tube rails are installed correctly as follows:

1. Get a small container of deionized water or tap water.
2. Disconnect the tubing from the inlet and outlet of the acid pump. Refer to [Analysis enclosure](#) on page 46.
3. Put the small container of water below the inlet of the acid pump.
4. Connect the inlet of the acid pump to the small container of water.
5. Select MAINTENANCE > DIAGNOSTICS > SIMULATE > OXIDATION PHASE SIM.
6. Select ACID PUMP.
7. Put a container below the outlet of the acid pump.
8. Select ON and operate the acid pump until water comes out of the outlet of the acid pump.
9. Select OFF to set the pump to off.
10. Put an empty graduated cylinder below the outlet of the acid pump.
11. Select ON, then enter the number of pulses identified in [Table 12](#).
12. Push to start the acid pump.
13. Wait the number of pulses identified in [Table 12](#).

1 pulse = $\frac{1}{2}$ revolution, 20 pulses = 13 seconds, 16 pulses = 8 seconds
14. Compare the volume of water in the graduated cylinder to [Table 12](#).
15. Do steps 1 to 4 and 6 to 14 again for the base pump.

Make sure that the difference in the measured volumes for the acid pump and base pump is 5% (0.2 mL) or less.
16. Do steps 1 to 4 and 6 to 14 again for the sample pump.
17. Push to go to the SIMULATE menu, then select LIQUID PHASE SIM.
18. Do steps 1 to 4 and 6 to 14 again for the remaining pumps in [Table 12](#).
19. Connect the tubing that was disconnected.

Table 12 Pump volumes



Pump	Pulses	Volume
ACID PUMP	20	3.9 to 4.9 mL
BASE PUMP	20	3.9 to 4.9 mL

Table 12 Pump volumes (continued)

Pump	Pulses	Volume
SAMPLE PUMP	16	5.5 to 7.5 mL
N PUMP	16	6.0 to 7.5 mL

5.6 Examine the valves

Make sure that the valves open and close correctly as follows:

1. Push  to go to the SIMULATE menu, then select OXIDATION PHASE SIM.
2. Select ACID VALVE on the display to open the acid valve. A sound is heard when the valve opens.
Refer to [Analysis enclosure](#) on page 46 for the locations of the valves.
3. Do step 2 again for the valves that follow:
 - BASE VALVE
 - SAMPLE VALVE ¹¹
 - INJECTION VALVE
 - SAMPLE OUT VALVE ¹²
 - EXHAUST VALVE
 - CLEANING VALVE ¹³
 - CALIBRATION VALVE
 - STREAM VALVE
 - MANUAL VALVE
4. Push  to go to the SIMULATE menu, then select LIQUID PHASE SIM.
5. Do step 2 again for the valves that follow:
 - NP SAMPLE VALVE
 - DI WATER VALVE
 - TN CLEANING VALVE

5.7 Set the reagent volumes

1. Select OPERATION > REAGENTS SETUP > INSTALL NEW REAGENTS.
2. Change the reagent levels that show on the display as necessary.
3. If the SPAN CALIBRATION or SPAN CHECK setting is set to YES on the MAINTENANCE > COMMISSIONING > NEW REAGENTS PROGRAM menu, install the calibration standard before a span calibration is started. Refer to [Plumb the calibration standard](#) on page 64.
4. Scroll down to START NEW REAGENT CYCLE, then push .
The analyzer fills all of the reagent lines with the new reagents and does a zero calibration.
In addition, if the SPAN CALIBRATION or SPAN CHECK setting is set to YES on the MAINTENANCE > COMMISSIONING > NEW REAGENTS PROGRAM menu, the analyzer does a span calibration or span check after the zero calibration.
If the CO2 LEVEL setting is set to AUTO, the analyzer sets the reaction check levels for TOC.

¹¹ Make sure that the sample (ARS) valve turns to each position. LEDs 12, 13 and 14 are on at the Signal PCB.

¹² The LED on the valve comes on when the valve is open. Make sure that the check purge valve (MV51) opens when the sample out valve opens if installed.

¹³ Look for movement of the plunger.

5.8 Analysis enclosure

Figure 19 shows the pumps and components in the analysis enclosure. Figure 20 shows the valves in the analysis enclosure.

Figure 19 Analysis enclosure—Pumps and components

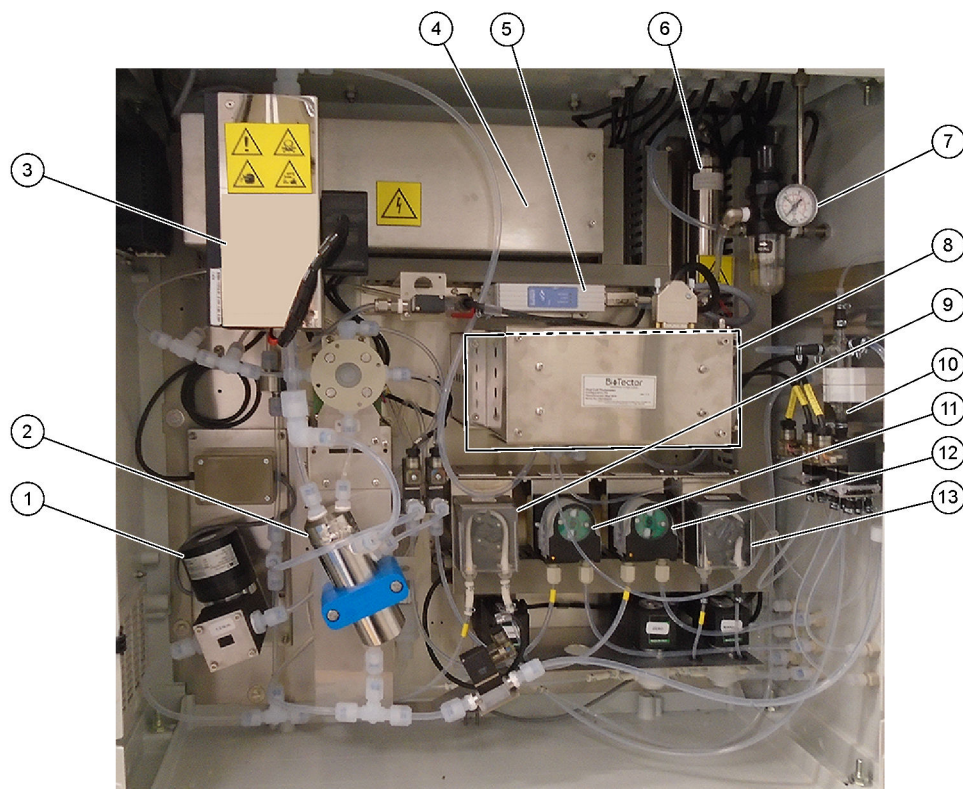

1 NF300 circulation pump, P2	8 CO ₂ analyzer
2 Reactor	9 Sample pump
3 Cooler	10 Oxidized sample catch pot/cleaning vessel
4 Ozone generator	11 Acid pump
5 Mass flow controller (MFC)	12 Base pump
6 Ozone destructor	13 Nitrogen (N) pump, LP1
7 Oxygen regulator	

Figure 20 Analysis enclosure—Valves

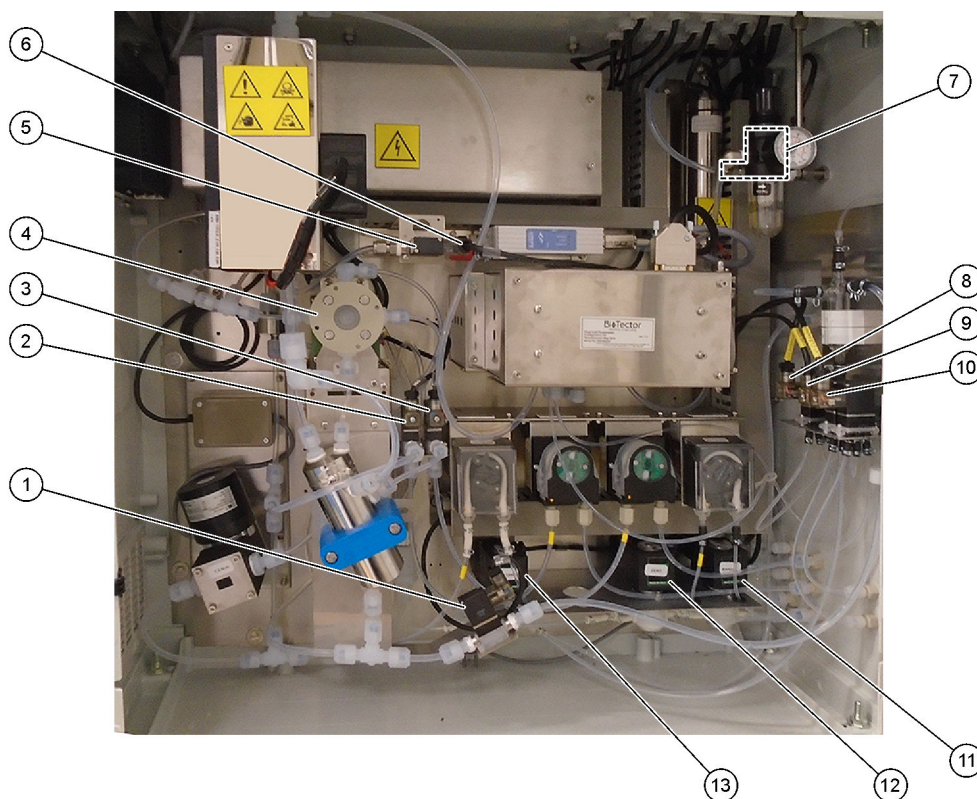

1 Sample out valve, MV5	8 NP sample valve, LV3
2 Acid valve, MV6	9 DI water valve, LV2
3 Base valve (optional)	10 TN cleaning valve, LV1
4 Sample (ARS) valve, MV4	11 Manual valve (Span Calibration valve), MV9
5 Injection valve, MV7	12 Zero water valve (Zero Calibration valve), MV15
6 Non-return valve (check valve)	13 Cleaning valve
7 Exhaust valve, MV1	

Section 6 Configuration

6.1 Set the measurement interval

Set the time between reactions to set the measurement interval.

1. Select MAINTENANCE > COMMISSIONING > REACTION TIME.
2. Select an option.

Option	Description
REACTION TIME	Shows the total reaction time (minutes and seconds) for operation range 1 (default: 9m45s). The analyzer calculates the total reaction time with the OXIDATION PROGRAM 1 settings in the SYSTEM PROGRAM menu.
INTERVAL	Sets the time between reactions. Options: 0 (default) to 1440 minutes (1 day). Note: When the analyzer automatically increases the reaction time because of a high level of TIC and/or TOC in the sample, the analyzer subtracts the added reaction time from the interval time. Note: The analyzer adjusts the INTERVAL setting if the sampler, forward and/or reverse times in the pump settings are more than the maximum time. The analyzer calculates the maximum time with the OXIDATION PROGRAM 1 settings in the SYSTEM PROGRAM menu.
TOTAL	Shows the total reaction time plus the interval time.

6.2 Set the sample pump times

Set the forward and reverse times for the sample pumps.



Note: If the forward or reverse times are more than the maximum time, the analyzer adjusts the measurement interval setting. The maximum times are based on the SYSTEM PROGRAM 1 settings.

1. Do a sample pump test for each sample stream to identify the correct forward and reverse times. Refer to [Do a sample pump test](#) on page 49.
2. Select MAINTENANCE > COMMISSIONING > SAMPLE PUMP.
The default sample pump times show for each stream (default: 45s forward, 60s reverse).
3. Enter the FORWARD time from the sample pump test.
4. Enter the REVERSE times from the sample pump test. The recommended time for REVERSE is approximately the FORWARD time plus 15 seconds.
Note: The REVERSE time for a Manual stream can only be set if an optional manual bypass valve is installed. The manual bypass valve sends the previous grab sample (or calibration standard) out the drain line.
Note: When the reverse time is not 0 (default), the self-cleaning feature is set to on and the analyzer waste exits the analyzer through the sample inlet tubing into the sample stream, which cleans the sample inlet tubing. When the reverse time is 0, the self-cleaning feature is set to off and the analyzer waste exits the analyzer through the drain line.
5. If SAMPLER times show, do not change the default setting (100 seconds) unless the default time is not sufficient for the sample chamber to fill with new sample.
If the SAMPLER time setting is changed, change the time configured in the PLC (programmable logic controller) of the sampler. Refer to the sampler user manual for instructions.
Note: SAMPLER times only show when SAMPLER is set to YES in the STREAM PROGRAM menu. Refer to [Set the stream sequence and operation range](#) on page 50.

6.2.1 Do a sample pump test

Do a sample pump test to identify the correct forward and reverse times for the sample pump for each sample stream.

1. Select MAINTENANCE > DIAGNOSTICS > PROCESS TEST > SAMPLE PUMP TEST.
2. Select an option.

Option	Description
VALVE	Sets the SAMPLE or MANUAL fitting used for the test. For example, to select the SAMPLE 1 fitting, select STREAM VALVE 1.
PUMP FORWARD TEST	<p>Starts the sample pump in the forward direction.</p> <p>Note: First select PUMP REVERSE TEST to empty the sample lines, then select PUMP FORWARD TEST.</p> <ol style="list-style-type: none"> 1. Push  to stop the timer when the sample is through the sample (ARS) valve and the sample drips into the drain pipe on the side of the analyzer. 2. Record the time on the display. The time is the correct forward time for the selected stream.
PUMP REVERSE TEST	<p>Starts the sample pump in the reverse direction.</p> <ol style="list-style-type: none"> 1. Push  to stop the timer when the sample lines and the oxidized sample catch-pot/cleaning vessel are empty. 2. Record the time on the display. The time is the correct reverse time for the sample pump.
SAMPLE PUMP	Goes to the MAINTENANCE > COMMISSIONING > SAMPLE PUMP menu to set the forward and reverse times for each sample stream.

6.3 Set the stream sequence and operation range

Set the sample stream sequence, the number of reactions to do at each sample stream and the operation range for each sample stream.

1. Select MAINTENANCE > COMMISSIONING > STREAM PROGRAM.
2. Select an option.

Option	Description
SAMPLER	Set to YES if a sampler is used with the analyzer (default: NO). When SAMPLER is set to YES (default), the sampler time shows on the SAMPLE PUMP screen.
CONTROL	<p>Set to BIOTECTOR (default) to control the stream sequence and operation ranges with the analyzer.</p> <p>Set to EXTERNAL to control the stream sequence and operation ranges with an external device (e.g., Modbus master).</p>
START-UP RANGE	<p>Note: The START-UP RANGE setting is available when CONTROL is set to BIOTECTOR and the first operation range setting for a stream is set to AUTO.</p> <p>Sets the operation range used for the first reaction when the analyzer starts (default: 3).</p>
RANGE LOCKED	<p>Note: The RANGE LOCKED setting is available if one or more of the RANGE settings for the stream sequence is set to AUTO.</p> <p>Sets the operation range to change automatically (NO, default) or to stay at the START-UP RANGE setting (YES).</p>

Option	Description
PROGRAMMED STREAMS	Shows the number of streams installed and configured.
STREAM x, x RANGE x	<p>Note: If CONTROL is set to EXTERNAL, an external device (e.g., Modbus master) controls the stream sequence and operation ranges.</p> <p>Sets the number of reactions and the operation range for each stream.</p> <p>STREAM —The first setting is the stream valve number. The second setting is the number of reactions done at the sample stream before the analyzer does reactions with the next sample stream. When STREAM is set to “- , -” and RANGE is set to “-“, the stream is not measured.</p> <p>RANGE —Sets the operation range for each sample stream. Options: 1, 2, 3 (default) or AUTO. Select OPERATION > SYSTEM RANGE DATA to see the operation ranges.</p> <p>Note: The AUTO (automatic) range option is disabled in analyzers with more than one stream.</p>

6.4 Configure the COD and BOD settings

Set the analyzer to show COD and/or BOD information on the Reaction Data screen as necessary. Set the values used to calculate the COD and/or BOD results.

1. Select MAINTENANCE > COMMISSIONING > COD/BOD PROGRAM.
2. Select COD PROGRAM or BOD PROGRAM.
3. Select an option.

Option	Description
DISPLAY	Sets the analyzer to show COD and/or BOD information on the Reaction Data screen and show the COD and/or BOD (mgO/L) results on a 4–20 mA output if configured (default: ----).
STREAM 1–6	<p>The first setting is the overall factor (default: 1.000). Refer to the equation that follows. The second setting is the offset factor (default: 0.000). The stream factors for each stream come from the procedures in the information sheet <i>1030. TOC to COD or BOD Correlation Method</i>. STREAM 1 factors are used for manual samples and calibration standards.</p> <p>$\text{COD (and/or BOD)} = \text{Overall factor} \times \{ (\text{TOC FACTOR} \times \text{TOC}) + [\text{TN FACTOR} \times (\text{TN} - \text{NO}_3 \text{ ESTIMATE})] \} + \text{Offset factor}$</p>
TOC FACTOR	<p>Sets the TOC FACTOR (default: 1.000).</p> <p>Note: In TC analysis mode, TC FACTOR shows on the display and is used in the equation as an alternative to the TOC FACTOR.</p>
TN FACTOR	Sets the TN FACTOR (default: 1.000).
NO3 ESTIMATE	Sets the NO3 ESTIMATE. If the NO3 ESTIMATE setting is more than the TN result, the TN result is not included in the calculation (default: 0.0 mgN/L).

6.5 Configure the install new reagents settings

Configure the analyzer options for the OPERATION > REAGENTS SETUP > INSTALL NEW REAGENTS function.

1. Select MAINTENANCE > COMMISSIONING > NEW REAGENTS PROGRAM.
2. Select an option.

Option	Description
SPAN CALIBRATION	Sets the analyzer to do a span calibration during the INSTALL NEW REAGENTS cycle (default: NO). Refer to Start a span calibration or span check on page 63 for the span calibration function. If set to YES, make sure to install the calibration standard before a span calibration is started. Refer to Plumb the calibration standard on page 64.
SPAN CHECK	Note: <i>It is not possible to set SPAN CALIBRATION and SPAN CHECK to YES.</i> Sets the analyzer to do a span check during the INSTALL NEW REAGENTS cycle (default: NO). Refer to Start a span calibration or span check on page 63 for the span check function. If set to YES, make sure to install the calibration standard before a span check is started. Refer to Plumb the calibration standard on page 64.
AUTOMATIC RE-START	Set the analyzer to go to back to operation when the INSTALL NEW REAGENTS cycle is completed (default: YES).

6.6 Set reagent monitoring

Configure the alarm settings for low reagents and no reagents. Set the reagent volumes.

1. Select MAINTENANCE > COMMISSIONING > REAGENTS MONITOR.
2. Select an option.

Option	Description
REAGENTS MONITOR	Sets the Reagent Status screen to show on the display (default: YES).
LOW REAGENTS	Sets the low reagents alarm as a notification or a warning. Options: NOTE (default) or WARNING
LOW REAGENTS AT	Sets the number of days before the reagent containers are empty when a 85_LOW REAGENTS alarm should occur (default:). Note: <i>The analyzer calculates the number of days before the reagent containers are empty.</i>
NO REAGENTS	Sets the no reagents alarm as a notification, warning or a fault. NOTE —A relay for notifications is set to on when a no reagents alarm occurs if configured. WARNING (default)—A relay for warning events is set to on and a 20_NO REAGENTS warning occurs if configured. FAULT —The fault relay is set to on, measurements stop and a 20_NO REAGENTS fault occurs.
ACID VOLUME	Sets the volume (liters) of the acid reagent in the reagent container.
BASE VOLUME	Sets the volume (liters) of the base reagent in the reagent container.
TN CLEANING VOLUME	Sets the volume (liters) of the TN cleaning solution in the reagent container.
DI WATER VOLUME	Sets the volume (liters) of the TN DI water in the reagent container.

6.7 Configure the analog outputs

Set what is shown on each 4–20 mA output, the full scale range of each 4–20 mA output and when each 4–20 mA output changes. Set the fault level for the 4–20 mA outputs.

After the analog outputs are configured, do a 4–20 mA output test to make sure that the correct signals are received by the external device. Refer to the instructions in the Maintenance and Troubleshooting manual.

1. Select MAINTENANCE > COMMISSIONING > 4-20mA PROGRAM.
2. Select OUTPUT MODE.
3. Select an option.
 - **DIRECT** (default)—Refer to [Table 13](#) to configure the settings. Configure each channel (4–20 mA output) to show a specified stream (STREAM 1) and result type (e.g., TOC).
 - **STREAM MUX**—Refer to [Table 14](#) to configure the settings. The CHANNEL 1 setting cannot be changed. Configure Channels 2 to 6 (4–20 mA Outputs 2 to 6) to each show one result type (e.g., TOC). The 4–20 mA outputs can show a maximum of 35 results. Refer to *4–20 mA output modes* in the Advanced Configuration Manual for more information.
 - **FULL MUX**—Refer to [Table 15](#) to configure the settings. The CHANNEL 1–4 settings cannot be changed. No other channels are used. The 4–20 mA outputs can show a maximum of 35 results. Refer to *4–20 mA output modes* in the Advanced Configuration Manual for more information.

Table 13 Direct mode settings

Option	Description
CHANNEL 1–6	<p>Sets what is shown on the 4–20 mA Outputs 1–6 (Channel 1–6), the full scale range of each 4–20 mA output and when each 4–20 mA output changes.</p> <p>First setting—Sets what the 4–20 mA output shows.</p> <ul style="list-style-type: none"> • STREAM # (default)—Shows the selected sample stream (e.g., STREAM 1). • MANUAL #—Shows the selected manual grab sample (e.g., MANUAL 1). • CAL —Shows the zero and span calibration results. • CAL ZERO —Shows the zero calibration results. • CAL SPAN —Shows the span calibration results. <p>Second setting—Sets the result type. Options: TOC, TIC, TC, VOC, COD, BOD or TN. In TIC + TOC analysis mode, TC is the sum of TIC and TOC.</p> <p>Third setting—Sets the result that the output shows as 20 mA (e.g., 1000mgC/L). The output shows 4 mA for 0 mgC/L.</p> <p>Fourth setting—Sets when the outputs change.</p> <ul style="list-style-type: none"> • INST —The output changes at the end of each reaction. • AVRG —The output (average result of the last 24 hours) changes at the AVERAGE UPDATE time selected in SYSTEM CONFIGURATION > SEQUENCE PROGRAM > AVERAGE PROGRAM. <p><i>Note: The 4–20 mA outputs that show calibration results change when the system completes the number of calibration reactions set in MAINTENANCE > SYSTEM CONFIGURATION > SEQUENCE PROGRAM > ZERO PROGRAM or SPAN PROGRAM.</i></p>
SIGNAL FAULT	<p>Sets all of the 4–20 mA outputs to change to the FAULT LEVEL setting when a fault occurs.</p> <p>YES (default)—All of the 4–20 mA outputs change to the FAULT LEVEL setting when a fault occurs.</p> <p>NO—The 4–20 mA outputs continue to show the results when a fault occurs.</p>

Configuration

Table 13 Direct mode settings (continued)

Option	Description
FAULT LEVEL	Sets the fault level (default: 1.0 mA).
OUTPUT < 4mA	<p>Sets the percentage applied to the result shown at the output if the output value is less than 4 mA, which is a negative result (default: 0%).</p> <p>For example, if the OUTPUT setting is 100%, the analyzer sends 100% of the negative result as the 4–20 mA signal. If the OUTPUT setting is 50%, the analyzer sends 50% of the negative result as the 4–20 mA signal. When the OUTPUT setting is 0%, the analyzer does not send a negative result. The analyzer shows a negative result as 4 mA (0 mgC/L).</p>

Table 14 Stream multiplex mode settings

Option	Description
CHANNEL 1–6	<p>Sets the result type that shows on the 4–20 mA outputs (Channels 1–6). Options: TC, VOC, COD, BOD, TIC, TOC or TN. The Channel 1 setting cannot be changed.</p> <p><i>Note: The CHANNEL # and OUTPUT # settings identify what Channels 2 to 6 show. Refer to the OUTPUT option description for more information.</i></p>
OUTPUT PERIOD	<p>Sets the time to show a full set of reaction results (results sequence) on the 4–20 mA outputs plus the idle time before the next results sequence starts (default: 600s).</p> <p>If a new result is available during the idle period, the results sequence starts. The idle period is not completed.</p> <p>If a new result is available before a results sequence is completed, the analyzer shows the new result then continues the result sequence.</p> <p>Make sure that OUTPUT PERIOD is sufficient to complete a results sequence. Use the formulas that follow to calculate the minimum OUTPUT PERIOD:</p> <ul style="list-style-type: none"> • Stream multiplex mode—OUTPUT PERIOD = [2 x (SIGNAL HOLD TIME) + 1 second] x [number of streams] • Full multiplex mode—OUTPUT PERIOD = {[2 x (SIGNAL HOLD TIME) + 1 second] x (number of result types)} x [number of streams]
SIGNAL HOLD TIME	<p>Sets the amount of time that Channel 1 holds a signal before Channel 1 goes to 4 mA (change level) or to the next stream identification level (e.g., 6 mA = STREAM 2). Default: 10s</p> <p>When the SIGNAL HOLD TIME setting is 10 seconds, Channels 2 to 6 hold their signal for 20 seconds (2 x SIGNAL HOLD TIME).</p>
SIGNAL FAULT	Refer to SIGNAL FAULT in Table 13 .
FAULT LEVEL	Refer to FAULT LEVEL in Table 13 .
OUTPUT < 4mA	Refer to OUTPUT < 4mA in Table 13 .
OUTPUT 1–35	<p>Sets what is shown on the 4–20 mA outputs (Channels 2 to 6), the full scale value of each 4–20 mA output and when each 4–20 mA output changes.</p> <p>The result type in the OUTPUT setting (e.g., TOC) identifies the channel (Channel 2 to 6) on which the result shows. For example, if CHANNEL 3 is set to TOC and the OUTPUT 1 setting has a result type of TOC, the result identified in the OUTPUT 1 setting shows on Channel 3. If OUTPUT 1 is set to STREAM 1, TOC, 1000 mgC/L and INST, when the Channel 1 signal identifies STREAM 1, Channel 3 shows the TOC result where 1000 mgC/L is shown as 20 mA.</p> <p>Refer to CHANNEL in Table 13 for descriptions of the four settings for each OUTPUT setting.</p>

Table 15 Full multiplex mode settings

Option	Description
CHANNEL 1–4	<p>The CHANNEL 1–4 settings cannot be changed.</p> <p><i>Note: The OUTPUT # settings identify what Channels 3 and 4 show.</i></p>
OUTPUT PERIOD	Refer to OUTPUT PERIOD in Table 14 .

Table 15 Full multiplex mode settings (continued)

Option	Description
SIGNAL HOLD TIME	Sets how the long Channel 1 and 2 hold their signal before the channels go to 4 mA (change level or not defined level) or to the next stream identification level or result type level. Default: 10s When the SIGNAL HOLD TIME setting is 10 seconds, Channel 3 holds the signal for 20 seconds (2 x SIGNAL HOLD TIME).
SIGNAL FAULT	Refer to SIGNAL FAULT in Table 13 .
FAULT LEVEL	Refer to FAULT LEVEL in Table 13 .
OUTPUT < 4mA	Refer to OUTPUT < 4mA in Table 13 .
OUTPUT 1–35	Sets what is shown on the 4–20 mA outputs (Channels 3 and 4), the full scale value of each 4–20 mA output and when each 4–20 mA output changes. The result type in the OUTPUT setting (e.g., TOC) identifies the channel on which the result shows. For example, if CHANNEL 3 is set to TOC and the OUTPUT 1 setting has a result type of TOC, the result identified in the OUTPUT 1 setting shows on Channel 3. If OUTPUT 1 is set to STREAM 1, TOC, 1000 mgC/L and INST, when the Channel 1 signal identifies STREAM 1, Channel 3 shows the TOC result where 1000 mgC/L is shown as 20 mA. Refer to CHANNEL in Table 13 for descriptions of the four settings for each OUTPUT setting.

6.8 Configure the relays

Configure the relay idle conditions and the conditions that set the relays to on. After the relays are configured, do a relay test to make sure that the relays operate correctly. Refer to the instructions in the Maintenance and Troubleshooting manual.

1. Select MAINTENANCE > SYSTEM CONFIGURATION > OUTPUT DEVICES.
2. Select an option.

Option	Description
RELAY 18–20	Sets the condition(s) that set RELAY 18 and RELAY 19 to on. Refer to Table 16 . <i>Note: Relay 20 is not configurable. Relay 20 is the fault relay.</i>
POWERED ALL TIME	When RELAY 18 or 19 is set to STREAM, sets the relay to on all of the time (YES) or set to on only when necessary (NO, default), such as when the sample pump operates in forward or reverse.
OUTPUT 1–8	Sets the conditions that set Outputs 1–8 to on. Refer to Table 16 to configure Outputs 1–8.

Table 16 RELAY settings

Setting	Description	Setting	Description
---	No setting	CAL	The relay is set to on when the calibration valve opens.
STREAM 1–6	The relay is set to on when a stream valve opens.	ALARM	The relay is set to on when a selected alarm condition occurs. The alarm conditions are set on the RELAY PROGRAM screen. Refer to step 3 that follows.
STM ALARM 1–6	The relay is set to on when a stream alarm occurs.	SYNC	The relay is set to a synchronization relay. A synchronization relay is used to synchronize the analyzer with external control devices.

Table 16 RELAY settings (continued)

Setting	Description	Setting	Description
MANUAL 1–6	The relay is set to on when a manual valve opens.	MAN MODE TRIG	The relay is set to on when manual reactions (grab sample measurements) are started at the keyboard or with the Manual-AT Line option. <i>Note: The Manual-AT Line option is a small box with only a green button. The Manual-AT Line cable is connected to the analyzer.</i>
FAULT	The relay is set to on when a system fault occurs (normally energized relay).	4-20mA CHNG	The relay is set to a 4–20 mA change flag relay. The relay is set to on for a period of 10 seconds when a new result on any sample stream causes an analog output value to change.
WARNING	The relay is set to on when a warning occurs (normally energized relay).	4-20mA CHNG 1–6	The relay is set to a 4–20 mA change flag relay for a specific sample stream (1–6). The relay is set to on for a period of 10 seconds when a new result on the sample stream causes an analog output value to change.
FAULT OR WARN	The relay is set to on when a fault or warning occurs (normally energized relay).	4-20mA READ	The relay is set to on when the 4–20 mA outputs are set to stream multiplex or full multiplex mode and there are valid/stable values on the 4–20 mA outputs.
NOTE	The relay is set to on when a notification is saved to the fault archive.	SAMPLER FILL	The relay is set to on when from the start of the sampler fill time to the completion of the sample injection. The relay controls the sampler.
STOP	The relay is set to on when the analyzer is stopped. <i>Note: Remote standby does not set the relay to on.</i>	SAMPLER EMPTY	The relay is set to on for 5 seconds after the sample pump reverse operation is complete. The relay controls the sampler.
MAINT SIGNAL	The relay is set to on when the maintenance switch (Input 22) is set to on.	SAMPLE STATUS	The relay is set to on when there is no sample or the sample quality is less than 75% (default). For example, when there are a lot of air bubbles in the stream/manual grab sample lines.
CAL SIGNAL	The relay is set to on when a zero or span calibration, or a zero or span check starts.	SAMPLE FAULT 1	The relay is set to on when the external SAMPLE FAULT 1 input signal is activated.
REMOTE STANDBY	The relay is set to on when the remote standby switch (digital input) is set to on.	SAMPLER ERROR	The relay is set to on when a BioTector sampler error occurs.
TEMP SWITCH	The relay is set to on when the temperature switch of the analyzer sets the fan to on (default: 25 °C).	CO2 ALARM	The relay is set to on when a CO2 ALARM occurs.

3. Select MAINTENANCE > COMMISSIONING > RELAY PROGRAM.

4. Select and configure each option as applicable.

Option	Description
COMMON FAULT	<p>Sets the idle condition of the fault relay (Relay 20) and the condition that sets the fault relay to on.</p> <p>First setting—Sets the idle condition of the fault relay. N/E (default)—Normally energized, closed (default). N/D—Normally de-energized, open.</p> <p>Second setting—Sets the condition that sets the fault relay to on. STOP/FAULT (default)—The relay is set to on when a system fault occurs or the analyzer is stopped. FAULT ONLY—The relay is set to on when a system fault occurs.</p> <p><i>Note: The relay changes back to the idle condition when the system fault is acknowledged.</i></p>
ALARM	<p><i>Note: The ALARM setting only shows when ALARM is selected in the RELAY setting on the OUTPUT DEVICES screen.</i></p> <p>Sets the idle condition of the alarm relay and the condition that sets an alarm relay to on.</p> <p>First setting—Sets the idle condition of the alarm relay. N/E—Normally energized, closed (default). N/D (default)—Normally de-energized, open.</p> <p>Second setting—Sets the minimum concentration (e.g., 250.0 mgC/L) that sets the alarm relay to on at the end of a reaction for any of the sample streams.</p> <p><i>Note: For the TIC + TOC and VOC analysis types, the TOC results of the last completed reaction control the alarm relays. For the TC analysis type, the TC results control the alarm relays.</i></p>
CO2 ALARM	<p><i>Note: The CO2 ALARM setting only shows when STM ALARM is selected in the RELAY setting on the OUTPUT DEVICES screen.</i></p> <p><i>Note: Only use the CO2 ALARM settings with multi-stream systems that operate on fixed operation ranges, or systems that operate on a single operation range. Do not use the CO2 ALARM setting with an analyzer that uses automatic range change.</i></p> <p>Sets the CO₂ peak value that sets the CO₂ ALARM relay to on. The default is 10000.0 ppm. Carefully select the CO₂ peak value. Think about the temperature effect, which could have a important effect on the CO₂ peaks. To disable the alarm relay, select 0.0 ppm.</p> <p>The CO₂ alarm identifies a possible high TOC (COD and/or BOD if programmed) level. The CO₂ alarm supplies a warning of an unusually high TOC result from the rising slope of the CO₂ peak during a reaction.</p> <p><i>Note: In TIC + TOC and VOC analysis types, the CO₂ peak used for the CO₂ alarm is the TOC CO₂ peak. In the TC analysis type, the CO₂ peak used for the CO₂ alarm is the TC CO₂ peak.</i></p>
STM ALARM 1–6	<p><i>Note: The STM ALARM setting only shows when STM ALARM 1–6 is selected in the RELAY setting on the OUTPUT DEVICES screen.</i></p> <p>Sets the sample stream (e.g., STREAM 1) and result type that sets a stream alarm relay to on. The result type options are TOC, TIC, TC, VOC, COD, BOD or TN.</p> <p>First setting—Sets the result type that sets a stream alarm relay to on. The result type options are TOC, TIC, TC, VOC, COD, BOD or TN.</p> <p>Second setting—Sets the sample stream (e.g., STREAM 1).</p> <p>Third setting—Sets the idle condition for the stream alarm relay. N/E—Normally energized, closed (default). N/D (default)—Normally de-energized, open.</p> <p>Fourth setting—Sets the minimum concentration (e.g., 1000.0 mgC/L) that sets the stream alarm relay to on at the end of each reaction for the specific sample stream.</p>

6.9 Configure the communication settings

Configure the communication settings for the output devices: MMC/SD card and/or Modbus.

Note: Analyzer communication with a printer or Windows PC is no longer available.

1. Select MAINTENANCE > COMMISSIONING > DATA PROGRAM.
2. Select MMC/SD CARD.
3. Select an option.

Option	Description
PRINT MODE	<p>Sets the type of data sent to the MMC/SD card. Options: STANDARD or ENGINEERING (default).</p> <p>Refer to Table 21 on page 74 and Table 22 on page 74 for descriptions of the reaction data sent when STANDARD or ENGINEERING is selected.</p> <p>Note: The manufacturer recommends that PRINT MODE is set to ENGINEERING so that troubleshooting data is saved.</p>
REACTION ON-LINE	No longer used. Sends the reaction data to the printer at the end of each reaction (default: NO).
FAULT ON-LINE	No longer used. Sends the faults and warnings to the printer when a fault or warning occurs (default: NO).
CONTROL CHARS	Sends the control characters with the Modbus RS232 data (default: NO).
BAUDRATE	No longer used. Sets the data communication baudrate for the printer or Windows PC (default: 9600). Options: 2400 to 115200
FLOW CONTROL	No longer used. Sets how the analyzer controls the flow of data between the analyzer and the printer or Windows PC. NONE (default)—No control. XON/XOFF —XON/XOFF control. LPS1/10 —1 to 10 lines of data sent each second.
DECIMAL	Sets the type of decimal point included in the reaction data sent to the MMC/SD card (default: POINT). Options: POINT (.) or COMMA (,)

6.10 Configure the Modbus TCP/IP settings

If the optional Modbus TCP/IP module is installed in the analyzer, configure the Modbus settings.

Note: The Modbus register maps are supplied in the Advanced Configuration Manual.

1. Select MAINTENANCE > COMMISSIONING > MODBUS PROGRAM.
2. Select an option.

Option	Description
MODE	Shows the Modbus operating mode: BIOTECTOR. The MODE setting cannot be changed.
BAUDRATE	<p>Sets the Modbus baudrate for the instrument and the Modbus master device (1200 to 115200 bps, default: 57600).</p> <p>Note: For Modbus TCP/IP, do not change the BAUDRATE setting. The RTU-to-TCP converter uses the default BAUDRATE setting.</p>
PARITY	<p>Sets the parity to NONE (default), EVEN, ODD, MARK or SPACE.</p> <p>Note: For Modbus TCP/IP, do not change the PARITY setting. The RTU-to-TCP converter uses the default PARITY setting.</p>

Option	Description
DEVICE BUS ADDRESS	Sets the Modbus address of the instrument (0 to 247, default: 1). Enter a fixed address that a Modbus protocol message cannot change. If DEVICE BUS ADDRESS is set to 0, the analyzer will not communicate with the Modbus Master.
MANUFACTURE ID	Sets the manufacturer ID of the instrument (default: 1 for Hach).
DEVICE ID	(Optional) Sets the class or family of the instrument (default: 1234).
SERIAL NUMBER	Sets the serial number of the instrument. Enter the serial number that is on the instrument.
LOCATION TAG	Sets the location of the instrument. Enter the country where the instrument is installed.
FIRMWARE REV	Shows the firmware revision installed on the instrument.
REGISTERS MAP REV	Shows the Modbus register map version used by the instrument. Refer to the Modbus register maps in the Advanced Configuration Manual.

6.11 Save the settings to memory

Save the analyzer settings to internal memory or an MMC/SD card. Then install the saved settings on the analyzer as necessary (e.g., after a software update or to go back to the previous settings).

1. Select MAINTENANCE > SYSTEM CONFIGURATION > SOFTWARE UPDATE.
2. Select an option.

Option	Description
LOAD FACTORY CONFIG	Installs the analyzer settings saved to internal memory with the SAVE FACTORY CONFIG option.
SAVE FACTORY CONFIG	Saves the analyzer settings to internal memory.
LOAD CONFIG FROM MMC/SD CARD	Installs the analyzer settings from the MMC/SD card with the SAVE CONFIG TO MMC/SD CARD option. Note: Use this option to go back to the previous settings or install the settings after a software update.
SAVE CONFIG TO MMC/SD CARD	Saves the analyzer settings to the syscnfg.bin file on the MMC/SD card. Note: The MMC/SD card supplied with the analyzer contains the factory default settings in the syscnfg.bin file.
UPDATE SYSTEM SOFTWARE	Installs a software update. Contact the manufacturer or distributor for the software update procedure.

6.12 Set security passwords for menus

Set a four-digit password (0001 to 9999) to restrict access to a menu level as necessary. Set a password for one or more of the menu levels that follows:

- OPERATION
- CALIBRATION
- DIAGNOSTICS
- COMMISSIONING
- SYSTEM CONFIGURATION

1. Select MAINTENANCE > SYSTEM CONFIGURATION > PASSWORD.
2. Select a menu level, then enter a 4-digit password.

Note: When a password is set to 0000 (default), the password is disabled.

6.13 Show the software version and serial number

Show the contact information for technical support, the software version or the serial number of the analyzer.

1. Select MAINTENANCE > COMMISSIONING > INFORMATION.
2. Select an option.

Option	Description
CONTACT INFORMATION	Shows the contact information for technical support.
SOFTWARE	Shows the software version installed on the analyzer. Shows the date the software version was released.
IDENTIFICATION	Shows the serial number of the analyzer.

Section 7 Calibration

7.1 Start a zero calibration or zero check

Start a zero calibration after a maintenance task or after reagent replacement or addition. After maintenance, measure water ten times before a zero calibration is done to remove contamination from the analyzer.

A zero calibration sets the zero offset values. Start a zero check to see if the zero offset values set by the analyzer are correct as necessary.

The zero adjust values remove the effect that the items that follow can have on measurement results:

- Contamination in the analyzer
- Organic carbon and nitrogen contamination in the acid reagent and base reagent
- Absorbed CO₂ in the base reagent

1. Select CALIBRATION > ZERO CALIBRATION.
2. Select an option.

Option	Description
TOC ZERO ADJUST TN ZERO ADJUST	(Optional) Sets the zero adjust values for zero calibrations manually for each range (1, 2 and 3) and each parameter. When the zero adjust values are entered manually, the analyzer records the information in the reaction archive with the prefix "ZM" (zero manual). <i>Note: The TOC zero adjust values are the zero offset values in mgC/L measured by the CO₂ analyzer. The TN zero adjust value is the zero offset absorbance value measured by the dual cell photometer.</i>
RUN REAGENTS PURGE	Starts a reagent purge cycle, which primes the reagents in the analyzer. <i>Note: To change the pump operation time for the reagent purge cycle, select MAINTENANCE > SYSTEM CONFIGURATION > SEQUENCE PROGRAM > REAGENTS PURGE.</i>
RUN ZERO CALIBRATION	Starts a zero calibration, which sets the zero adjust values automatically for each range (1, 2 and 3) for each parameter. Zero calibration reactions have the prefix "ZC". Stop measurements before a zero calibration is started. <i>Note: A zero calibration reaction is the same as a normal reaction, but the zero water is measured and the sample pump does not operate in the reverse direction.</i> Make sure to plumb deionized water (< 5 ppb TOC) to the ZERO WATER fitting before a zero calibration is started. <i>Note: Approximately 500 to 800 mL of deionized water is used for a zero calibration or zero check.</i>

At the end of a zero calibration, the analyzer does the actions that follow:

- **TOC zero adjust value**—The analyzer uses the uncalibrated TOC measurement (not the results that show on the display) to calculate and set new zero adjust values.
- **TN zero adjust value**—The analyzer uses the uncalibrated TN absorbance data (not the results that show on the display) to calculate and set a new zero adjust value.
- **CO₂ LEVEL setting**—The analyzer sets the CO₂ LEVEL setting to AUTO (automatic) on the REACTION CHECK screen. Then a new reaction check CO₂ level is saved.
- **CO₂ level**—The analyzer compares the CO₂ level to the BASE CO₂ ALARM setting in the FAULT SETUP menu. If the measured CO₂ level is more than the BASE CO₂ ALARM value, a 52_HIGH CO₂ IN BASE warning occurs.

Option	Description
RUN ZERO CHECK	<p>Starts a zero check. A zero check is the same as a zero calibration, but the analyzer does not change of the zero adjust values or the CO₂ LEVEL settings. Zero check reactions have the prefix "ZK". Stop measurements before a zero check is started.</p> <p>Make sure to plumb deionized water to the ZERO WATER fitting before a zero check is started.</p> <p>At the end of a zero check, the analyzer does the actions that follow:</p> <ul style="list-style-type: none"> The analyzer identifies the zero response at each range and shows the suggested zero adjust values in brackets "[]" near the zero adjust values set by the analyzer. <i>Note: Manually change the zero adjust value settings on the RUN ZERO CHECK screen if necessary.</i> The analyzer compares the CO₂ level to the BASE CO₂ ALARM setting in the FAULT SETUP menu. If the measured CO₂ level is more than the BASE CO₂ ALARM value, a 52_HIGH CO₂ IN BASE warning occurs.
ZERO PROGRAM	<p><i>Note: Do not change the default setting unless necessary. Changes can have a negative effect on the zero adjust values.</i></p> <p>Sets the number of zero reactions done during a zero calibration or zero check for each operation range (R1, R2 and R3).</p> <p><i>Note: The analyzer does not do a zero reaction for the operation ranges set to 0. The analyzer calculates the zero adjust values for the operation ranges set to 0.</i></p>
ZERO AVERAGE	<p><i>Note: Do not change the default setting unless necessary. Changes can have a negative effect on the zero adjust values.</i></p> <p>Sets the number of zero reactions averaged for each operation range at the end of the zero cycles for all of the measured parameters.</p>

7.1.1 Measure deionized water

Measure deionized water five times to make sure that the zero calibration is correct as follows:

1. Connect deionized water to the MANUAL fitting.
2. Set the analyzer to do five reactions at operation range 1. Refer to [Measure a grab sample](#) on page 71.
If the results of the measurements are almost 0 mgC/L CO₂, the zero calibration is correct.
3. If the results of the measurements are not almost 0 mgC/L CO₂, do the steps that follow:
 - a. Do a pH test. Use deionized water for the sample. Refer to *Do a pH test* in the Maintenance and Troubleshooting Manual.
 - b. Measure the TIC pH. Make sure that the TIC pH is less than 2.
 - c. Measure the BASE pH. Make sure that the BASE pH is more than 12.
 - d. Measure the TOC pH. Make sure that the TOC pH is less than 2.
 - e. Measure the deionized water two more times. Refer to step 2.
 - f. Do the steps in [Set the reagent volumes](#) on page 45 again.

7.2 Start a span calibration or span check

Set the operation range and the calibration standards for span calibrations. Start a span calibration to set the span adjust values, which adjust the measurement results. Start a span check to identify if the span adjust values saved to the analyzer are correct.

1. Select CALIBRATION > SPAN CALIBRATION.
2. Select an option.

Option	Description
TIC SPAN ADJUST	(Optional) Sets the TIC, TOC and TN span adjust values for span calibrations manually for each range.
TOC SPAN ADJUST	STANDARD —Enter the calibration standard (mg/L) and the calibrated average reaction result for each range (1, 2 and 3).
TN SPAN ADJUST	RESULT —Enter the result of the calibrated average reaction for each range (1, 2 and 3). The analyzer uses the STANDARD and RESULT values to calculate the span adjust values of each parameter for each range. Note: To set the span adjust values to 1.00, enter 0.0 for STANDARD and RESULT.
RUN SPAN CALIBRATION	Starts a span calibration, which sets the span adjust values automatically. Span calibration reactions have the prefix of “SC”. Make sure that measurements are stopped before a span calibration is started. Make sure to install the calibration standard before a span calibration is started. Refer to Plumb the calibration standard on page 64. Note: The analyzer uses the same span adjust value calculated for the selected RANGE for the other ranges, unless the span adjust values are manually changed. A span calibration reaction is the same as a normal reaction, but the prepared calibration standard is measured and the sample pump does not operate in reverse.
RUN SPAN CHECK	Starts a span check. A span check is the same as a span calibration, but the analyzer does not change the span adjust values. Span check reactions have the prefix “SK”. Stop measurements before a span check is started. Make sure to install the calibration standard before a span check is started. Refer to Plumb the calibration standard on page 64. At the end of a span check, the analyzer identifies the span response at each range and shows the suggested span adjust values in brackets “[]” near the span adjust values set by the analyzer. Note: Manually change the span adjust value settings on the RUN SPAN CHECK screen if necessary.
SPAN PROGRAM	Note: Do not change the default setting unless necessary. Changes can have a negative effect on the span adjust values. Sets the number of span reactions done during a span calibration and a span check (default: 6).
SPAN AVERAGE	Note: Do not change the default setting unless necessary. Changes can have a negative effect on the span adjust values. Sets the number of reactions the analyzer uses to calculate the average value used for the span adjust values (default: 3).

Option	Description
RANGE	<p>Sets the operation range for span calibration reactions and span check reactions (default: 1). Select the operation range that agrees with normal measurements for the sample stream(s).</p> <p>Refer to the System Range Data screen to see the operation ranges. Select OPERATION > SYSTEM RANGE DATA.</p> <p>Note: If the RANGE setting is not applicable to the TIC, TOC and TN STANDARD setting, the analyzer shows "CAUTION! REACTION RANGE OR STANDARD IS INCORRECT".</p>
TIC STANDARD	<p>Sets the concentrations of the TIC, TOC and TN calibration standards for span calibrations.</p> <p>Enter concentrations that are more than 50% of the full scale value for the operation range selected in the RANGE setting. For example, if the operation range for TIC or TOC is 0 to 250 mgC/L, 50% of the full scale value is 125 mgC/L.</p> <p>If a calibration standard selected is 0.0 mgC/L, the analyzer does not change the span adjust value for that parameter.</p>
TOC STANDARD	
TN STANDARD	

7.3 Plumb the calibration standard

Plumb the calibration standard container to the MANUAL fitting.

1. Prepare the calibration standard. Refer to [Prepare the calibration standard](#) on page 64.
2. Connect 1/4-in. OD x 1/8-in. ID PFA tubing to the MANUAL fitting. Make sure that the tubing length is 2 to 2.5 (6.5 to 8.2 ft).
3. Put the tubing that is plumbed to the MANUAL fitting in the calibration standard container. Put the container at the same height as the sample pump in the analyzer.

7.4 Prepare the calibration standard

⚠ CAUTION	
	Chemical exposure hazard. Obey laboratory safety procedures and wear all of the personal protective equipment appropriate to the chemicals that are handled. Refer to the current safety data sheets (MSDS/SDS) for safety protocols.
⚠ CAUTION	
	Chemical exposure hazard. Dispose of chemicals and wastes in accordance with local, regional and national regulations.

Items to collect:

- Deionized water, 5 L
- Volumetric flask, 1 L (5x)
- Personal protective equipment (refer to MSDS/SDS)

Before starting:

- Put all hygroscopic chemicals in crystal form in a 105 °C oven for 3 hours to remove all water.
- Mix the prepared solutions with a magnetic stirrer or invert the solutions until all of the crystals are fully dissolved.

- If the purity of the chemical to be used is different than the purity given for the chemical in the steps that follow, adjust the quantity of chemical used. Refer to [Table 17](#) for an example.

Shelf life and storage of calibration standards:

- TOC standards prepared from potassium hydrogen phthalate (KHP) are normally stable for 1 month when kept in a closed glass container at 4 °C.
- All the other standards (e.g., TOC prepared from acetic acid, TIC and TN standards) should be used within 48 hours.

Prepare the calibration standard for TIC/TOC/TN span calibrations and span checks as follows. Do not use an off-the-shelf TOC standard solution.

Note: The concentration of the calibration standards and the operation range for span calibrations and span checks are set on the SPAN CALIBRATION screen. Refer to [Start a span calibration or span check](#) on page 63.

Procedure:

1. Put on the personal protective equipment identified in the safety data sheet (MSDS/SDS).
2. Prepare a 1000-mgC/L TOC standard solution as follows:
 - a. Add one of the chemicals that follow to a clean 1-L volumetric flask.

Note: To prepare a higher concentration of TOC standard than 1000-mgC/L, refer to [Table 18](#).

 - KHP (potassium hydrogen phthalate, $C_8H_5KO_4$)— 2.13 g (99.9% purity); water solubility: 80 g/L at 20 °C
 - Acetic acid ($C_2H_4O_2$)—2.51 g (99.8% purity); water solubility: can be mixed in all proportions
 - Glucose ($C_6H_{12}O_6$)—2.53 g (99% purity); water solubility: 512 g/L at 25 °C
 - b. Fill the flask 80% to the 1-L mark with deionized water. When the crystals are fully dissolved, fill the flask to the 1-L mark with deionized water.
3. Prepare a 1000-mgC/L TIC standard solution as follows:
 - a. Add one of the chemicals that follow to a clean 1-L volumetric flask.
 - Sodium carbonate (Na_2CO_3)—8.84 g (99.9% purity)
 - Sodium hydrogen carbonate ($NaHCO_3$)—7.04 g (99.5% purity)
 - Potassium carbonate (K_2CO_3)—11.62 g (99.0% purity)
 - b. Fill the flask to the 1-L mark with deionized water.
4. Prepare a 1000-mgN/L TN standard solution as follows:
 - a. Add one of the chemicals that follow to a clean 1-L volumetric flask.
 - Nitric acid (HNO_3)—6.43 g (70% purity)
 - Cesium nitrate, ($CsNO_3$)—14.05 g (99% purity)
 - Sodium nitrate, ($NaNO_3$)—6.07 g (99% purity)
 - b. Fill the flask to the 1-L mark with deionized water.
5. Prepare a TIC/TOC/TN calibration standard.

For example, to prepare a 50-mgC/L TOC and 10-mgN/L TN, put 50 g of the 1000-mgC/L TOC standard and 10 g of the 1000-mgN/L standard in a clean 1-L volumetric flask. Fill the flask to the 1-L mark with deionized water.
6. To prepare a TOC only standard with a concentration less than 1000-mgC/L, dilute the prepare standards with deionized water.

For example, to prepare a 50 mg/L standard solution, put 50 g of the 1000-mg/L prepared standard in a clean 1-L volumetric flask. Fill the flask to the 1-L mark with deionized water.

Calibration

7. To prepare a standard with a concentration less than 5-mg/L, prepare the standard with two or more dilution steps.

For example, to prepare a 1-mgC/L (ppm) standard, first prepare a 100-mgC/L standard. Then use the 100-mgC/L standard to prepare the 1-mgC/L standard. Put 10 g of the 100-mgC/L standard in a clean 1-L volumetric flask. Fill the flask to the 1-L mark with deionized water.

8. To prepare a standard with a concentration at $\mu\text{g/l}$ (ppb) levels, use multiple dilution steps.

Table 17 Quantity of KHP at different purities to prepare a 1000-mgC/L standard

Purity of KHP	Quantity of KHP
100%	2.127 g
99.9%	2.129 g
99.5%	2.138 g
99.0%	2.149 g

Table 18 Quantity of KHP to prepare different concentrations of TOC standard

Concentration of TOC standard	Quantity of 99.9% KHP
1000 mgC/L	2.129 g
1250 mgC/L	2.661 g
1500 mgC/L	3.194 g
2000 mgC/L	4.258 g
5000 mgC/L	10.645 g
10000 mgC/L	21.290 g

Section 8 User interface and navigation

8.1 Keypad description

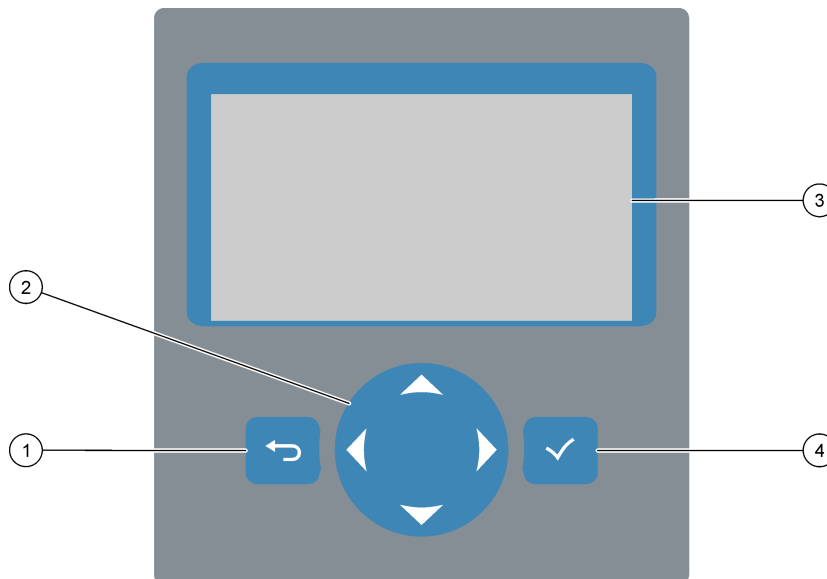

1 Back key —Push to go back to the previous screen or cancel changes. Push for 1 second to go to the main menu.	3 Display
2 Arrow keys — Push to select menu options or to enter numbers and letters.	4 Enter key —Push to confirm and go to the next screen.

8.2 Reaction Data screen

The Reaction Data screen is the default (home) screen. The Reaction Data screen shows the current reaction information and the results of the last 25 reactions. Refer to [Figure 21](#).

Note: If no key is pushed for 15 minutes, the display goes back to the Reaction Data screen.

Push ✓ to see the Reagent Status screen and then the main menu.

Note: To see more than the last 25 reactions, push the enter key to go to the main menu, then select OPERATION > REACTION ARCHIVE. Enter the reaction date for the first reaction to show on the display.

Figure 21 Reaction Data screen

1	SYSTEM RUNNING	09:17:28	12-09-02
2	09:13:02	12-09-02	REACTION START
3	TIC & TOC	STREAM 1	REACTION TYPE
4		TOC	REACTION PHASE
5		1	RANGE
6		266 s	REACTION TIME
7		360 s	REACTION DURATION
8	REACTION RESULT	TIC mgC / l	TOC mgC / l
	09:07:02 12-09-02	S1 ✓ 130.0	540.0
	09:01:02 12-09-02	S2 ✓ 3.6	3.6
	08:55:02 12-09-02	S3 ✓ 7.2	7.2
	08:49:02 12-09-02	S4 x 10.7	10.7
	08:43:02 12-09-02	S5 x 14.3	14.3
	08:37:02 12-09-02	CF 0.9	7.9

1	Status message (refer to Status messages on page 68)	5	Operation range (1, 2 or 3)
2	Reaction start time and date	6	Reaction time since start (seconds)
3	Reaction type	7	Total reaction time (seconds)
4	Reaction phase	8	Results of the last 25 reactions: start time, date, record type ¹⁴ and results. Refer to Table 19 for the record types.

Table 19 Record types

Symbol	Description	Symbol	Description
S1 ... S6	Sample Stream 1 to 6	ZC	Zero calibration
M1 ... M6	Manual Stream 1 to 6	ZK	Zero check
✓	There is sample or the quantity of air bubbles in the sample stream and manual stream is small.	ZM	Zero adjust value set manually
x	There is no sample or the quantity of air bubbles in the sample stream and manual stream is large.	SC	Span calibration
CF	Full cleaning reaction	SK	Span check
RW	Reactor wash reaction	SM	Span adjust value set manually
RS	Remote standby reaction	A1 ... A6	24-hour average result, Sample Stream 1 to 6

8.3 Status messages

A status message shows in the top-left corner of the Reaction Data screen and the Reagent Status screen. The sequence of the status messages in [Table 20](#) show the priority from highest to lowest.

¹⁴ TIC, TOC, TC and VOC. In addition, the calculated results (COD and BOD) show on the display when the DISPLAY setting on the COD PROGRAM and/or BOD PROGRAM menu is set to YES (default: OFF).

Table 20 Status messages

Message	Description
SYSTEM MAINTENANCE	The instrument is in maintenance mode. The maintenance switch (Input 22) is set to on.
SYSTEM FAULT	<p>The instrument needs immediate attention. Measurements have stopped. The 4–20 mA outputs are set to the FAULT LEVEL setting (default: 1 mA). The fault relay (Relay 20) is on.</p> <p>To identify the system fault, push ✓ to go to the main menu, then select OPERATION > FAULT ARCHIVE. Faults and warnings preceded by an "*" are active.</p> <p>To start the analyzer again, complete the troubleshooting steps in the Maintenance and Troubleshooting Manual.</p> <p>Note: "FAULT LOGGED" shows intermittently on the top-right corner of the screen where the date and time show.</p>
SYSTEM WARNING	<p>The instrument needs attention to prevent a failure in the future. Measurements continue. The fault relay (Relay 20) is on.</p> <p>To identify the warning, push ✓ to go to the main menu, then select OPERATION > FAULT ARCHIVE. Faults and warnings preceded by an "*" are active.</p> <p>Complete the troubleshooting steps in the Maintenance and Troubleshooting Manual.</p> <p>Note: "FAULT LOGGED" shows intermittently on the top-right corner of the screen where the date and time show.</p>
SYSTEM NOTE	<p>There is a notification. The notification shows on the display (e.g., 86_POWER UP).</p> <p>Note: "FAULT LOGGED" shows intermittently on the top-right corner of the screen where the date and time show.</p>
SYSTEM CALIBRATION	The instrument is in calibration mode (span calibration, span check, zero calibration or zero check).
SYSTEM RUNNING	Normal operation
SYSTEM STOPPED	The instrument was stopped with the keypad or a fault occurred.
REMOTE STANDBY	<p>The instrument was put in remote standby with the optional digital input for remote standby. The analog outputs and relays do not change. Refer to REMOTE STANDBY in Start or stop measurements on page 71.</p> <p>Note: A grab sample measurement can be done when the instrument is in remote standby.</p>

8.4 Reaction Graph screen

Push ↵ to go to the Reaction Graph screen. The Reaction Graph screen shows the reaction in progress. Refer to [Figure 22](#).

Note: To go to back to the Reaction Data screen, push the enter key.

Figure 22 Reaction Graph screen

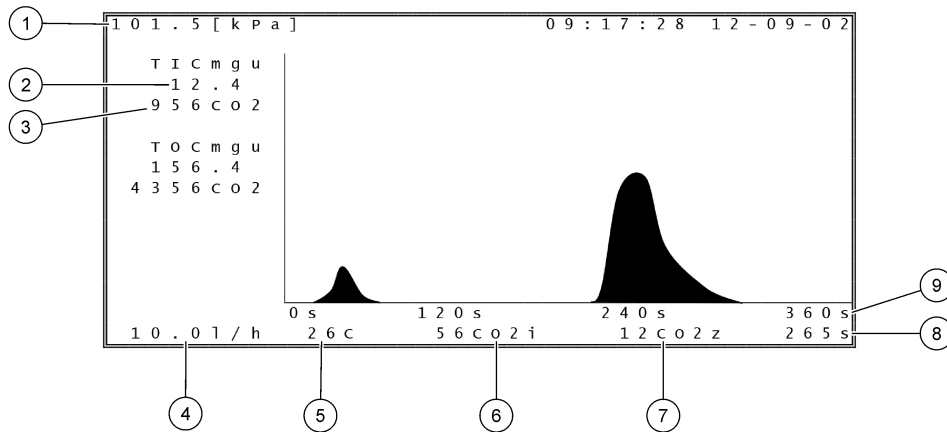

1 Atmospheric pressure	6 CO ₂ instantaneous (i) measured value
2 TIC mgC/L un-calibrated (mgu), no compensation for atmospheric pressure	7 CO ₂ zero (z) value at start of reaction
3 CO ₂ peak value	8 Reaction time since start (seconds)
4 Oxygen flow (L/hour)	9 Total reaction time
5 Temperature of the analyzer (°C)	

Section 9 Operation

9.1 Start or stop measurements

1. Push ✓ to go to the main menu, then select OPERATION > START,STOP.
2. Select an option.

Option	Description
REMOTE STANDBY	<p>An optional digital input is used to put the analyzer in remote standby (e.g., from a flow switch). When the analyzer is in remote standby:</p> <ul style="list-style-type: none">• "REMOTE STANDBY" shows in the top-left corner of the Reaction Data screen and the Reagent Status screen.• Measurements stop and the analog outputs and relays do not change.• The analyzer does one remote standby (RS) reaction at 24-hour intervals at the time set in the PRESSURE/FLOW TEST menu (default: 08:15 AM) in the SYSTEM CONFIGURATION > SEQUENCE PROGRAM menu.• Sample is not used during the remote standby reaction, only acid reagent and base reagent is used.• A grab sample measurement can be done. <p>When REMOTE STANDBY is unselected, the analyzer starts measurements unless the analyzer was stopped with the keypad or a fault occurred.</p>
START	<p>Starts the analyzer. The analyzer does an ozone purge, pressure test, flow test, reactor purge and analyzer purge, then starts the analysis of the first stream in the programmed stream sequence. If a fault has occurred, the analyzer cannot be started until the fault is removed.</p> <p>Note: To start the analyzer without the pressure test or flow test (quick startup), select START and push the RIGHT arrow key at the same time. When a quick startup is done, a 28_NO PRESSURE TEST warning occurs. The warning stays active until a pressure test is passed.</p> <ul style="list-style-type: none">• Ozone purge—Pushes residual ozone through the ozone destructor.• Pressure test—Identifies if there is a gas leak in the analyzer.• Flow test—Identifies if there is a blockage in the gas exhaust or the sample out lines.• Reactor purge—Removes liquid from the reactor through the SAMPLE OUT fitting.• Analyzer purge—Removes CO₂ gas from the CO₂ analyzer through the EXHAUST fitting. <p>Note: If the analyzer is started while the remote standby signal is active, the analyzer goes to remote standby.</p>
FINISH & STOP	<p>Stop the analyzer after the last reaction is completed. The analyzer does an ozone purge, reactor purge and analyzer purge and then stops.</p>
EMERGENCY STOP	<p>Stops the analyzer before the last reaction is completed. The analyzer does an ozone purge, reactor purge and analyzer purge and then stops.</p> <p>Note: If EMERGENCY STOP is selected soon after FINISH & STOP is selected, an EMERGENCY STOP is done.</p>

9.2 Measure a grab sample

The grab sample settings can be changed while the analyzer is in operation, unless:

- A manual mode (grab sample) sequence is scheduled to start when the last reaction is completed.
- A manual mode sequence has started.

Plumb and configure the analyzer to do a grab sample measurement as follows:

1. Use 1/4-in. OD x 1/8-in. ID PFA tubing to plumb the grab sample container(s) to a MANUAL fitting(s).
Refer to [Specifications](#) on page 3 for the sample specifications.
2. Put the tubing in the grab sample. Put the grab sample at the same height as the sample pump in the analyzer.
3. Do a sample pump test for the manual stream(s) to identify the correct forward and reverse times. Refer to [Do a sample pump test](#) on page 49.
4. Set the sample pump times for the manual stream(s). Refer to [Set the sample pump times](#) on page 49.
5. Select OPERATION > MANUAL PROGRAM.
6. Select an option.

Option	Description
RUN AFTER NEXT REACTION	Starts the manual mode (grab sample) sequence after the next reaction. If the analyzer is stopped, the manual mode sequence will start immediately. Note: If the analyzer has the Manual-AT Line option, push the green button to select RUN AFTER NEXT REACTION. The Manual-AT Line option is a small box with only a green button. The Manual-AT Line cable is connected to the analyzer. Note: When a manual mode sequence starts, all of the cleaning cycle, pressure/flow tests, zero or span cycles stop temporarily. In addition, the reverse operation of the sample pump is disabled (default).
RUN AFTER	Starts the manual mode (grab sample) sequence at a selected time (default: 00.00).
RETURN TO ON-LINE SAMPLING	Sets the analyzer to stop or go back to online operation when the manual mode sequence is completed. YES —The analyzer goes back to online operation. NO (default)—The analyzer stops.
RESET MANUAL PROGRAM	Sets the MANUAL PROGRAM settings back to the factory default settings.
MANUAL x, x RANGE x	Sets the number of reactions and the operation range for each manual (grab sample) stream. MANUAL —The first setting is the manual valve number (e.g., MANUAL VALVE 1 is connected to the MANUAL 1 fitting on the side of the analyzer). The second setting is the number of reactions done at the manual stream before the analyzer does reactions at the next manual stream. RANGE —Sets the operation range for each manual stream. Options: 1, 2 or 3 (default). Refer to the SYSTEM RANGE DATA screen to see the operation ranges. Select OPERATION > SYSTEM RANGE DATA. If the concentration of the grab sample is not known, select AUTO. Note: If RANGE is set to AUTO, enter 5 for the number of reactions so the analyzer can find the best operation range. It may be necessary to discard the first two or three analysis results. Note: When a MANUAL is set to “-”, “-” and RANGE is set to “-”, the manual stream is not measured.

9.3 Save data to an MMC/SD card

Save the reaction archive, fault archive, configuration settings and/or diagnostic data to an MMC/SD card.

1. Put the supplied MMC/SD card in the MMC/SD card slot. The MMC/SD card slot is an opening on the edge of the top door.
2. Select MAINTENANCE > DIAGNOSTICS > DATA OUTPUT.

3. Select an option.

Option	Description
OUTPUT DEVICE	<p>Sets where the analyzer sends the data. Options: PRINTER, PC or MMC/SD CARD (default).</p> <p>Note: <i>PRINTER and PC are not used.</i></p> <p>To configure the settings for the MMC/SD card, select MAINTENANCE > COMMISSIONING > DATA PROGRAM. Refer to Configure the communication settings on page 58.</p> <p>Make sure that the MMC/SD card is configured with FAT, FAT12/16 or FAT32 file systems. As an alternative, use an SDHC card. Data is saved to an MMC/SD card in text format. The binary files on the card are system firmware (sysfrmw.hex) and system configuration (syscnfg.bin).</p>
SEND REACTION ARCHIVE	<p>Sends the contents of the reaction archive to the output device. Set the start date and number of entries to send, then select START SENDING. OUTPUT ITEMS shows the number of entries sent. The analyzer sends the data in the display language.</p> <p>If PAUSE SENDING is selected, entries are not sent for 60 seconds or until PAUSE SENDING is selected again.</p> <p>If the output device is an MMC/SD card, the reaction archive is saved to the file RARCH.txt.</p> <p>Note: <i>To see the reaction archive, go to the main menu, then select OPERATION > REACTION ARCHIVE.</i></p> <p>Refer to Table 21 and Table 22 for descriptions of the data sent. To select standard or engineering data, select DATA PROGRAM > PRINT MODE.</p>
SEND FAULT ARCHIVE	<p>Sends the contents of the fault archive to the output device. Select START SENDING. OUTPUT ITEMS shows the number of entries sent. The data is sent in the display language.</p> <p>If PAUSE SENDING is selected, entries are not sent for 60 seconds or until PAUSE SENDING is selected again.</p> <p>If the output device is an MMC/SD card, the fault archive is saved to the file FARCH.txt.</p> <p>Note: <i>To see the fault archive, go to the main menu, then select OPERATION > FAULT ARCHIVE. The fault archive contains the last 99 faults and warnings.</i></p>
SEND CONFIGURATION	<p>Sends the analyzer settings to the output device. Select START SENDING. OUTPUT ITEMS shows the number of entries sent. The data is sent in the display language.</p> <p>If PAUSE SENDING is selected, entries are not sent for 60 seconds or until PAUSE SENDING is selected again.</p> <p>If the output device is an MMC/SD card, the analyzer settings are saved to the file CNFG.txt.</p>
SEND ALL DATA	<p>Sends the reaction archive, fault archive, analyzer settings and diagnostics data to the output device. Select START SENDING. The data is sent in English.</p> <p>If PAUSE SENDING is selected, entries are not sent for 60 seconds or until PAUSE SENDING is selected again.</p> <p>If the output device is an MMC/SD card, the analyzer settings are saved to the file ALLDAT.txt.</p>
DATA PROGRAM	<p>Goes to the MAINTENANCE > COMMISSIONING > DATA PROGRAM menu to set the communication settings for the output devices: MMC/SD card and Modbus.</p>

Table 21 Reaction archive data—Standard mode

Item	Description
TIME	Time the reaction started
DATE	Date the reaction started
S1:2	Reaction type (e.g., Stream 1) and operation range (e.g., 2)
TCmgC/L	Calibrated TC value in mgC/L (TC is TIC + NPOC + POC)
TICmgC/L	Calibrated TIC value in mgC/L
TOCmgC/L	TIC + TOC analysis —Calibrated TOC value in mgC/L (TOC is NPOC) VOC analysis —Calculated TOC value in mgC/L (TOC is calculated as TC – TIC)
TNmgN/L	Calibrated TN value in mgN/L
COD/BODmgO/L	Calculated COD and/or BOD value in mgO/L (if set to on in the COD PROGRAM and/or BOD PROGRAM menu)
VOCmgC/L	Calculated VOC value in mgC/L (VOC is calculated as TC – TIC – NPOC)

Table 22 Reaction archive data—Engineering mode (TIC + TOC analysis)

Item	Description
TIME	Time the reaction started
DATE	Date the reaction started
S1:2	Reaction type (e.g., Stream 1) and operation range (e.g., 2)
CO2z	Zero adjust value for the CO ₂ analyzer for the last reaction
CO2p	Maximum height of the CO ₂ peak
mgu	Un-calibrated value in mgC/L
mgc	Calibrated value in mgC/L
COD/BODmgO/L	Calculated COD and/or BOD value in mgO/L (if set to on in the COD PROGRAM and/or BOD PROGRAM menu)
DegC	Analyzer temperature (°C)
Atm	Atmospheric pressure (kPa)
SAMPLE	Sample quality (%) from the Sample Sensor signal used to activate the SAMPLE STATUS output
SMPL PUMP	The five items, which are number coded or number data, give information on the sample pump as follows: 1) Operation mode (0 = time mode or 1 = pulse mode) 2) Number of pulses during operation (e.g., injection) 3) Total time (milliseconds) for the total number of pulses 4) The time (milliseconds) for the last pulse 5) Error counter (0 to 6). When a pulse is not done or identified, the pump goes to time mode for that specific operation (e.g., injection or synchronization). A pump warning only occurs if there are six consecutive failures.
ACID PUMP	Error counter for the acid pump. Refer to SMPL PUMP description.
BASE PUMP	Error counter for the base pump. Refer to SMPL PUMP description.
COOLER	The status of the cooler (e.g., OFF).
O3 HEATER	The status of the ozone destructor heater (e.g., OFF).
N PUMP	Error counter for the nitrogen pump. Refer to SMPL PUMP description.
TNSS0	The intensity reading on the TN sample at the nitrogen signal wavelength (default: 217 nm) when the light source is off.

Table 22 Reaction archive data—Engineering mode (TIC + TOC analysis) (continued)

Item	Description
TNSS1	The intensity reading on the TN sample at the nitrogen signal wavelength (default: 217 nm) when the light source is on.
TNSRO	The intensity reading on the TN sample at the nitrogen reference wavelength (default: 265 nm) when the light source is off.
TNSR1	The intensity reading on the TN sample at the nitrogen reference wavelength (default: 265 nm) when the light source is on.
NWS0	The intensity reading on the DI water at the nitrogen signal wavelength (default: 217 nm) when the light source is off.
NWS1	The intensity reading on the DI water at the nitrogen signal wavelength (default: 217 nm) when the light source is on.
NWR0	The intensity reading on the DI water at the nitrogen reference wavelength (default: 265 nm) when the light source is off.
NWR1	The intensity reading on the DI water at the nitrogen reference wavelength (default: 265 nm) when the light source is on.

HACH COMPANY World Headquarters

P.O. Box 389, Loveland, CO 80539-0389 U.S.A.
Tel. (970) 669-3050
(800) 227-4224 (U.S.A. only)
Fax (970) 669-2932
orders@hach.com
www.hach.com

HACH LANGE GMBH

Willstätterstraße 11
D-40549 Düsseldorf, Germany
Tel. +49 (0) 2 11 52 88-320
Fax +49 (0) 2 11 52 88-210
info-de@hach.com
www.de.hach.com

HACH LANGE Sàrl

6, route de Compois
1222 Vérenaz
SWITZERLAND
Tel. +41 22 594 6400
Fax +41 22 594 6499

