

# **WORLD CLIMATE RESEARCH PROGRAMME**

## **BASELINE SURFACE RADIATION NETWORK (BSRN)**

Operations Manual  
Version 2.1

L.J.B. McArthur

APRIL 2005

WCRP-121  
WMO/TD-No. 1274



## **Acknowledgements**

The efforts required in creating any document far exceed the capabilities of any one person. This manual has been no exception. I would particularly like to thank the World Meteorological Organization for financial support during the initial drafting of this report and the Atmospheric Environment Service for providing me with the necessary time away from my regular duties to research the manual. I would also like to recognize the support of the International Council for Science and the International Oceanographic Commission of the UNESCO, the other sponsors of the World Climate Research Programme of which the Baseline Surface Radiation Network is part. The first draft was ably reviewed at the Boulder 1996 meeting of the BSRN. While all the participants at the meeting provided input I would especially like to thank the following individuals who acted as group leaders during that process: Klaus Dehne, Bruce Forgan, Roger Newson, Rolf Philipona and Tom Stoffel. Finally, I would like to thank Ellsworth Dutton as manager of the BSRN for his continuous encouragement throughout the production of this work.

A number of individuals have graciously allowed manuscripts to be placed in the annexes for easy access. I would encourage readers, if they use these papers, to reference them directly to the original report or journal.

## Preface to the First Edition

Like all aspects of the Baseline Surface Radiation Network, this manual is in its infancy. The ideas contained within may be new to many, but have been applied successfully at various locations throughout the globe. On the one hand this indicates that these concepts should be considered seriously before being rejected, but on the other hand there may be some that are unworkable because of various climatic or operational factors. I would encourage all those using this manual not to reject any procedures without first carefully attempting to put them into operation. There is an anecdote within the meteorological community that must be overcome if the operation of the BSRN is to be successful. The question is asked, "How long does it take for a new instrument to be accepted as operational?" The answer, "One generation of meteorologists." Let this not be the case within the BSRN!

Some instructions or ideas within the manual may be unclear. If this is the case, I would appreciate having these reported to me as quickly as possible. I believe that everyone who has ever written step-by-step instructions has fallen into the trap of missing a step, or assuming too much. I would encourage scientists and technicians alike who use this manual to also apply "common sense" to the problem to overcome any omissions that I may have made.

Although the WMO allowed me a significant amount of travel and opportunity to observe how various stations were operated, I am sure that excellent ideas have been missed within this first version of the manual, even with the significant help of those who reviewed it at the BSRN meeting in August 1996. Although only one person can place ideas on paper (or its virtual counterparts), the contents of this manual must remain a group effort if we are to build a radiation observing system of which we can be proud in our years of retirement. To this end I encourage new ideas be brought forward and new areas suggested for inclusion in the next revision.

As paper gives way to electronic publications, the idea of editorial revisions has changed substantially over the last few years. Where once the second edition of a book might be expected a decade after the first printing, our expectations have increased to seeing something new on the WEB every day. It is hoped that minor revisions of the manual (clarifications etc.) can be put into place almost immediately and the revision number of the electronic version of the manual altered to reflect any changes. Major revisions (e.g. new sections) will obviously be less frequent, but will come out not only electronically, but also as a new printed manual.

Finally, and again, this manual will improve with the feedback of the users. I urge anyone to contact me with any and all suggestions that might improve this manual..

Bruce McArthur  
Experimental Studies Division  
Atmospheric Environment Service  
4905 Dufferin Street  
Downsview, Ontario, CANADA  
M3H 5T4

Telephone: 1 416 739 4464  
Facsimile: 1 416 739 4281  
Email: bruce.mcarthur@ec.gc.ca

## Preface to the Second Edition

The World Climate Research Programme (WCRP) Baseline Surface Radiation Network (BSRN) has been operating as a network of surface radiation monitoring observatories for over 10 years. During this time period significant progress has been made in the measurement of various radiation quantities. Others have not progressed as rapidly. Observations of other quantities are now being requested by the user community. The process of improving measurements and the requirement for more information about the atmosphere and the radiation budget at the surface will continue indefinitely. The second edition of this manual recognizes the improvements that have been made during the time since the writing of the first edition. This is most evident in the inclusion of a chapter on the measurement of aerosol optical depth. Many advances that one would anticipate in a manual of this type have yet to be included, however, because questions remain about the veracity of these, they have not been left for a later addition until they prove themselves. In a number of cases, the thermal offset problem being the most notable, suggestions have been included in the hope that more research will proceed in these areas, especially in the various climatic regions of the network.

Overall, the manual has been updated in a variety of places, rearranged where it was believed the flow could be improved and the Annexes that were considered dated removed. In turn, several new Annexes were included to provide the users of the manual more information on instruments and methods of observation. It is hoped that readers of this second version will find the overall presentation improved and therefore more useful.

Bruce McArthur  
Experimental Studies Division  
Meteorological Service of Canada  
4905 Dufferin Street  
Downsview, Ontario, CANADA  
M3H 5T4

Telephone: 1 416 739 4464  
Facsimile: 1 416 739 4281  
Email: [bruce.mcarthur@ec.gc.ca](mailto:bruce.mcarthur@ec.gc.ca)

## Table of Contents

Acknowledgements	I
Preface to the First Edition	II
Preface to the Second Edition	III
1.0 Introduction	1
1.1 Overall goals and purpose of the BSRN	2
1.2 Purpose and scope of the operations manual	3
1.3 Specific objectives and research activities	5
2.0 Sampling Frequency and Accuracy Requirements for BSRN Stations	8
2.1 Sampling Frequency	8
2.1.1 Sampling Frequency of Radiation Measurements	8
2.1.2 Sampling Frequency of Ancillary Measurements	9
2.2 Uncertainty of Measurements	9
2.2.1 Uncertainty in Radiation Measurements	9
2.2.1.1 Direct Solar Irradiance	9
2.2.1.2 Diffuse Radiation	11
2.2.1.3 Global Radiation	12
2.2.1.4 Reflected Solar Radiation	12
2.2.1.5 Downwelling Infrared Radiation	12
2.2.1.6 Upwelling Infrared Radiation	13
2.2.2 Accuracy of Meteorological Measurements	13
2.3 Accuracy of Data Acquisition Equipment	13
2.3.1 Time	13
2.3.2 Data Acquisition System Accuracy	15
3.0 The BSRN Site	16
3.1 Geographic Location of Site	16
3.1.1 General Considerations	16
3.1.2 Horizon	17
3.1.3 Latitude, Longitude, Elevation	17
3.1.4 General site description for the Archive	18
3.2 BSRN Station Information Document	18
3.2.1 General Description	19
3.2.2 Site Description	19
3.2.3 Station Description	19
3.3 Instrument Exposure	21
3.4 Additional Station Requirements	21
3.4.1 Ease of Access	21
3.4.2 Electrical Power	21
3.4.3 Communication	22
3.4.4 Security	24
3.5 Site Preparation	24
3.5.1 Instrument siting	24
3.5.2 Instrument platforms	26
3.5.3 Cables	27
3.5.3.1 Signal cables	27
3.5.3.2 Electrical Cable	28
4.0 Installation of Radiation Instruments	30
4.1 General	30
4.2 Installation of pyranometers and pyrgeometers	30
4.2.1 Pre-installation Checks and Service	30
4.2.2 Mechanical Installation	31
4.2.2.1 Ventilated housing	32

4.2.3	Mechanical installation of shaded sensors (pyranometers and pyrgeometers)	<u>33</u>
4.3	Installation of instruments for the measurement of direct beam radiation	<u>39</u>
4.3.1	General Considerations	<u>39</u>
4.3.2	Pre-installation checks and service	<u>39</u>
4.3.3	Mechanical Installation	<u>40</u>
4.4	Installation of Solar Tracking and Pointing Devices	<u>40</u>
5.0	Data Acquisition	<u>44</u>
5.1	Introduction	<u>44</u>
5.2	Set-up Considerations	<u>45</u>
5.3	Standard Practices	<u>45</u>
5.4	Suggested Practices	<u>45</u>
6.0	Maintenance	<u>47</u>
6.1	Introduction	<u>47</u>
6.2	Daily Maintenance	<u>47</u>
6.3	Weekly Maintenance	<u>51</u>
6.4	Long-term maintenance	<u>51</u>
6.4.1	Semi-annual maintenance	<u>51</u>
6.4.2	Annual maintenance	<u>52</u>
7.0	Measurement of Aerosol Optical Depth	<u>53</u>
7.1	Introduction	<u>53</u>
7.2	Instrument and Wavelength Specifications	<u>54</u>
7.2.1	Instrument Specifications	<u>54</u>
7.2.2	Wavelength Specifications	<u>54</u>
7.3	Data Acquisition	<u>56</u>
7.3.1	Sampling	<u>56</u>
7.3.2	Data Acquisition	<u>56</u>
7.4	Calibration	<u>56</u>
7.4.1	General	<u>56</u>
7.4.2	On-site 'Langley' Style Procedures	<u>57</u>
7.4.2.1	Quality Assurance Procedures for Langley Calibration	<u>58</u>
7.4.2.2	Ratio-Langley Technique	<u>58</u>
7.4.2.3	Objective Algorithm	<u>60</u>
7.4.3	Lamp Calibrations	<u>60</u>
7.5	Maintenance	<u>61</u>
7.6	Archive Information	<u>62</u>
8.0	Radiometer Calibration	<u>64</u>
8.1	Introduction	<u>64</u>
8.2	Pyrheliometer Calibration	<u>64</u>
8.2.1	Absolute Cavity Radiometer/Pyrheliometer Calibration	<u>64</u>
8.2.2	Detailed procedures	<u>65</u>
8.3	Pyranometer Calibration	<u>66</u>
8.4	Pyrgeometer Calibration	<u>67</u>
9.0	Radiation Data Reduction and Quality Assurance Procedures	<u>70</u>
9.1	Introduction	<u>70</u>
9.2	Standard Data Reduction Procedures	<u>70</u>
9.2.1	Cavity Radiometer and Pyrhemometer	<u>70</u>
9.2.2	Pyranometers	<u>70</u>
9.2.3	Pyrgeometers	<u>71</u>
9.3	Quality Assurance Techniques	<u>72</u>
9.3.1	General testing procedures	<u>72</u>
9.3.1.1	Redundancy	<u>72</u>
9.3.1.2	Visual inspection	<u>72</u>
9.3.1.3	Limit Checking	<u>72</u>
9.3.1.4	Conversion to solar time	<u>73</u>
9.3.1.5	Scanning Minimum, Maximum, Standard Deviations	<u>73</u>

9.3.2	Procedures for specific fluxes	<a href="#">73</a>
9.3.2.1	Direct, diffuse and global	<a href="#">73</a>
9.4	Data Submission to the BSRN Archive	<a href="#">74</a>
Annex A	Site Description Documentation	<a href="#">75</a>
A.1	Example of Site Description Documentation	<a href="#">81</a>
Annex B	Selected Instrumentation	<a href="#">88</a>
B 1.	Instrument Specifications	<a href="#">88</a>
B 1.1	Introduction	<a href="#">88</a>
B 2.	Pyranometers	<a href="#">91</a>
B 2.1	Eppley Laboratory Model PSP Pyranometer	<a href="#">91</a>
B 2.2	Kipp & Zonen Delft BV CM11 Pyranometers	<a href="#">91</a>
B 2.3	Kipp & Zonen Delft BV CM21/31 Pyranometers	<a href="#">93</a>
B 2.4	Kipp and Zonen Delft BV PYRANOMETER CM 31	<a href="#">94</a>
B 2.5	Carter-Scott Middleton EP09 Pyranometer	<a href="#">95</a>
B 2.6	Eko MS-802 Pyranometer	<a href="#">96</a>
B 2.7	Eppley Black and White Pyranometer (Model 8-48)	<a href="#">97</a>
B 2.8	Schenk Star Pyranometer	<a href="#">97</a>
B 3.	Cavity Radiometers and Pyrhemometers	<a href="#">99</a>
B 3.1	Eppley Laboratory HF/AHF Cavity Radiometer	<a href="#">99</a>
B 3.2	PMOD/PMO6	<a href="#">100</a>
B 3.3	Eppley Normal Incidence Pyrhemometer	<a href="#">101</a>
B 3.4	Kipp and Zonen Delft BV CH1	<a href="#">102</a>
B 3.5	Eko MS-53A Pyrhemometer	<a href="#">103</a>
B 3.6	Carter-Scott Middleton DN5 & DN5-E Pyrhemometer	<a href="#">103</a>
B 4.	Pyrgeometers	<a href="#">106</a>
B 4.1	Eppley Precision Infrared Radiometer (PIR)	<a href="#">106</a>
B 4.2	Eko MS-201 Precision Pyrgeometer	<a href="#">106</a>
B 4.3	Kipp and Zonen Delft CG4 Pyrgeometer	<a href="#">107</a>
B 5.	Sunphotometers and Spectral Radiometers	<a href="#">108</a>
B 5.1	Kipp and Zonen POM-01L Sky Radiometer	<a href="#">108</a>
B 5.2	WRC/PMOD Precision Filter Radiometer (PFR)	<a href="#">108</a>
B 5.3	EKO Instruments MS-110A Sunphotometer	<a href="#">109</a>
B 5.4	Yankee Environmental Systems Model SPUV Sunphotometer	<a href="#">109</a>
B 5.5	CIMEL Electronique Automatic Sun Tracking Photometer CE 318	<a href="#">110</a>
B 5.6	Carter-Scott Design Middleton SP02 Sunphotometer	<a href="#">110</a>
B 5.7	Carter-Scott Design Middleton SP01 Sunphotometer	<a href="#">111</a>
Annex C	The Geometry and Measurement of Diffuse Radiation	<a href="#">113</a>
C 1.	Final Report of the Working Group on Solar Diffuse Shading Geometry	<a href="#">114</a>
C 1.1	Terms of reference	<a href="#">114</a>
C 1.2	Activities of the Working Group	<a href="#">114</a>
C 1.3	Statements and recommendations	<a href="#">115</a>
C 1.4	References	<a href="#">115</a>
C 2.	Annex 1 to Diffuse Geometry WG Report: The effect of diffusometer shading geometry	<a href="#">116</a>
C 2.1	Introduction	<a href="#">116</a>
	Geometrical data of diffusometers	<a href="#">116</a>
C 2.2	The calculation method	<a href="#">116</a>
C 2.2.1	The penumbra functions.	<a href="#">117</a>
C 2.2.2	Sky functions	<a href="#">117</a>
C 2.2.3	Circumsolar diffuse irradiances	<a href="#">119</a>
C 2.3	The measurement method	<a href="#">120</a>
C 2.3.1	Intercalibration of pyranometers	<a href="#">121</a>
C 2.3.2	Dependence of ratios of measured diffuse radiation values on other parameters	<a href="#">121</a>
C 2.4	Reduction of measurements to standard geometry	<a href="#">122</a>
C 2.5	Results	<a href="#">122</a>
C 2.6	Acknowledgements	<a href="#">123</a>
C 2.7	References	<a href="#">123</a>

C 3.	Annex 2 to the Diffuse Geometry WG Report: Optimization of Diffusometers to Pyrheliometers .....	<a href="#">124</a>
C 3.1	Introduction .....	<a href="#">124</a>
C 3.2	Basic considerations .....	<a href="#">124</a>
C 3.2.1	Sky functions .....	<a href="#">125</a>
C 3.2.2	The pyrheliometers and pyranometers .....	<a href="#">126</a>
C 3.2.3	Existing diffusometers .....	<a href="#">126</a>
C 3.2.4	Optimal systems .....	<a href="#">127</a>
C 3.3	References .....	<a href="#">128</a>
C 4.	Annex 3 to Diffuse Geometry WG Report: Examination of shading mechanisms for diffuse sky irradiance measurement for use in the BSRN .....	<a href="#">129</a>
C 4.1	Introduction .....	<a href="#">129</a>
C 4.2	Irradiance in the instrument: Numerical solutions .....	<a href="#">130</a>
C 4.3	Sun at zenith .....	<a href="#">130</a>
C 4.4	Sun at an arbitrary zenith angle .....	<a href="#">131</a>
C 4.5	Analytical solutions .....	<a href="#">132</a>
C 4.6	Conclusion .....	<a href="#">134</a>
C 4.7	References .....	<a href="#">134</a>
Annex D	Pyrheliometers and Pointing .....	<a href="#">135</a>
D 1.	On the Pointing Error of Pyrheliometers .....	<a href="#">135</a>
D 1.1	Introduction .....	<a href="#">135</a>
D 1.2	The method of calculation .....	<a href="#">135</a>
D 1.2.1	Radiance along the solar disk .....	<a href="#">136</a>
D 1.2.2	Radiance along the circumsolar sky .....	<a href="#">136</a>
D 1.2.3	The penumbra functions .....	<a href="#">136</a>
D 1.3	Results .....	<a href="#">136</a>
D 1.4	Conclusions .....	<a href="#">136</a>
D 1.5	References .....	<a href="#">137</a>
D 2.	Effect of Clouds on the Pyrheliometric Measurements .....	<a href="#">140</a>
D 2.1	Introduction .....	<a href="#">140</a>
D 2.2	The geometry .....	<a href="#">140</a>
D 2.2.1	Cloud edge scattering .....	<a href="#">140</a>
D 2.2.2	Cloud side reflectance .....	<a href="#">141</a>
D 2.3	Measurements .....	<a href="#">141</a>
D 2.4	The applied radiance distributions .....	<a href="#">141</a>
D 2.5	The pyrheliometers .....	<a href="#">142</a>
D 2.6	The effect of clouds .....	<a href="#">142</a>
D 2.7	Conclusions .....	<a href="#">142</a>
D 2.8	Reference .....	<a href="#">142</a>
Annex E	Suppliers of Solar Tracking Instruments (Partial Listing) .....	<a href="#">150</a>
Annex F	Suppliers of Data Acquisition Systems (Partial Listing) .....	<a href="#">151</a>
F 1.	Data Acquisition Types .....	<a href="#">151</a>
F 2.	Data Acquisition Suppliers .....	<a href="#">152</a>
Annex G	Sample log sheets .....	<a href="#">154</a>
Annex H	Common Terms and Formulas used in Uncertainty Determinations .....	<a href="#">158</a>
H 1.	Common Terms .....	<a href="#">158</a>
H 2.	Common Formulas .....	<a href="#">164</a>
H 2.1	Type A Evaluation .....	<a href="#">164</a>
H 2.2	Type B Evaluation .....	<a href="#">164</a>
Annex I	Solar Position Algorithm .....	<a href="#">166</a>
Annex J	BSRN Data Management .....	<a href="#">172</a>
Index	.....	<a href="#">174</a>

## List of Figures

Figure 1.1. Map of BSRN sites. ....	<a href="#">1</a>
Figure 3.1. Diagram indicating appropriate distances from an obstruction meteorological instrumentation (from AES Guidelines for Co-operative Climatological Autostations, Version 2.0). ....	<a href="#">25</a>
Figure 3.2. Simple post mount in concrete base ....	<a href="#">26</a>
Figure 3.3. The support structure used to elevate instruments above the local horizon ....	<a href="#">27</a>
Figure 3.4 Generalized schematic of the interface between radiation sensors (RF) and a data acquisition unit showing lightning protection and cable grounding. ....	<a href="#">29</a>
Figure 4.1. Ventilator with motor located beside the instrument as used by Deutscher Wetterdienst. ....	<a href="#">32</a>
Figure 4.2. Ventilator with the motor located beneath the instrument. Note the extra ventilation holes near the top of the housing used to reduce snow accumulation (Davos, Switzerland). ....	<a href="#">33</a>
Figure 4.3. An one-axis tracker used in shading a pyranometer ....	<a href="#">34</a>
Figure 4.4. View of two Swiss oversize tracking disks. Note how the pyranometer is physically separated from the motor and the shade device. ....	<a href="#">34</a>
Figure 4.5. Australian active tracker used for both diffuse and direct beam measurements ....	<a href="#">36</a>
Figure 4.6. Canadian computer-controlled, friction-drive tracker used for measuring direct beam, diffuse and infrared radiation using a shaded pyrgeometer. The pyrheliometer mounting block is capable of holding three instruments, including an active cavity radiometer. A second mounting place is mounted on the opposite side of the tracker. ....	<a href="#">38</a>
Figure 4.7. The contribution of the solar disk to the irradiance of pyrheliometric sensors depending on the pointing error. (A) Case of mountain aerosol and 60° solar elevation. (B) Case of continental aerosol and a 20° solar elevation. (Calculations and graph courtesy of G. Major) ....	<a href="#">41</a>
Figure 4.9. Brusag two-axis active tracker ....	<a href="#">41</a>
Figure 4.8. A single-axis synchronous motor tracker ....	<a href="#">42</a>
Figure 8.1. Percentage change in infrared flux due to case thermistor errors ....	<a href="#">69</a>
Figure C 2.1. Penumbra functions of diffusometers for 45 degrees solar elevation. ....	<a href="#">117</a>
Figure C 2.2. Compared log measured and calculated circumsolar functions. Letters A, B, C, D, E, F symbolizes different aerosol models. ....	<a href="#">119</a>
Figure C 2.3. Measured sky functions and their approximations by ones calculated for model atmosphere containing rural aerosol and haze particles. ....	<a href="#">120</a>
Figure C 2.5. Dependence of the HUNI/HUNIII on direct radiation. ....	<a href="#">122</a>
Figure C 4.1. Measured sky functions and their approximations by ones calculated for model atmosphere containing rural aerosol and haze particles too (courtesy of Major, 2001). ....	<a href="#">129</a>
Figure C 4.2. Relationship between the geometry of pyrheliometers and radiance (The relationship applies for a diffusometer when the sun is at zenith). ....	<a href="#">130</a>
Figure C 4.3a. Relationship between the shadow disc and the sensor of a pyranometer. ....	<a href="#">131</a>
Figure C 4.3b. Detail of the sensor projection on to the normal plane parallel to the shadow disc. ....	<a href="#">131</a>

Figure D 1.1. The sky functions used in this calculation. ....	<a href="#">138</a>
Figure D 1.2. The contribution of the solar disk to the irradiance of pyrheliometric sensors depending on the pointing error. Case of mountain aerosol and 60 degrees solar elevation. ....	<a href="#">138</a>
Figure D 1.3. Same as Fig. D 1.2 except the case is for continental background aerosol and 20 degrees solar elevation. ....	<a href="#">139</a>
Figure D 1.4. The contribution of the circumsolar sky to the irradiance of pyrheliometric sensors. The upper 3 curves belong to the case of continental background aerosol and 20 degrees solar elevation, the lower 3 curves belong to the case of mountain aerosol and 60 degrees solar elevation. In both group of curves the instruments are from the top to down: NIP, KIPP and ABS. ....	<a href="#">139</a>
Figure D 2.2. The geometry of cloud edge scattering. ....	<a href="#">142</a>
Figure D 2.1. Surface Irradiance: the shadow of the model cloud. ....	<a href="#">143</a>
Figure D 2.3. The geometry of cloud side reflectance. ....	<a href="#">144</a>
Figure D 2.4. Measured radiance functions: example for the cloud side reflectance (upper curve) as well the clearest cases for high and low solar elevation. ....	<a href="#">145</a>
Figure D 2.5. Measured radiance functions: various unidentified examples for cloud edge scattering and the clearest case (cloudless high sun (x)) ....	<a href="#">145</a>
Figure D 2.7. Model radiances for the cloud edge scattering and for the clear sky, mountain aerosol, h=60 degrees. ....	<a href="#">146</a>
Figure D 2.6. Model radiances of clear sky at 60° solar elevation with mountain aerosol, clear sky at 20° solar elevation with continental background aerosol and the same conditions with cloud at 1, 2 and 3° from the solar centre. ....	<a href="#">146</a>
Figure D 2.9. The basic geometrical characteristics of the pyrheliometers involved into the calculation. ....	<a href="#">147</a>
Figure D 2.8. Model radiances for the cloud edge scattering and for the clear sky, background aerosol, h=20 degrees. ....	<a href="#">147</a>
Figure D 2.10. Cloud effect for the ABS pyrheliometer group. ....	<a href="#">148</a>
Figure D 2.11. Cloud effect for the Crommelynck 3L pyrheliometer. ....	<a href="#">148</a>
Figure D 2.13. Cloud effect for the NIP pyrheliometer. ....	<a href="#">149</a>
Figure D 2.12. Cloud effect for the KIPP pyrheliometer. ....	<a href="#">149</a>
Figure G 1. Sample log sheet from the University of Calgary. ....	<a href="#">155</a>
Figure G 2. Sample log sheet from the NREL HBCU solar radiation network. ....	<a href="#">156</a>
Figure G 3. Sample log sheet from the Canadian BSRN site. ....	<a href="#">157</a>
Figure J 1. A BSRN station and the WRMC. ....	<a href="#">172</a>

## List of Tables

Table 1.1. BSRN Stations .....	<a href="#">3</a>
Table 1.2. List of site evaluation criteria .....	<a href="#">6</a>
Table 2.2. Recommended measurement requirements for ancillary meteorological variables .....	<a href="#">14</a>
Table 3.1. Topography types used in archive site identification .....	<a href="#">18</a>
Table 3.2. Surface types used in archive site identification .....	<a href="#">20</a>
Table 4.1. Optimized shade geometry for common instruments. The optimization considers solar aureole conditions, solar elevation and instrument characteristics (courtesy of G. Major and M. Putsay) .....	<a href="#">37</a>
Table 4.2. Advantages and disadvantages of common solar tracking instruments. ....	<a href="#">43</a>
Table 7.1. Spectral passband information for BSRN aerosol optical depth measurements .....	<a href="#">55</a>
Table 7.2. Information that is required by the archive to calculate AOD from transmission data. ....	<a href="#">62</a>
Table 7.3. Information required by the archive .....	<a href="#">63</a>
Table B 1.1. Pyranometer specification list from ISO 9060. ....	<a href="#">89</a>
Table B 1.2. Pyrheliometer specification table from ISO 9060. ....	<a href="#">90</a>
Table B 5.1. Optical characteristics of typical instrument. ....	<a href="#">108</a>
Table C 2.1. Geometrical data of diffusometers. ....	<a href="#">117</a>
Table C 2.2a. Diffusometer irradiances in $W m^{-2}$ . ....	<a href="#">120</a>
Table C 2.2b. Pyrheliometer irradiances in $W m^{-2}$ .....	<a href="#">121</a>
Table C 2.3. Comparison to the standard group. ....	<a href="#">121</a>
Table C 3.1. Direct radiation ( $W m^{-2}$ ) for the 10 sky functions. ....	<a href="#">125</a>
Table C 3.2. Circumsolar irradiances ( $W m^{-2}$ ) on the pyrheliometric sensors from the part of the sky, $z > 0.8$ deg. ....	<a href="#">126</a>
Table C 3.3. Pyranometer characteristics. ....	<a href="#">126</a>
Table C 3.4. Original and “optimal” arm length values (mm) for existing BSRN diffusometers. ....	<a href="#">127</a>
Table C 3.5. Values of original and “optimal” radii (mm) of shading disk or sphere for the existing BSRN diffusometers. ....	<a href="#">127</a>
Table C 3.6. Optimal geometric parameters (mm) of diffusometer for the considered pyranometer-pyrheliometer pairs. ....	<a href="#">128</a>
Table C 4.1. Sky irradiances expected from $0^\circ$ to $z_1$ from the centre of the sun under various solar zenith angles ( $W m^{-2}$ ). ....	<a href="#">132</a>
Table F 1. Typical specifications for the three different types of data acquisition systems available for the measurements of basic BSRN variables. ....	<a href="#">152</a>

# Baseline Surface Radiation Network Operations Manual (Version 2.1)

## 1.0 Introduction

The determination of a global climatology of the radiation budget at the surface of the Earth is fundamental to understanding the Earth's climate system, climate variability and climate change resulting from human influence. Global estimates of the surface radiation budget cannot be inferred reliably from satellite observations without high accuracy surface-based measurements at various sites in contrasting climatic regions for calibration and validation. Long-term observations of the same accuracy are also required to assess trends within climatic regions. Such measurements are essential in assessing theoretical treatments of radiative transfer in the atmosphere, verifying climate model computations, and for studying trends in surface radiation at scales smaller than normally associated with climatic regions.

To meet these requirements, the World Climate Research Programme (WCRP), jointly sponsored by the World Meteorological Organization (WMO), the International Council of Scientific Unions (ICSU) and the Intergovernmental Oceanographic Commission (IOC) of UNESCO initiated (and is organizing the implementation of) the Baseline Surface Radiation Network (BSRN). The goal of this network is to provide continuous, long-term, frequently sampled, state-of-the-art measurements of surface radiation fluxes adhering to the highest achievable standards of measurement procedures, calibration and accuracy. Many nations have expressed strong interest in participating in the BSRN and a range of stations as diverse as the Arctic, mid-latitude forested and plain areas, high mountain regions, tropical rainforest, desert, tropical islands have been established or are in the process of being installed. Figure 1.1 and Table 1.1 provide a list of locations of operating and potential BSRN stations. A continuously updated listing of sites can be found on the BSRN Archive website [www.ethz.ch](http://www.ethz.ch).

The operation of each station, or group of stations, is managed by a qualified scientist who has expertise in the measurement of radiation. Some sites have been specifically established for making measurements to determine local climate trends and provide accurate ground-truth for satellite observations. Other sites have been observing radiation components for years, but have been enhanced to meet the accuracy and resolution objectives of the BSRN. Some sites were made part of the BSRN because of their importance with respect to climate or geography although they did not fully conform to the standards set out by the BSRN at the time. These observatories were given until 1997 to upgrade to meet the specifications as originally adopted and then set forth in the

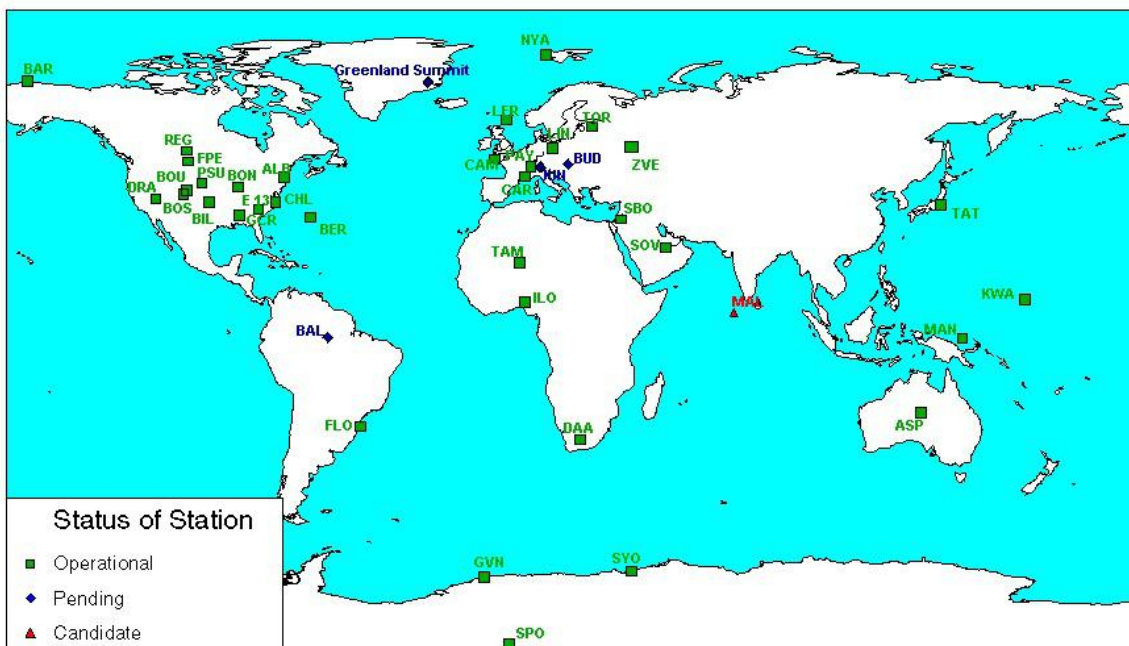

Figure 1.1. Map of BSRN sites.

implementation documentation. Whether a site is new or has been in operation for many years, operators and scientists can learn from each other to improve the measurement of surface radiation budget parameters at their own observatories.

The purpose of this manual is to provide a standardized guide to measurement techniques for all stations involved in the programme based on the experiences gained from a variety of researchers and site scientists. Recognizing that site-scientists are responsible not only to the BSRN, but to their own agencies, some of the guidelines presented in this manual may not be implemented fully. Others, because of climatic conditions, may need to exceed the specifications presented. As stated throughout the manual, the goal of the BSRN is to obtain radiation and ancillary measurements of the highest quality possible. This requires that each station manager adapt the techniques presented in the manual to the station for which they are responsible.

## 1.1 Overall goals and purpose of the BSRN

The original concept for the BSRN developed from the needs of both the climate change and satellite validation communities. The initial plan for a global network of radiation stations was developed by the WCRP Working Group on Radiative Fluxes (WGRF) in 1989, and refined at two workshops on the implementation of the BSRN, the first in Washington, DC, USA in December 1990, and the second in Davos, Switzerland in August 1991. The formal goals and objectives were set down as follows:

- provide data for calibrating satellite-based estimates of the surface radiation budget (SRB) and radiation transfer through the atmosphere
- monitor regional trends in radiation fluxes at the surface.

With the important contribution to global climate research made by the BSRN, it is emphasized that countries assuming the responsibility of operating a BSRN station will benefit significantly from having a reference surface radiation measurement station, especially in the context of national efforts to exploit environmentally clean renewable energy resources and, to some extent, in enhancing agricultural production. These issues have increased in importance with discussions in many nations on the importance and impact of the Kyoto Protocol. The measurements from a BSRN station are also a key element in monitoring national and regional climate variations, and in assessing the associated economic implications. In countries where radiation networks already exist, the instrumentation and operational procedures developed for the BSRN can be used as effective arguments to upgrade equipment and methods of observation, and to enhance calibration traceability to the World Radiation Centre. In summary, BSRN data sets have a wide range of applications beyond climate research.

Location of Operating and Planned BSRN Stations					
Symbol	Station Name	Sponsor	Latitude	Longitude	Status
TAM	Tamanrasset	Algerie	22° 47' N	5° 51' E	Operational
ASP	Alice Springs	Australia	23° 42' S	133° 52' E	Operational
BAL	Balbina	Brazil	3° 10' S	60° 00' W	Operational
FLO	Florinopolis	Brazil	27° 32' S	48° 31' W	Operational
REG	Regina	Canada	50° 12' N	104° 43' W	Operational
TOR	Toravere Observatory	Estonia	58° 16' N	26° 28' E	Operational
CAR	Carpentras	France	44° 03' N	5° 02' E	Operational
GVN	Georg von Neumayer, Antarctica	Germany	70° 39' S	8° 15' W	Operational
LIN	Lindenberg	Germany	52° 13' N	14° 07' E	Operational
NYA	Ny Ålesund, Spitsbergen (N)	Germany/Norway	78° 56' N	11° 56' E	Operational
LER	Lerwick, Shetland Islands	Great Britain	60° N	1° W	Operational

Location of Operating and Planned BSRN Stations					
Symbol	Station Name	Sponsor	Latitude	Longitude	Status
CAM	Camborne	Great Britain	50° 13' N	5° 19' W	Operational
BUD	Budapest-Lorinc	Hungary	47° 50' N	19° 05' E	Pending
SBO	Sede Boqer	Israel	30° 52' N	34° 46' E	Operational
TAT	Tateno	Japan	36° 03' N	140° 08' E	Operational
SYO	Syowa, Antarctica	Japan	69° 00' S	39° 35' E	Operational
MAL	Maldives	Maldives/United States	5° N	73° E	Candidate
ILO	Ilorin	Nigeria/United States	8° 32' N	4° 34' E	Operational
ZVE	Zvenigorod	Russia	55° 41' N	36° 46' E	Operational
SOV	Riyadh	Saudi Arabia	24° 39' N	48° 46' E	Operational
DAA	De Aar	South Africa	30° 40' S	23° 59' E	Operational
	Greenland Summit	Switzerland	72° 34' N	28° 29' W	Pending
PAY	Payerne	Switzerland	46° 49' N	6° 36' E	Operational
JUN	Jungfrauoch	Switzerland	46° 33' N	7° 59' W	Pending
ALB	Albany, New York	United States	42° 42' N	73° 50' W	Operational
BAR	Barrow	United States	71° 19' N	156° 24' W	Operational
BER	Bermuda	United States	36° 16' N	64° 20' W	Operational
BIL	Billings, ARM/CART, OK	United States	36° 36' N	97° 29' W	Operational
BON	Bondville	United States	40° 06' N	88° 37' W	Operational
BOU	Boulder	United States	40° 03' N	105° 00' W	Operational
BOS	Boulder SURFRAD	United States	40° 08' N	105° 14' W	Operational
CHL	Chesapeake Lt. Station, Virginia	United States	36° 54' N	75° 42' W	Operational
DRA	Desert Rock, SURFRAD, PA	United States	36° 38' N	116° 01' W	Operational
FPE	Fort Peck	United States	48° 31' N	105° 12' W	Operational
GCR	Goodwin Creek	United States	34° 15' N	89° 52' W	Operational
KWA	Kwajalein, Marshall Islands	United States	8° 43' N	167° 44' E	Operational
MAN	Momote, Manus Is. Papua New Guinea	United States	2° 06' S	147° 43' E	Operational
PSU	Rock Springs, SURFRAD	United States	40° 72' N	102° 04' W	Operational
E13	S. Great Plains ARM Ext. Facil. 13	United States	36° 36' N	82° 31' W	Operational
SPO	South Pole, Antarctica	United States	90° S	-	Operational

Table 1.1. BSRN Stations

## 1.2 Purpose and scope of the operations manual

In developing a network such as the BSRN, decisions need to be made on such questions as:

- what equipment should be purchased based upon the estimated accuracy, cost and maintenance requirements?
- where and for how long should the measurements be made?
- how will the instrumentation be maintained at each location?

- how will the data be quality controlled and archived?

In the BSRN, standards of measurement accuracy and archiving have been clearly defined, but the exact manner in which these standards can be achieved is left to national experts responsible for carrying out the measurements. This is because a number of commercially available instruments can perform to the desired accuracy when used properly and maintenance, quality control and data archival are determined by the circumstances of individual stations, national constraints and station procedures. This manner of developing a network has strengths and weaknesses. Its greatest strengths are the ability of regional experts to operate a station designed especially for the regime in which it exists, and that the operation of each station is closely monitored scientifically. On the other hand, achieving a high degree of standardization in overall BSRN procedures is more difficult. For example, the solutions to problems at one station may not be applicable to any other stations because of the dependency on particular equipment or national requirements. Thus, while each station may be the best possible for any given set of circumstances, the ability to transfer expertise from one station to another is more difficult.

The operations manual for such a network must use the strengths and overcome the weaknesses of this multinational approach. This manual has been developed based partly upon the following general observations:

- The individuals involved in the set-up and operation of each station are experts in the field of radiation measurement. Therefore, these scientists already know a great deal about the best way of implementing the BSRN guidelines. Such individuals often have difficulty accepting ideas other than their own, however. They will find it difficult to accept any form of standardization for the benefit of the network if it is not already part of their site plans.
- National policies or individual experiences dictate what types of instrumentation can be used. This may provide the best equipment for each individual station, but it may limit the ability of some stations to obtain certain instruments. The lack of standardized instrumentation makes the production of a single set of operating instructions for all stations impossible.
- Individual nations have varying levels of commitment to the BSRN with respect to labor and financing. This depends on both desire and capability.
- National interests will alter the focus of each station among the determination of climate change, satellite validation and experimental research pertaining to the BSRN concept.
- Station directors require freedom to alter portions of the operation manual to optimize on-site use of resources, both human and financial.

These observations are reflected in the contents of the manual in several ways:

- The description of a variety of instruments will be found. Often several different types of instruments can measure a single flux.
- Occasionally, alternate methods for accomplishing the same task are presented. Not all methods will give the same quality or results, but they are provided in recognition of the fact that some sites cannot carry out various procedures.
- Certain subjects within the operating manual have not been specified in detail because of their dependency on specialized procedures developed or on specific products. An example of this, are the programming repair and calibration of data acquisition systems.

While keeping the above considerations in mind, the manual is intended to be used by three groups of individuals:

- experts who have an established BSRN station

- experts intending to obtain the necessary resources to establish a BSRN station
- technologists involved in the construction and operation of a BSRN station.

For experts, it is hoped that the manual will provide:

- the necessary information required to obtain resources,
- the documentation required to support the establishment of a BSRN site
- information on types and manufacturers of instruments that can be used within the BSRN and that meet the guidelines on accuracy.

While none of these purposes is fulfilled in an exhaustive manner, most researchers should find the information sufficient.

The use of the manual by well-trained technologists will aid in the establishment and maintenance of a BSRN measuring program in a manner consistent with the goals and purposes of the programme. It is recognized that some of this information will need modification in a variety of ways. The simplest transformation may be into a language appropriate to those operating the site. More significant alterations may include the addition of information on particular data acquisition units or in the forms provided as guidelines for routine maintenance checks. These changes should be made in a consultative manner between the station scientist and those technologists performing the particular tasks under discussion.

The manual contains sections on sampling frequency and accuracy requirements for BSRN stations, the siting of stations, the installation of radiation instruments, solar tracking devices, data acquisition, station maintenance, radiation instrument calibration, and radiation data reduction and quality assurance procedures, as well as a variety of ancillary information in Annexes. However, it must be stated categorically that this operations manual is NOT a primer on the construction and operation of a radiation monitoring site. It is assumed that the station director has previous experience in the operation of radiation instruments. Furthermore, it is assumed that the technologists have at least a minimum of experience in operating data acquisition systems, computers and similar hardware, although not necessarily equipment specific to the measurement of solar and terrestrial radiation. The manual does provide fundamental guidance in assisting station scientists and technologists in meeting the aims, objectives and specifications of the Baseline Surface Radiation Network.

### **1.3 Specific objectives and research activities**

The specific objectives of the BSRN as found in the Washington, D.C. meeting report, are:

- to measure the surface radiation components at strategic locations with a demonstrated accuracy and precision sufficient for revealing long-term trends
- to obtain concurrent measurements of atmospheric constituents such as clouds, water vapour, ozone and aerosols that affect the radiation at the surface and at the top of the atmosphere
- to assure uniform adherence to the highest achievable standards of procedure, accuracy and calibration throughout the network.

The associated activities and research goals are:

- Site characterization: Acquisition of quantitative information on features such as nature of the surface, average cloud cover and type, aerosols, etc., that characterize the site for satellite applications
- Infrared Irradiance Measurements: Advancing state-of-the-art instrumentation and methods of observation for accurate measurement of downwelling radiance and irradiance measurements to meet Surface Radiation Budget (SRB) measurement standards

- Extended-Surface Reflectance and In Situ Measurements: development of methods for measuring surface reflectance over a larger area (e.g., 20 X 20 km) by using a tower or small aircraft, special aircraft and balloon experiments to collect *in situ* information to validate the remote sensing measurements.
- Atmospheric Inhomogeneities: studies aimed at improving the understanding and measurement of the radiative features of inhomogeneous and broken clouds
- Special Measurements: development of cost-effective instrumentation and methods for measurement of spectral ultraviolet and infrared SRB that will aid the improvement of satellite algorithm design and validation of satellite SRB determinations
- Improvement of Instrumentation: investigations to improve the design and performance of “standardized” instrumentation such as sunphotometers and pyranometers, and incorporate, improve, and develop more sophisticated remote sensing instrumentation to enhance the cloud-observing abilities of the BSRN.

Site Evaluation Criteria		
Characteristic	Locations Representing	Example Location
Radiation field values	large variability, both synoptic and seasonal scales	Siberia
Satellite algorithm performance	a range of difficulty for set retrievals	Equatorial Indian Ocean Temperate Oceania
Cloud Properties	a range of cloud types	Tropical Pacific
Climate Change	the potentially higher sensitivity of a region to changes in global climate	Antarctic coasts, Northern Canada
Satellite Coverage	a range dependence on the orbit, viewing angle, overlap regions	Spitsbergen
Unusual atmospheric phenomenon	a range of unusual atmospheric phenomenon (aerosol, clear skies, etc.)	Sahel, Tropical Pacific
Surface Cover	a range of surface cover (e.g., snow, sea ice, ocean, vegetated, desert, etc.)	South Ocean, Ice Island, Equatorial Africa
Climatic Regions	a range of climate regions (polar, tropical, etc.)	Ice Island, Central Australia, Antarctic Coast
Upwelling flux studies	areas where upwelling flux studies would be of particular value to validation because of the site qualities and in some cases the existence of SRB measurement facilities	Boulder Tower
Calibration	locations possessing uniform and high surface reflectance properties for the calibration of satellite-borne instruments	Prairie, Amazon Basin

Table 1.2. List of site evaluation criteria based upon a selection of desirable surface/atmospheric characteristics and the results of satellite algorithm performance comparisons.

- The type of geographical region where such stations would most aid the development and validation of satellite algorithms (Table 1.2) and specific research areas on instrument development and calibration were also proposed at the workshop.

While the objectives and goals have been laid down specifically for climate research, the impact of the BSRN concept is far wider than just this one community. By providing a standard means of measuring radiation to a known accuracy, other programs and countries can implement these ideas with little added effort. Other programs such as the Global Atmosphere Watch (GAW) and the Atmospheric Radiation Measurement (ARM) Program has already implemented ideas presented in the early BSRN documents. Countries presently developing radiation networks or

upgrading older networks can also benefit from results of the ongoing research conducted specifically to improve the measurement of solar and terrestrial fluxes using commercially available instrumentation. The quality control procedures outlined later in this manual and the archiving procedures presented elsewhere, can be used with little modification for many other radiation networks. These improvements in measurement techniques, quality assurance and quality control can be used for networks involved in the measurement of solar radiation for such diverse applications as passive and active solar energy utilization and cloud absorption modelling. Moreover, efforts to install networks to observe UVB and ozone could readily build on an established BSRN station designed to operate according to the highest achievable standards.

## 2.0 Sampling Frequency and Accuracy Requirements for BSRN Stations

### 2.1 Sampling Frequency

#### 2.1.1 Sampling Frequency of Radiation Measurements

The BSRN requires that all radiation variables be sampled at 1 HZ with an averaging time of one minute. The final output for each variable should consist of the one-minute mean, minimum, maximum and standard deviation. This specification is based upon the typical 1/e response time of first class pyranometers and pyrhemometers being approximately one second. Although some instruments require the measurement of more than one signal for the calculation of a specific radiation element, the archived data will consist only of the mean, minimum, maximum and standard deviation of the radiation element.

When an element requires more than one signal to be measured or the conversion from the signal to the final value of the element is non-linear, difficulties arise in providing a single true sample standard deviation for the one-minute mean value. This can be accomplished if the measurements are stored each second and the calculations done later or the data acquisition system is capable of calculating the parameter each second.

The most common radiation observation made in the BSRN that requires multiple signals is infrared irradiance, where between 2 and 5 measurements are made each second, depending on instrument type. There are two methods of data handling that provide the exact standard deviation for the flux and two methods that provide an estimate of the standard deviation if the standard deviation cannot be calculated.

- (1) Observations can be made of each of the required signals once per second and stored. Using this data, the one minute average can be calculated by applying the appropriate instrument responsivity to each voltage measurement and the appropriate effects of the case and dome temperatures. The standard deviation can then be calculated from the individually calculated flux values. The primary drawback of this method of signal processing is storage requirement associated with collecting one-second data.
- (2) With the increasing computation power of data acquisition equipment, the determination of the infrared flux can be made following the measurement of the appropriate signals. This would require the conversion of the instrument thermopile signal into a flux, and between 1 and 4 thermistor resistance measurements into temperatures and then the equivalent blackbody fluxes. This method requires the embedding of the thermopile responsivity into the data acquisition system. Many scientists are unwilling to include such information in the acquisition stage of an observation because of the risk of error and the difficulty of correcting the problem when discovered. To reduce the potential of this type of error, while maintaining the capability of calculating the standard deviation, the mean, minimum, maximum and standard deviation of each of the raw signals can be stored along with calculated infrared irradiance.

Alternatively, given the difficulty associated with observing, storing and calculating the exact standard deviation of the infrared flux, the standard deviation of the flux can be reasonably estimated based by the standard deviation of the thermopile signal. This estimate assumes that over one-minute the temperatures of the case and dome remain nearly constant and therefore do not affect greatly the overall standard deviation of the flux. This assumption is substantiated by reference to Figure 8.1 that illustrates that a 5% change in thermistor resistance alters the overall flux by less than  $\pm 1.6\%$  over an extended temperature range.

The observation of temperature using thermistor technology is illustrative of a non-linear conversion from resistance to temperature using the Steinhart and Hart equation (see Sec. 9.2.3). In cases where the one-second data is not stored or the conversion of resistance to temperature is not accomplished within the data acquisition system each second, the standard deviation of the temperature should be estimated based on the positive standard deviation

### 2.1.2 Sampling Frequency of Ancillary Measurements

At stations where the ancillary measurements are under the control of an independent agency, such as a national weather service, the frequency of the various measurements cannot often be altered. The higher the frequency the greater the usefulness of the data, up to the sampling rate of the radiation measurements. BSRN station scientists should encourage any independent collection agency to sample and record data following standard WMO procedures at the very minimum.

When automatic data logging is employed to record such variables as pressure, temperature, humidity, wind speed and wind direction, providing these data at the same frequency as the radiation data is beneficial. Stations are encouraged to obtain these observations coincidentally with the radiation measurements using a one-minute sample rate to aid in understanding the energy balance of the radiation instruments and the infrared component of the radiation balance. At a very minimum, all stations should record air temperature at the same location and at the same sampling frequency as the radiation measurements.

## 2.2 Uncertainty<sup>1</sup> of Measurements

### 2.2.1 Uncertainty in Radiation Measurements

These accuracies are based upon state-of-the-art commercially available equipment. At the onset of the BSRN programme, a table listing the uncertainties about individual flux measurements was produced (Table 2.1) that included the uncertainties thought to be achievable by 1997. These uncertainty values have been achieved using new sensors and methods of observation, some being surpassed. Nevertheless, new methods of observation are continuing to develop that will continue to decrease the overall uncertainty associated with instantaneous measurements.

Even as instrumentation and methods of observation have improved over the decade since the inception of the network, the estimate of uncertainty has become more refined. The publication of the International Organization for Standardization (ISO) *Guide to the Expression of Uncertainty Measurement*<sup>2</sup> (GUM) provides a standard method for the determination of uncertainty in measurement. National Metrology Institutions (NMI) and industrial laboratories have adopted its methodology and the BSRN recommends that all uncertainty calculations follow the procedures of the guide.

To meet and exceed these target accuracies, the measurement of each quantity will require a particular methodology of measurement. While these methodologies are not absolute in nature, they will ensure a given level of uncertainty in the measurement if followed (assuming appropriate on-site maintenance etc.). The BSRN is concerned more with meeting the target measurement uncertainty however, than the manner in which the uncertainty is met. Methods of measurement associated with these uncertainties were first published in WCRP-64, 1991. While many methodologies have not changed significantly since the inception of the programme, several measurement techniques have improved. Those that have not changed are repeated verbatim in this manual.

#### 2.2.1.1 Direct Solar Irradiance

The target uncertainty for measurement of direct solar irradiance in the BSRN is 1% (or  $2 \text{ W m}^{-2}$  as the minimum deviation from the "true" value as reflected in the uncertainty of the World Radiometric Reference). For the continuous measurements used in providing the mean value over one-minute, a normal incidence pyrheliometer (nip<sup>3</sup>) or similar is recommended.

---

<sup>1</sup> Uncertainty is defined as a parameter associated with the result of a measurement, that characterizes the dispersion of the values that could reasonably be attributed to the measurand. Former BSRN publications have termed this accuracy. The terminology has been changed to follow the ISO guidelines. Accuracy is a more general terminology that expresses a variety of ideas, many of which cannot be quantified.

<sup>2</sup> ISO, 1993: *Guidelines for the Expression of Uncertainty Measurement*. First Edition.

<sup>3</sup> nip (lowercase) is used as an acronym and is not to be confused with NIP™ of Eppley Laboratories.

BSRN Measurement Uncertainty			
Quantity	1991*	1997 Target**	2004 Target†
1. Direct Solar Irradiance		1% or 2 W m <sup>-2</sup>	0.5% or 1.5 W m <sup>-2</sup>
2. Diffuse Radiation	10 W m <sup>-2</sup>	4% or 5 W m <sup>-2</sup>	2% or 3 W m <sup>-2</sup>
3. Global Radiation	15 W m <sup>-2</sup>	2% or 5 W m <sup>-2</sup>	2% or 5 W m <sup>-2</sup>
4. Reflected Solar Radiation	15 W m <sup>-2</sup>	5%	3%
5. Downwelling Infrared Radiation	30 W m <sup>-2</sup>	5% or 10 W m <sup>-2</sup>	2% or 3 W m <sup>-2</sup>
6. Upwelling Infrared Radiation	30 W m <sup>-2</sup>	5% or 10 W m <sup>-2</sup>	2% or 3 W m <sup>-2</sup>
	* from WCRP-54, Mar 1991	** from WCRP-64, Nov 1991	† estimates based on current research

Table 2.1. Uncertainty requirements for the Baseline Surface Radiation Network radiation fluxes. Where values are given in percent and absolute, the latter are the minimum deviation from the “true” value measured by the instrument for any irradiance.

Experiments have shown that for many nip instruments the uncertainty associated with the noise of these instruments exceeds the uncertainty requirements for direct solar irradiance measurements. Therefore, an absolute cavity radiometer (ACR) should be used in parallel to “calibrate” the normal incident pyr heliometer quasi-continuously (every 5-60 minutes, if the normal direct beam intensity ( $I$ ) > 400 W m<sup>-2</sup>).

Pyr heliometers normally operate with a window that blocks part of the solar infrared signal. Similarly, many ACRs when used as all-weather instruments also have a window to protect the instrument from the elements. These windows must be made of the same material to ensure that differences in window transmittance are not ‘calibrated’ into the measured irradiance and thus increase the uncertainty of the measurement. To obtain higher quality measurements that include the signal from the infrared portion of the solar spectrum, the instrument can be operated without a window or with a window made of a material that has flat transmission characteristics from approximately 290 nm to 4000 nm (> 99% of the solar spectrum). Recent advances in the construction of all-weather enclosures, both windowless and those using sapphire or calcium fluoride windows and special heating and ventilation systems have reduced the dependence on simple thermopile pyr heliometers that require frequent comparison with fair-weather ACR instruments. It is recommended that an all-weather ACR be used continuously with a standard pyr heliometer used to fill ‘data gaps’ during the period when the ACR is in calibration mode.

Caution must be exercised if a windowless ACR is to be operated continuously. The minimum protection required is to house the instrument in a ventilated housing. The opening aperture of the housing should be a minimum of 10 radiometer-opening-aperture diameters distant from the entrance aperture of the enclosed ACR and have a diameter no greater than twice the field of view of the ACR. Care must be taken when ventilating the instrument so that no venturi effects are created that might alter the thermal equilibrium of the instrument. In areas where severe weather conditions are prevalent, systems that include a means of closing the opening aperture are required.

When using a calcium fluoride window, yearly inspections are recommended to ensure the integrity of the flat because of the anhydrous nature of the material. In very humid or wet environments, inspections of the flat should be made monthly. To protect the instrument from precipitation, an automatic cover triggered by a rain sensor can be installed.

Experiments have also shown that maintaining the temperature of the thermopile on certain ACR instruments, when used in an all-weather mode, further enhance performance.

A solar tracker with an accuracy of  $\pm 0.10^\circ$  or better, is needed to accommodate the pyrheliometer, the ACR and, during calibrations, a second ACR. It is recommended that the tracker pointing be monitored using a four-quadrant sensor because pointing accuracy is important in determining the quality of the direct beam measurement. The sampling rate should be the same as that of the instruments attached to the tracker. A variety of high-quality trackers are now available that use four-quadrant sensors for actively positioning the tracker on the solar beam during periods of high irradiance and a solar position algorithm during low intensity conditions.

The parameters to be monitored are: output of the pyrheliometer thermopile; outputs of the ACR (U, I or thermopile signals for a passive instrument); body temperatures of the pyrheliometer and ACR; output of the four-quadrant sensor. Only the values associated with the calculated irradiance (mean, maximum, minimum and standard deviation) are required by the BSRN archive. All other raw data should be archived at the centre responsible for the measurements.

#### 2.2.1.2 Diffuse Radiation

The original instrument configuration associated with the BSRN target uncertainty of 4% ( $5 \text{ W m}^{-2}$ ) was a ventilated pyranometer with a sensor to monitor the instrument thermopile temperature (to be used to correct for temperature-related changes in thermopile responsivity and thermal offset). Shading of the instrument from the direct sun was to be by a shading disk. The shade geometry of the combination of the sensor and the disk was to replicate the geometry of the direct beam sensor when pointing toward the zenith ( $5^\circ$  full-angle from the centre of the detector)<sup>4</sup>. The instrument's sensor and dome must be completely shaded. Incorrect geometry alone can lead to errors of up to  $5 \text{ W m}^{-2}$  depending on instrumentation and atmospheric conditions.

A relationship has been shown between pyranometer thermal offsets and diffuse irradiance that can significantly affect the quality of the measurement<sup>5</sup>. A possible solution to overcome the offset problem is to use a 'black and white' type pyranometer (B&W) for the measurement of diffuse radiation. This type of instrument does not exhibit the thermal offset of 'black' thermopile instruments because both hot and cold junctions are exposed to the same thermal regime. B&W instruments, currently, do not have the same optical qualities (spectral and directional) as the black thermopile instruments recommended for use at BSRN stations and cannot be used for the measurement of global radiation. Using a B&W instrument for the measurement of diffuse irradiance would therefore mean a second type of instrument would have to be used for the global irradiance measurement, which may increase the overall uncertainty of the three-component measurements.

Research is presently ongoing to determine whether a correction factor can be applied to the 'black' pyranometer thermal offset. In Section 9.2.2 experimental methods of correcting this offset are presented. Further research continues into the design of a 'black' pyranometer that does not exhibit thermal offset. Several instruments that use other technologies (e.g., PRT) are available that do not exhibit offset problems associated with radiative cooling.

The BSRN has yet to recommend a standard method of correcting for thermal offset or selecting a particular type of instrument for measuring diffuse irradiance. A careful uncertainty analysis of any diffuse system will determine the quality of the measurement if each component is properly addressed.

The parameters to be acquired are: output of pyranometer thermopile; pyranometer body temperature. Only the values associated with the calculated irradiance (mean, maximum, minimum and standard deviation) are required by BSRN archive. All other raw data should be archived at the centre responsible for the measurements.

---

<sup>4</sup> Major, G., 1992: Estimation of the error caused by the circumsolar radiation when measuring global radiation as a sum of direct and diffuse radiation. *Solar Energy*, 48. (See Table 4.1 for common combinations of pyrheliometers and pyranometers.)

<sup>5</sup> Bush, B.C., F.P.J. Valero and A.S. Simposn, 2000: Characterization of thermal effects in pyranometers: A data correction algorithm for improved measurement of surface insolation. *Jour. Atmos. Ocean. Tech.*, 17, 165 - 175.

### 2.2.1.3 Global Radiation

BSRN target uncertainty is 2% ( $5 \text{ W m}^{-2}$ ). Although the global radiation may be determined as a sum of direct and diffuse irradiance, a direct measurement will be made with a ventilated pyranometer (the same instrument type as for diffuse radiation) to provide a basis for quality control; including instrument characterisation and calibration (see Section 8.3 - Calibration procedures).

The same thermal offset issues associated with the measurement of diffuse irradiance must also be considered for global irradiance. The difference in the magnitude of the irradiance signals (global vs. diffuse) reduces the overall relative uncertainty associated with thermal offset for global irradiance measurements.

Parameters to be acquired are: output of pyranometer thermopile; pyranometer body temperature. Only the values associated with the calculated irradiance (mean, maximum, minimum and standard deviation) are required by BSRN archive. All other raw data should be archived at the centre responsible for the measurements.

### 2.2.1.4 Reflected Solar Radiation

This measurement, required at BSRN stations undertaking the "expanded measurement" programme, will be done with the same type of ventilated pyranometer as for diffuse and global radiation. It is suggested that a horizontal shadowband be used to protect the instrument dome from reflecting direct solar radiation onto the thermopile at low solar elevation. The angle sustained should be less than  $5^\circ$  (i.e., covering nadir angles  $85^\circ$  to  $90^\circ$ ). With the exception of frost on other material on the dome that would enhance the internal reflection problem, the error due to internal reflection or the direct beam grazing the thermopile on a level instrument is estimated to be  $<1 \text{ W m}^{-2}$ . The minimum height above the surface for the measurement is 30 m so that the observations represents the reflectance of the surrounding area. The actual height of the downfacing centre should be reported to the archive.

Parameters to be acquired are: output of pyranometer thermopile; pyranometer body temperature. Only the values associated with the calculated irradiance (mean, maximum, minimum and standard deviation) are required by BSRN archive. All other raw data should be archived at the centre responsible for the measurements.

### 2.2.1.5 Downwelling Infrared Radiation

BSRN target uncertainty is 5% or  $10 \text{ W m}^{-2}$ , whichever is greater. Significant evidence suggests that a pyrgeometer with a hemispheric silicon dome is negatively impacted by solar radiation through dome heating<sup>6</sup>. The BSRN recognizing this fact determined that downward infrared irradiance should be measured with a shaded and ventilated pyrgeometer. Furthermore, it noted that, if using an Eppley PIR, the battery circuit must be disconnected and the thermistor temperatures directly measured. It was determined that a "modified PIR" pyrgeometer (Eppley) with three dome temperature sensors at  $45^\circ$  (but without a battery circuit)<sup>7</sup> was capable of measuring downwelling infrared radiation to the target uncertainty. Although not normally used in an unshaded mode, this modified instrument is designed to measure infrared radiation in full sunlight. Furthermore, it was recognized that a shaded and ventilated unmodified Eppley pyrgeometer could provide nearly the same quality of measurement. Recently, other manufacturers have begun producing pyrgeometers that may also be suitable for use in BSRN stations.

---

<sup>6</sup> Alados-Arboledas, L., J. Vida and J.I. Jiménez, 1988: Effects of solar radiation on the performance of pyrgeometers with silicon domes. *Jour. Atmos. Ocean. Tech.*, 5, 666 - 670.

Udo, S.O., 2000: Quantification of solar heating of the dome of a pyrgeometer for a tropical location: Ilorin, Nigeria. *Jour. Atmos. Ocean. Tech.*, 17, 995 - 1000.

<sup>7</sup> Philippona, R. C. Fröhlich and Ch. Betz, 1995: Characterization of pyrgeometers and the accuracy of atmospheric long-wave radiation measurements. *Appl. Optics*, 34, 1598 - 1605.

A recent comparison<sup>8</sup> indicates that the uncertainty associated with infrared measurements approximate the BSRN target values when the instrument responsivities used are those of the independent calibration laboratories. When using field calibrations, one-hour mean irradiances are found to compare to approximately  $1 \text{ W m}^{-2}$  for night conditions and  $2 \text{ W m}^{-2}$  during daylight hours. These differences are attributable to different methods used in the determination of the flux from the instrument outputs. The most significant finding of the comparison is the need to develop an absolute calibration method that will eliminate the large uncertainties associated with laboratory calibrations.

Parameters to be acquired are: outputs of pyrgeometer thermopile; instrument body temperatures and dome temperatures of the pyrgeometer for instruments requiring such measurements. Only the values associated with the calculated irradiance (mean, maximum, minimum and standard deviation) are required by BSRN archive. All other raw data should be archived at the centre responsible for the measurements.

#### 2.2.1.6 Upwelling Infrared Radiation

This measurement, required at BSRN stations undertaking the expanded programme, will be done with the same type of ventilated pyrgeometer used for observing the downward infrared irradiance. It is suggested that a horizontal shadow band be installed to protect the instrument dome from heating due to direct solar radiation when the sun is at low solar elevation. The angle sustained will be less than  $5^\circ$  (i.e., covering nadir angles  $85^\circ$  to  $90^\circ$ ). The instrument should be mounted on a tower with a minimum height of 30 m to provide a representative measurement of the surrounding area. The actual height of the downfacing sensor should be reported to the archive.

Parameters to be acquired are: outputs of pyrgeometer thermopile, and instrument body and dome temperatures for pyrgeometers requiring such measurements. Only the values associated with the calculated irradiance (mean, maximum, minimum and standard deviation) are required by BSRN archive. All other raw data should be archived at the centre responsible for the measurements.

#### 2.2.2 Accuracy of Meteorological Measurements

The requirement of meteorological observations at or near BSRN sites infers that certain levels of confidence must be placed in the measurements. Most of these observations are made at stations that are part of national observing networks where changing instruments to meet BSRN needs are difficult or even impossible. In such cases, the site scientist should determine the uncertainty of each of these observations either directly, or by consulting the appropriate experts, and provide it to the BSRN Archive.

Where instrumentation is obtained specifically for the measurement of meteorological variables at a BSRN site, research quality instrumentation should be obtained. Table 2.2 presents a guideline on the uncertainty and resolution for some typical measurement fields. Experts in the appropriate measurement fields familiar with the climatology of the BSRN station should be consulted on specific instruments.

### 2.3 Accuracy of Data Acquisition Equipment

#### 2.3.1 Time

Time is critical with respect to the frequency of the measurement sequence and the absolute time of the observation. This requires that the clocks for all observations be maintained to within  $\pm 1\%$  of the averaging period used for the most frequent measurements. For a one minute average this equates to a time accuracy of 0.6 seconds. Because of the difficulty in manually setting a clock to

---

<sup>8</sup> Philipona, R., E.G. Dutton, T. Stoffel, J. Michalsky, I.Redá, A. Stifter, P. Wendling, N. Wood, S.A. Clough, E. J. Mlawer, G. Anderson, H.E. Revercomb and T.R. Shippert, 2001: Atmospheric longwave irradiance uncertainty: Pyrgeometers compared to an absolute sky-scanning radiometer, atmospheric emitted radiance interferometer, and radiative transfer model calculations. *J. Geophys. Res.*, 106 (D22) 28129 - 28141.

better than one second, this time accuracy was relaxed to one second at the BSRN Science and Review Workshop (Boulder, Colorado, USA, 12-16 August, 1996).

The automatic determination of time to within one second can be easily achieved on portable computers using one of three common methods: (1) time-synchronization with the Global Positioning System (GPS) satellites; (2) conversion of radio frequency time signals sent out by national standards agencies; and (3) through time updates obtained via the internet.

Computer clocks can be synchronized to within 2 milliseconds of UTC with simple and inexpensive GPS systems that consist of a small antenna (< 100 mm diameter) and a decoder box that can be plugged into the serial port. More expensive bus systems can increase the accuracy of the synchronization to better than 1 microsecond. The need for an antenna and a view of the sky, may reduce the applicability of such systems in built-up areas, or where the unit is deep within a building complex. In certain regions of the world (North America, Australia, China) a similar system has been developed, CDMA (indirect GPS) that operates through cellular networks and is maintained by the cellular providers. CDMA, where available, is similar to GPS, but uses a much smaller integrated antenna and will work within office complexes. The time is kept to an accuracy of better than 10 microseconds.

<b>Typical Meteorological Measurement Field Specifications</b>		
Measurement	Resolution	Uncertainty
Air Temperature	0.1 °C	±0.3 °C
Dew Point Temperature	0.1 °C	±0.5 °C
Soil Temperature	0.1 °C	±0.3 °C
Relative Humidity	1%	±7%
Wind Speed	0.5 ms <sup>-1</sup>	±5% or ± 2 ms <sup>-1</sup>
Wind Direction	5°	±10°
Accumulated Precipitation	0.2 mm	greater of ±0.2 mm or ± 2% of total
Precipitation Intensity	0.2 mm h <sup>-1</sup>	greater of ±0.2 mm h <sup>-1</sup> or ± 2% of total
Snow Depth	1 mm	greater of ± 10 mm or ±1% of value
Atmospheric Pressure	0.1 hPa	±0.5 hPa

Table 2.2. Recommended measurement requirements for ancillary meteorological variables.

Many national metrology institutes (NMI) transmit time signals, based upon the national time standard, at short-wave radio frequencies. These radio time signals can be received thousands of kilometres from the transmitter, depending on ionospheric conditions. With the proper decoding and correction for time delays, the accuracy of the time signal can be better than 1 ms. Like the GPS system, short-wave radio receivers require external antennas. While radio signals are as accurate and less expensive than GPS systems, and more accurate than most internet systems, the radio time signal is losing popularity over the ease of use of GPS and internet systems.

Computer time-synchronization has advanced rapidly since the onset of the modem communication and the internet. The time obtained in this manner is not usually as accurate as the GPS and radio time signals, the need to synchronize a clock to better than one second can normally be accomplished through these methods. Many NMIs provide analog-modem dial-up links and the associated software required to set a local computer clock to UTC. The software can translate simple telephone codes that allow corrections to be made for the signal propagation delay. Using this method, computer clocks can be set to within several milliseconds of UTC. New, high speed modems that use digital processing can add a variable delay of up to 140 ms and a 20 ms jitter beyond the delay due to signal propagation. Further uncertainties associated with the use of modems using digital technology. These telephone services are also degraded when

communications are made via satellite links (long-distance services), but again, correction can be applied. Obtaining a true time via the internet is more difficult than with modems because of the increased variability in response times of the service. To overcome some of the variability associated with these delays, the Network Time Protocol (NTP) was developed. The advantage of NTP is its ease of use and its ability to be used on most computer platforms. Both the NTP service and the software required to use it is freely available on the worldwide web, along with details of its operation<sup>9</sup>. It must be noted that the NTP service will not operate correctly if the computer being updated is behind a firewall, unless the firewall is set up to allow NTP packets through. NTP is a very effective means of standardising computers on a local area network. For remote locations, a high quality GPS system associated with the network server and NTP can synchronize the LAN to better than 1 ms of the GPS time base.

These signals can either be incorporated directly into more advanced data acquisition systems or set on a daily basis for less advanced systems or externally controlled data acquisition system. The software operating many PC Card Data Acquisition Systems (DAS) uses the computer clock for time information. Therefore, maintaining the computer clock time as accurately as possible is essential. For a PC with a time gain of 10 seconds per day, the clock would require automatic updating approximately once each hour. Communication with many new external DAS can be accomplished through local area network protocols, especially Internet Protocol (IP) addressing that provides an easy means of ensuring that all systems, computers and dataloggers, maintain time precisely.

For data acquisition systems with internal time keeping, the same clock correction must be maintained for the relative sampling rate, while the absolute time can be corrected during data processing.

### 2.3.2 Data Acquisition System Accuracy

The specification for data acquisition system requirements for BSRN radiation measurements is set forth in the report of the WCRP BSRN Implementation Workshop, Davos, Switzerland, 6 - 9 August 1991. Uncertainty of the complete system (digital voltmeter (DVM), scanner (multiplexer) and cabling) was set as  $\pm 0.01\%$  of the reading or  $\pm 1 \mu\text{V}$ , whichever is greater. If the overall accuracy of the data acquisition system is greater than 10% of the accuracy required for the observation (e.g.,  $1 \text{ W m}^{-2}$  for an instantaneous uncertainty of  $10 \text{ W m}^{-2}$ ), then a high quality preamplifier should be used. If such an amplifier is required, it should be placed as close to the signal transducer as possible so that line noise is not also amplified, as it would be if the amplifier were associated with the DAS. Care must be taken to ensure the temperature stability of the amplifier, either through amplifier selection or temperature control, so that temperature influences do not increase significantly the uncertainty in the measurement.

Each instrument should be scanned at least once per second with the analog signals integrated to provide one-second values. On those systems where integration time is programmable, the shortest period to be used for sampling of radiation signals is one power line cycle (PLC).

Sample averaging and special filtering techniques are required when employing many new high-speed DAS systems, especially those that are directly connected to a computer bus, to reduce uncertainties associated with electromagnetic noise.

While the primary aim of the BSRN is to obtain accurate radiation fluxes, the accuracy of the data acquisition system used in the collection of ancillary data should be commensurate with the general aims of the program. Therefore, ancillary measurements should be sampled and recorded following the same principles as applied to the radiation observations.

---

<sup>9</sup> Three locations where further information on time synchronization can be found are:  
(1) NIST: <http://www.boulder.nist.gov/timefreq/service/its.htm>  
(2) PTB: [http://www.ptb.de/en/org/q/q4/q42/ntp/\\_ntp\\_main.htm](http://www.ptb.de/en/org/q/q4/q42/ntp/_ntp_main.htm) and  
(3) Time Synchronization Server: <http://www.eecis.udel.edu/~ntp/index.html>.

### 3.0 The BSRN Site

#### 3.1 Geographic Location of Site

##### 3.1.1 General Considerations

In selecting sites for the Baseline Surface Radiation Network, the objective is to choose a site which is representative of a relatively large area (greater than 100 km<sup>2</sup>) with common features. The site location should be consistent with the intended purpose for which the observations are being made. For example, a site which is representative of a unique microclimate within a large region should not be selected as a site for regional climate observations. In order to achieve this goal, it is necessary to select sites that are not influenced by small-scale topographic or man-made features that are unique to the site but not common to the area for which the data are required. Conversely, if the area is mountainous and contains numerous lakes, then the site should be selected to reflect the effect of these features.

Great care must be taken in determining the exact placement of a radiation site so that local influences do not impact the long-term measurement goals of the BSRN. While it is impossible to predict future developments, the selection of the location should proceed only after a careful survey of the area. Before a station is constructed, local planners should be consulted to determine whether or not future developments, either commercial or residential, will interfere with the observation site. Some localities have developed multi year land use documents that provide information on the overall growth pattern of entire regions. These may provide information on whether or not a long-term monitoring site will be compromised because of excessive development over the decades following site construction. It is recommended that land use plans for an area of up to a 20-km radius be reviewed before a final decision is made on the location of a long-term monitoring station. Local authorities must also be consulted to ensure that the site can be constructed and whether or not any changes are necessary in the official plans before construction of a monitoring laboratory begins. Similarly, BSRN stations should not be built on or near airports or near a single major industrial source because of the possibility of constructing a long data set that reflects changes in airport traffic or air pollution control legislation. In rural areas, care should be taken to ensure that significant land-use changes are not planned. The removal of forests or the change in farming techniques may have significant effects on the albedo and the amount of natural contaminants. Both of these could mask any climate trends that might be global or regional in nature.

While changes in the view of the horizon are less critical if they are small, potential changes should be considered before the location of a site is selected. It must be remembered that in urban areas, unless specific allowances are in place, buildings, not yet constructed, may tower above the site in future years and force the closure of the observatory. Even trees grow over decades and can become a significant obstruction, if they cannot be trimmed or removed.

Generally, sites will yield more representative data where the terrain is flat and free from obstruction. In forested, mountainous, but not built-up areas, moderately sheltered sites which meet the minimum distances from obstructions can be selected because they will yield data that are representative of that particular region. Wherever the site is located, it must be representative of the surrounding region.

In general, BSRN stations should avoid locations that are:

- (1) not representative of the surrounding area (approximately 100 km<sup>2</sup> for the local area and 10,000 km<sup>2</sup> for regional representativeness);
- (2) near areas that will adversely affect the radiation or ancillary measurements because of pollution sources, areas of unnatural reflectance or areas where the microclimate is altered by irrigation or other human modifications;
- (3) near major roadways;
- (4) near airports;
- (5) where there is excessive human or animal traffic;

- (6) near vehicle parking areas; and
- (7) where heat is exhausted by vehicles or buildings.

Conversely, BSRN stations must be located where facilities exist, preferably on a full-time 24-hour basis. Ideally, the site should be co-located with a synoptic station and within 50 km of an upper air station.

### 3.1.2 Horizon

The ideal site for the measurement of solar and terrestrial radiation for meteorological purposes is one that has a completely flat horizon. The WMO Guide to Meteorological Instruments and Methods of Observation (WMO No. 8) recommends that if possible no obstruction should be present, particularly within the azimuth range of sunrise and sunset over the year (see Annex I for a solar position algorithm). In cases where obstructions do occur, the instrument should be located where these subtend an elevation angle of less than 5° to minimize their effects. The total diffuse radiation received by a surface from elevation angles of less than 5° accounts for only about 1% of the total global radiation. The determination of the change in radiation fluxes with respect to changing climate, and the use of surface measurements to test and ground-truth satellite retrieval algorithms do not require strict adherence to this guideline when distant topography is considered. In the latter case, measurements in areas of complex topography are required to determine the capabilities of the retrievals.

While the distant horizon may be influenced by topography, the local horizon should be as clear as practically possible. A distance of 12 times the height of any object to the location of the sensor will ensure that the elevation of the object is less than 5° above the horizon. The site should be located such that all objects are to the poleward side of the installation and do not interfere with the direct beam radiation at any time during the year. The instruments should be removed, as far as is practical, from any highly reflective objects. Where a site is to be developed in a built-up area, the sensors can be located on the roof of a building to overcome problems with the local horizon.

While antennas and other slender objects should be avoided, their effect is minimal and can be endured if they are less than 1° wide, and do not block the direct beam radiation during any time of the year.

### 3.1.3 Latitude, Longitude, Elevation

A detailed description of the measurement site and its surroundings is probably one of the most significant pieces of metadata provided to other researchers. It is of utmost importance to describe the site and its surroundings, not only in terms of latitude, longitude and elevation, but also with respect to the topography and land use surrounding the measurement location. One must consider this description in terms of the pixel size of present-day satellite measurements and the potential for influences on the radiation regime due to multiple scattering.

The first and foremost information required are the geographic coordinates of the site: latitude, longitude and elevation above mean sea level (msl). These normally can be obtained from high-quality topographic maps obtained through the mapping agencies of national governments. The BSRN archive records this information in a floating point format with three decimal places. This is equivalent to an accuracy of approximately 3.5 seconds of arc, or about 108 metres in latitude and 76 metres in longitude at 45°. To obtain such accuracies, a map with a scale of better than 1:100000 is required. The latitude and longitude should be recorded in decimal degrees, North and East positive with both the South Pole and 180° W defined as zero. For example, a station located in the Northern Hemisphere and east of Greenwich, such as Potsdam, Germany (52 N, 13 E) would be encoded 142.000, 193.000, while for a similar latitude, but in the Canadian prairies (52 N, 105 W) the location would be encoded 142.000, 75.000. This is for consistency with the Archive station-to-archive file format.

Elevation can also be read from topographic maps, normally to within 5 metres. More accurate measurements require site surveys. The Archive records the elevation to within 1 metre.

In locations where a site is presently located, this information should be present with the required accuracy.

Global Positioning System (GPS) technology can provide the site location to within 30 m without correction and to better than 5 m with corrected systems. Elevation can also be accurately determined from GPS. For a new site, this technology may be the easiest and most accurate means of determining its location.

#### 3.1.4 General site description for the Archive

A second aspect of describing the site location is a general description of the surrounding area. The Technical Plan for BSRN Data Management (TPBDM), Version 2.1, defines two fields for the description of each site. The first field is *surface type*, while the second field is *topography type*. These fields are further described in Tables 4.14 and 4.11, respectively, of the TPBDM and are included as elements in logical record four of the station-to-archive file format. The tables are reproduced below as Table 3.1 and Table 3.2 for convenience. The format for each descriptor is I2.

While these tables are useful, they remain limited in describing the site fully because few sites fall easily into any simple set of categories as described. To aid researchers in understanding the overall complexity of the area surrounding a station, a more complete description, including topographic maps and photos of the site and its surroundings, is required.

### 3.2. BSRN Station Information Document

While the Archive information provides a brief description of the site and the site survey provides information on obstructions to the incoming radiative fluxes, if any, a more thorough description is necessary for data users. Individuals involved in the determination of climate change over time or the validation of satellite algorithms require detailed information about the site surroundings to determine the quality of the data for their specific needs. For example, individuals studying climate change require not only a knowledge of the general topography, but also details of city growth, changes in land use, farming techniques if in an agricultural area or flight patterns and frequency if near an airport over the time period of the measurements. Similarly, those using the data to obtain vicarious calibrations of satellite-borne instruments require similar knowledge to determine how representative the site is with respect to its surroundings. To provide this information, a more complete site description is required. The document, as described, has been modelled after a similar one designed for the Commission Internationale de l'Éclairage (CIE) International Daylight Measurement Programme.

<b>Data in relation <i>topography type</i></b>		
<i>Value</i>	<i>Topographic Feature</i>	<i>Population Density</i>
1	flat	urban
2	flat	rural
3	hilly	urban
4	hilly	rural
5	mountain top	urban
6	mountain top	rural
7	mountain valley	urban
8	mountain valley	rural

Table 3.1. Topography types used in archive site identification.

The description consists of 11 sections broken down into three main areas: General Description, Site Description and Station Description; much of this information is required for the Archive, but it is set up as an information package for prospective data users. A description of the information required to complete the package follows. A blank document is included in Annex A.

### 3.2.1 General Description

- (1) Information on whom the scientific authority is for the site. Postal address, telephone, fax and E-mail if applicable.
- (2) The site's location: latitude (N positive 0 - 90), longitude (East/West of Greenwich), Elevation above MSL, Local Time from GMT, Station Topography and Station Surface Type from the archive, and the date of the first data submitted to the archive.
- (3) Topographic map showing the land within a 15 km radius. A topographic map with a scale of approximately 1:250000 provides the appropriate resolution. This gives users a sense of the homogeneity of the surrounding areas.

### 3.2.2 Site Description

- (4) Site Surroundings: a written description indicating population centres, population density. When the station is within a large city, the following information should be added to the description: whether the city is growing, stagnant or declining in population. Major sources of pollution. Large bodies of water or significant local topographic effects should be noted. If the site is located at an educational institution or on the top of a building.
- (5) Climate characteristics: the general climate type (e.g., maritime, polar, etc.), climatic normals (min/mean/max summer/winter temperatures, mean rainfall etc.), significant climatic events (e.g., monsoons, hurricanes, tornadoes)
- (6) A map of the local area around the station (approximately a 1 to 2 km radius). A recent topographic map or photomap with a scale of 1:50000 provides the necessary resolution.

### 3.2.3 Station Description

- (7) A list of all the radiation fluxes being measured routinely at the station and the types of instruments being used. The type of data acquisition system(s) being used, the sampling rates of the data acquisition system and the outputs that are being archived. Information on the tracking and shading systems that are being used in obtaining the measurements is also required.
- (8) A station map: a detailed map indicating the location of the individual sensors in relation with each other. This map is primarily for the radiation instrumentation locations and need not include the location of the meteorological station or upper air station. Such information would be on the station map if the distances were greater than approximately 20 m.
- (9) A horizon view of the global radiation sensor indicating the major obstructions. This would be a figure utilizing the data supplied to the Archive running from North through South to North in a clockwise direction.
- (10) Comments on the site. For example, comments would include the instrumentation and data acquisition systems that are used for the meteorological variables. If another individual is the responsible contact for the meteorological portion of the site, the name and address would be included in these comments. A brief description of the method and frequency of the calibration of the sensors would be included in this set of comments. If a particular set of research measurements were being made at the site, this should be noted and the name and address of the appropriate contact given. This section can be used by the site manager to advertise anything that makes the particular site special.

<b>Data in relation surface type</b>		
<i>Value</i>	<i>Major Surface Type</i>	<i>Descriptor</i>
1	glacier	accumulation area
2	glacier	ablation area
3	iceshelf	-
4	sea ice	-
5	water	river
6	water	ocean
7	water	ocean
8	desert	rock
9	desert	sand
10	desert	gravel
11	concrete	-
12	asphalt	-
13	cultivated	-
14	tundra	-
15	grass	-
16	shrub	-
17	forest	evergreen
18	forest	deciduous
19	forest	mixed
20	rock	-
21	sand	-

Table 3.2. Surface types used in archive site identification.

- (11) Photographs of the station and its surrounds. Up to 4 photographs with appropriate comments should be provided. These can convey useful information concerning the instrument set-up and the surrounding horizon if there are significant obstructions. For example, if a tower is found on the site, a photograph may be appropriate to show where the instruments are located, or four pictures of the cardinal points of the compass from the central instrument with a wide-angle camera. In a manner similar to the comments section above, the photographs are to convey information about the station to the data users.

The BSRN Station Description document should be updated regularly. If significant changes occur in the instrumentation, the horizon or the ancillary measurements, corrections should be made immediately. In a manner similar to the horizon survey, the site description should be updated every five years.

### **3.3 Instrument Exposure**

To obtain data on the radiative field with respect to the surroundings, it is necessary to map the horizon of the instrument. With few exceptions this actual horizon will be different from the theoretical horizon because of buildings, trees or landforms. In some cases other instruments will create reflecting surfaces from which additional radiation will be incident on the receiver of the sensor of interest.

The archive requires that the elevation be catalogued at 10° intervals beginning at 0° N and ending at 350°. All prominent features are also to be catalogued and inserted as ordered pairs in the increasing sequence of azimuth angles. This accuracy is increased to a 5° interval for the published station description (see below).

The two most common means of accomplishing horizon mapping are by a survey camera, which exposes azimuth and elevation grid lines on the negative, or by theodolite. The advantage of the former is that it also provides evidence of various reflecting surfaces. In cases where a theodolite is used, either panoramic photographs or an all-sky image from the location of the instrument should also be obtained.

Surveys should be carried out before installation of the equipment and then at a minimum once every five years. If significant changes in the horizon occur, they should be documented immediately and a new site survey performed.

If buildings or other objects are in the near field of view, separate surveys should be made from the location of each instrument if they are affected differently.

In cases where the obstructions are highly reflective, a separate measurement of the reflected radiation should be attempted. This is of particular importance if the object is man-made and constant (e.g., a white building). This information should be submitted to the Archive as part of the metadata.

Corrections to the data to eliminate the effect of obstructions (e.g., assuming an isotropic radiance distribution and adding the difference between the actual and the theoretical horizon to the signal) should not be used. In cases where an object blocks the direct beam radiation during all or part of the year, the data during these periods should be appropriately flagged.

### **3.4. Additional Station Requirements**

The installation of the radiation instruments at a given location is dependent on a number of factors beyond the sighting of the instruments (Sec.3.1.1). This section is meant to provide a guide to ensure that these other factors are considered.

#### **3.4.1 Ease of Access**

Sensors must be easily accessible for daily maintenance. If the sensors are distant from the workplace of the support personnel, the quality of maintenance will be reduced, particularly following significant weather events. If the pyranometers are located on a building roof, access to the roof must be such that a technician will not be hesitant in inspecting or working on the instruments several times per day if required. If the instruments are mounted above the surface on a pole, a permanent platform or a ladder may be required so that the technician will be able to visually inspect the top of the instrument without difficulty. Safety factors must also be considered if instruments are to be located on towers or on the top of buildings. Human nature is such that instruments that are in areas that are inaccessible or can only be checked at some personal risk will be poorly maintained.

#### **3.4.2 Electrical Power**

The instrumentation used for the accurate measurement and storage of radiation fluxes and related meteorological variables requires reliable and stable electrical power over long periods of time. Depending upon the location of the site, to obtain and/or maintain such requirements may require devices as simple as surge protectors or as sophisticated as back-up generators. During the initial design phase of a BSRN station it is crucial to determine the quality of the electrical

power available. This can be accomplished by obtaining information on the power supply from the local power authority.

The minimum suggested protection on all crucial equipment (e.g., computers, trackers, line powered data acquisition systems) is an uninterruptible power supply (UPS) capable of maintaining the system during outages caused by electrical storms, increased commercial demand (brownouts) and automatic switching of grid loads due to equipment failures. Most of these outages only require that the system maintain the equipment for less than 10 - 15 minutes; often the interruption is for less than one or two seconds. Nevertheless surges or failures, even of this short duration, will cause the resetting and/or failure of equipment with an inherent loss of data.

Within the observatory, the complete power requirements, including design for future expansion, must also be considered. Transformers, fusing and wiring must be capable of bearing the load required to maintain the instrumentation. This problem is of particular concern when (1) individual circuits are overloaded with computing and data acquisition equipment or (2) long line lengths are required to conduct electrical power to distant field sites from a main panel.

### 3.4.3 Communication

At stations remote from network infrastructures, consideration must be given to transferring information from the observation platform to the laboratory where data analyses are performed. While formerly such data transfer took place by mailing information to the central processing facility, first on paper and later on diskettes, today a plethora of options is available. The intent of this section is to make the user aware of some of the possibilities available to transfer the collected measurements to the platform(s) on which the analyses occur. Expertise on the installation and operation of many of these methods should be available either from within national meteorological services or through private-sector consultants.

For data transport within a complex between two computers, a simple method is through direct serial or parallel communication. Many software operating systems now include built-in methods to allow easy communications between two computers without the complexity of local area networking.

Long-distance file transfer can be accomplished using normal telephone lines and high-speed modems for direct communication between computers. The frequency of the data transfer and the amount of data being transferred using this method will dictate both the temporal efficiency and overall cost of this data transfer method. Most high-speed digital serial modems are capable of transmitting data at about 40 kbs (kilobits per second). At this rate one Mb (megabyte) of data could be transferred in just less than 3.5 minutes.

The rapid advancement of the internet and world-wide web have made transfer of data over long distances much less expensive than using direct-dial telephone communications. Local internet service providers, which can be accessed through telephone, digital modem or through local area network connections provide a reliable and inexpensive means of delivering data over great distances. The more normal means of connecting to the internet are now being supplemented with direct line-of-site wireless and cellular telephone connectivity. Depending on the amount of data to be transferred several different options can be selected, varying from real-time constant connections to daily or less frequent data downloads.

When more than two computers are required to communicate, a simple Local Area Network (LAN) can be easily established. Using standard protocols (often sold as part of the computer operating system) and inexpensive adapters, several to hundreds of computers can communicate together, sharing resources, at far greater data transfer rates than serial communications. For example, data can be downloaded from a data acquisition system (e.g., Campbell Scientific CR7) using serial protocols (either locally or through remote communication methods) onto a single computer which is part of a network. This computer can then be accessed by many authorized users through a LAN. Data can be downloaded from the computer communicating with the data acquisition system through the network, or users can simply access the data from storage that resides at the site of the observations.

The Wide Area Network is similar in nature to a LAN but is designed to connect geographically distant locations. Within many countries national or regional governments operate WAN's for internal use (e.g., transfer of meteorological data from observing stations to the central forecast office). If these can be accessed to transfer data over long distances, significant operating cost may be saved, albeit at the expense of slower data transfer rates.

More sophisticated means of transferring data from remote locations are through radio frequency, cellular telephone and satellite transmissions. An example of the latter method is the United States NASA aerosol optical property network AERONET. In this case, a global network of instruments obtains measurements of aerosol optical properties that are transmitted once per hour via satellite to the Goddard Space Flight Center (GSFC) for analyses. This method, however, is limited by the amount of data that can be transmitted through existing meteorological satellites.

Whatever the means of communication selected, Stamper (1989)<sup>10</sup> provides an excellent set of criteria on which to base the decision. Each criterion should be considered, even though it may not be significant in the final selection process.

**Cost:** this includes the price of the medium selected, the installation of the necessary equipment (e.g., cable), software and hardware requirements (e.g., drivers and computer cards) specific to the medium and the ancillary cost of expansion, if and when needed.

**Speed (capacity):** this is broken into response time (the time required for each individual transaction) and aggregate data rate (the amount of information transmitted per unit time). An example of such is modem communication with a data logger every hour to download mean values of climate variables. The response time is the time it takes the modems to connect, while the aggregate time is the time it takes to download the data. In this case, the more complex the modems the greater the response time in determining speed and compression type, while the aggregate data rate may be of little importance because the amount of data is only several thousand bytes. Conversely, when transferring Mb of data, the aggregate data rate becomes the most important factor.

**Availability:** Is the medium available when there is a need to utilize it? For example, if using common carrier telephone lines, does one get a 'busy' signal at the times data is to be transferred, or is the telephone system so busy that lines are unavailable (e.g., during special holidays).

**Expandability:** Can the system be enlarged for increased demand? This can be an increase either in the number of stations using the communication system or in the amount of data being transmitted through the system. An example of the latter would be the upgrading of telephone modems to higher baud rates to handle increased amounts of data transfer over the same time period (increased aggregate data rate).

**Errors:** All means of data transmission are subject to signal distortion, which can produce errors in the data. To reduce this problem, data communication environments transmit redundant data to detect if such errors have occurred. The more complex the method used for detecting such errors, the slower the data throughput, but the higher the probability that the data will be error free. The number of copies of the data and how long each copy is maintained should in part be correlated to the frequency of data transmission errors. In turn this will dictate part of the overall cost of the system.

**Security:** The ease of access by outsiders increases the threat of breaches in security. This can vary from someone accidentally interrupting a data transfer to vandals physically or electronically destroying equipment and

---

<sup>10</sup> Stamper, D.A., 1989: *Business Data Communications*, 2<sup>nd</sup> Edition, Benjamin/Cummings Publishing Co. Ltd., Redwood, CA, U.S.A.

data. While it is impossible to have complete defence against loss, the need for security must be balanced against the cost of its implementation.

- Distance:** The physical distance between the data collection location and the data archive location will often determine the methods of communication that are available. For example, the only viable solutions for long distances may be common carriers or even satellite communications, while shorter distances (e.g., within a complex of buildings) can utilize hardwired local area networks.
- Environment:** Physical or legal constraints may affect the type of medium that can be used. Local ordinances may prohibit the use of certain types of radio communications or the laying or stringing of cable. Climatic variables, such as wind, temperature, rain and icing conditions also need to be considered when selecting a communication medium. For example, overhead wires in areas where icing is a common problem may not provide a reliable means of communication.
- Application:** Peculiarities in particular applications will dictate significant portions of the selection of a media. This is especially true at remote sites where power conservation requires only limited communication access. The slowest portion of the communication chain will also dictate the overall requirements of the entire chain. For example, if communication between a data logger and a computer, through common carrier lines, is constrained by the baud rate at which the data logger can transfer the data to the modem, there is no reason to purchase modems with a higher baud rate.
- Maintenance:** All media are subject to failure. The system design should take into account the probability of a failure, the cost of such a failure to the user in money and inconvenience, and the ability of the user to obtain alternate communication media for the duration of the failure. Routine maintenance must also be considered in terms of down time and overall cost of the system.

#### 3.4.4 Security

Depending upon the location, security may be a significant consideration. Security is both for the protection of the site against vandalism and theft, and for the protection against harm of would-be intruders (the concept of being responsible for a thief's well-being while on the victim's property may well be found only in North America).

At a minimum the measurement site should be well-fenced against intruders, both human and animal. Further security measures may include alarm systems, security lights (on buildings, but away from the instrumentation) and video camera systems.

In some locales special security should be considered against burrowing and gnawing rodents.

### 3.5 Site Preparation

The preparation of the site before measurements begin consists of designing the installation to reduce interference of the sensors from buildings and other sensors, ensuring that the instrument platforms are appropriate for the climate and soil conditions, and designing a signal cable grid that is efficient and easy to maintain. While general principles can be applied to each of these aspects of the site, individual stations will require special adaptations to the following procedures.

#### 3.5.1 Instrument siting

Care must be taken so that the instruments do not interfere with each other. Ideally, instruments should be far enough apart that they become insignificant objects in the field of view of adjacent instruments. Space limitations, however, often restrict the distance apart instruments can be placed. To reduce such interference, the instruments should be lined up in a poleward direction with slightly increasing elevation. In cases where the measurement of diffuse radiation and direct

radiation are separate, the diffuse and infrared (if shaded) measurement should be the furthest poleward and slightly elevated, while the direct instrument should be closest to the equator and at the lowest height. The global instrument should be centred between these two instruments and higher than the direct instrument. The global, diffuse, and infrared instruments should be at the same height, with only the shade portion of the diffuse apparatus extending above the height of the thermopile of the global instrument. In the case where the direct and diffuse instruments are set on the same tracking platform, the direct beam instrument(s) should not interfere with the horizon of the diffuse instruments.

When locating instruments that measure upwelling fluxes it is important to be able to service these instruments from their poleward direction to reduce ground disturbance that may affect direct reflectance into the sensor from the sun. For example, significant differences in snow albedos can be observed because of the effects associated with the depressions caused by footsteps near a downfacing instrument on its solar side.

For meteorological instrumentation, distant horizon problems are minimal but interference between instruments is significant. For the measurements of temperature and pressure, the

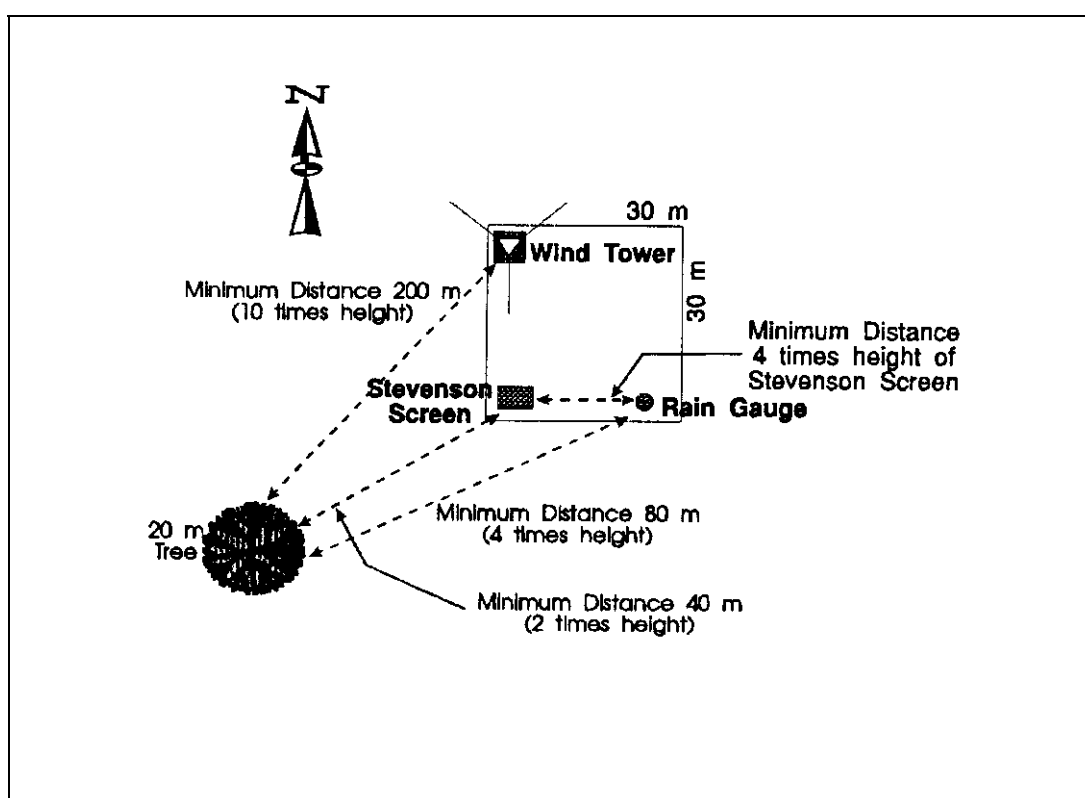

Figure 3.1. Diagram indicating appropriate distances from an obstruction meteorological instrumentation (from AES Guidelines for Co-operative Climatological Autostations, Version 2.0).

Stevenson screen (or equivalent) should be at least twice the distance apart from the height of all significant objects. These objects should be located poleward of the measurement site so that shading will not interfere with the instruments within the screen. Instruments used to measure precipitation should be located no closer to the nearest obstruction than four times the height of the obstruction. An instrument for the measurement of wind must be at least 10 times the height of an object distant from that object. For example, the 10-metre mast in Figure 3.1<sup>11</sup> is located 200 m away from the 20-metre tall tree. If the instrumentation cannot be located the prescribed distance from the obstruction, then the instrument should be located in a location where the obstruction

<sup>11</sup> AES Guidelines for Co-operative Climatological Autostations, Version 2.0, Climate Information Branch, Canadian Climate Service, Atmospheric Environment Service, Downsview, Canada, M3H 5T4, 1992. 85 pages.

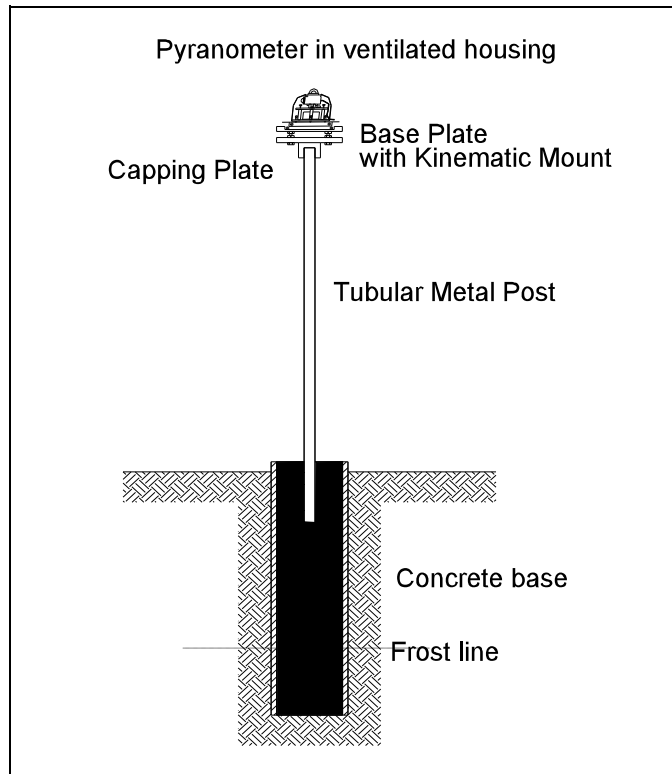

Figure 3.2. Simple post mount in concrete base.

least affects the data. In the case of a wind mast, the mast should be placed where the obstruction alters the wind field of non-prevailing winds. Distances from growing vegetation should be increased to account for any future growth.

### 3.5.2 Instrument platforms

Instrument stands can be as simple as a vertical post holding a single pyranometer or as complex as a raised platform that can hold a large number of individual instruments and trackers. In all cases, the platform must be stable over long periods of time, resisting warping by changes in temperature and humidity, and be immovable in strong wind conditions (to within  $\pm 0.05^\circ$ ). In most climates, wooden platforms should not be used because of their tendency to warp with humidity and seasonal changes and because of attack by insects. In temperate climates platforms made of steel or aluminum provide both the necessary stability and durability required for radiation measurements. In hot climates though, these may be inappropriate because of extreme heating (both with respect to expansion and ease of access due to heating). Reinforced concrete, or concrete and steel structures, when expansion is considered, are probably the optimal materials for the construction of stands, whether they are simple posts or complex platforms.

The base of any post or platform either must be firmly attached to a building or dug into the ground. In the latter case, the base of the structure should be anchored at a depth below any material that may be subject to heaving due to frost or water. A local or national building code, where available, will provide excellent information on both the depth to which posts must be implanted and the means in which this is best accomplished. If further information is required, a qualified mechanical or civil engineer familiar with the location should be consulted. Figure 3.2 illustrates a typical post installation for a continental site in well drained soil, while Figure 3.3 illustrates the more complex Canadian platform required to elevate the instruments above the local horizon.

Along with the structural integrity of the platform, the height of the platform above the surface must also be carefully considered. As previously mentioned, in built-up areas up-facing sensors can be located on the top of buildings to overcome local horizons. In more rural areas instruments can be located as close as 1.5 m above the surface. In the latter case, consideration must be given for terrain effects such as blowing or accumulating sand or snow. When instruments are placed higher than approximately 1.5 m, a means of accessing the instrument for cleaning must be

provided. This can vary from a permanent deck structure to a simple step ladder, remembering that the easier the access to the instrument the more likely the instrument will be well maintained.

If the instrument is to be mounted on the roof of a building care must be taken to guarantee that the instrument will not be blown off during high winds. The secure anchoring of the instrument stand should be done in consultation with the building manager or engineer. If possible, a permanent installation with the instrument stand bolted to the building is preferable to the use of stands set on the roof and secured only by heavy weights.

Depending on the site, further measures may be required to ensure the stability of the pyranometer platform during high wind conditions. Extra guy-wires or bracketing may be added to keep the stand from oscillating.

### 3.5.3 Cables

#### 3.5.3.1 Signal cables

Just as important as determining the best field of view for the instruments, is the routing of the signal cable from the instrument to the data acquisition system. As most surface-based radiometers are thermopile instruments, the maximum signal is usually in-the-order of 10 mV for a  $1000 \text{ W m}^{-2}$  flux or  $10 \mu\text{V W}^{-1} \text{ m}^2$ . Such small signals can be affected easily by large line resistance, due to long cable lengths, and electrical interference from other sources, particularly AC power lines running parallel to the signal lines. Several suggestions follow to aid in the design of the measurement system.

- (1) All signal cables should be twisted wire configured as a ground and signal pair sheathed in a foil wrap. The outer sheathing of the signal cable should be based upon the climatic regime of the station and the overall EMF to which the cable is to be subjected. It is recommended that cables be made of stranded copper for flexibility.
- (2) Cable lengths should be kept as short as practically possible. The overall length of the cable is dependent upon the remoteness of the measurement platform and the type of data acquisition system being used to sample the signal. Types of data acquisition systems are discussed in Section 6.

Where long cables are required and the total resistance of the cable is greater than  $10 \Omega$  (approximately 50 m), a pre-amplifier should be placed at the instrument end of the system. Extreme care should be taken with this solution because of the temperature dependency and non-linearity of electronic components.



Figure 3.3. The support structure used to elevate instruments above the local horizon. The structural steel and concrete support structure at the Bratt's Lake Observatory, Meteorological Service of Canada.

A number of dataloggers are capable of withstanding harsh environments, including hot and cold temperatures and high relative humidity. Such data collecting platforms should be considered as an alternative to transmitting small analog signals through long cables back to a central facility. Once the data is collected it can be transferred much more reliably as a digital signal.

- (3) All cables that run along the ground should be buried to a depth where they will not normally be disturbed by routine maintenance operations. Cables not specifically capable of withstanding burial should be placed in conduits. This increases the overall neatness of the site and reduces the danger of personnel being injured or the cable being accidentally pulled from the instrument when overly strained. When effort is being expended to place cables underground, extra capacity for future expansion should be considered.
- (4) Signal cables should be run through separate conduits from electrical power cables whenever possible. Cables should cross at right angles to reduce electrical interference. When such arrangements are impractical, specially shielded cables should be used.
- (5) At remote locations, secondary signal processing and serial or satellite communications should be considered to transfer data to a permanent storage device. In the design of such a system, the potential for communication failures must be considered in the overall plan.

Cabling between the instrument and the data acquisition system should be carefully grounded and protected against lightning. Figure 3.4 gives a general illustration on how the grounding and lightning protection should be placed within the instrument/cable/acquisition system configuration.

Whenever a system is wired, care must be taken to accurately map both the physical location of the cables (especially if underground) and the connections running from the instruments through the junction boxes to the data acquisition system.

### 3.5.3.2 Electrical Cable

Electricity should be available at the location of the sensors, both for the operation of the instruments and for use in the maintenance of the observation platform. Separate circuits for each set of instruments is desirable, but not always practical. Whenever redundant instrumentation is used, it should be operated on separate electrical circuits. All electrical wiring should meet or exceed local electrical codes. The local electrical utility, an electrical engineer or qualified electrician should be able to provide information on local electrical regulations and provide an estimate of the electrical consumption of the site.

Just as in the case of the signal cables, all electrical cables should be buried or securely fastened to the instrument mounting platforms. Furthermore, for safety, switches or circuit breakers should be installed close to the equipment for easy servicing.

The quality of power supplied to the instruments should be the same as described in Section 3.4.2.

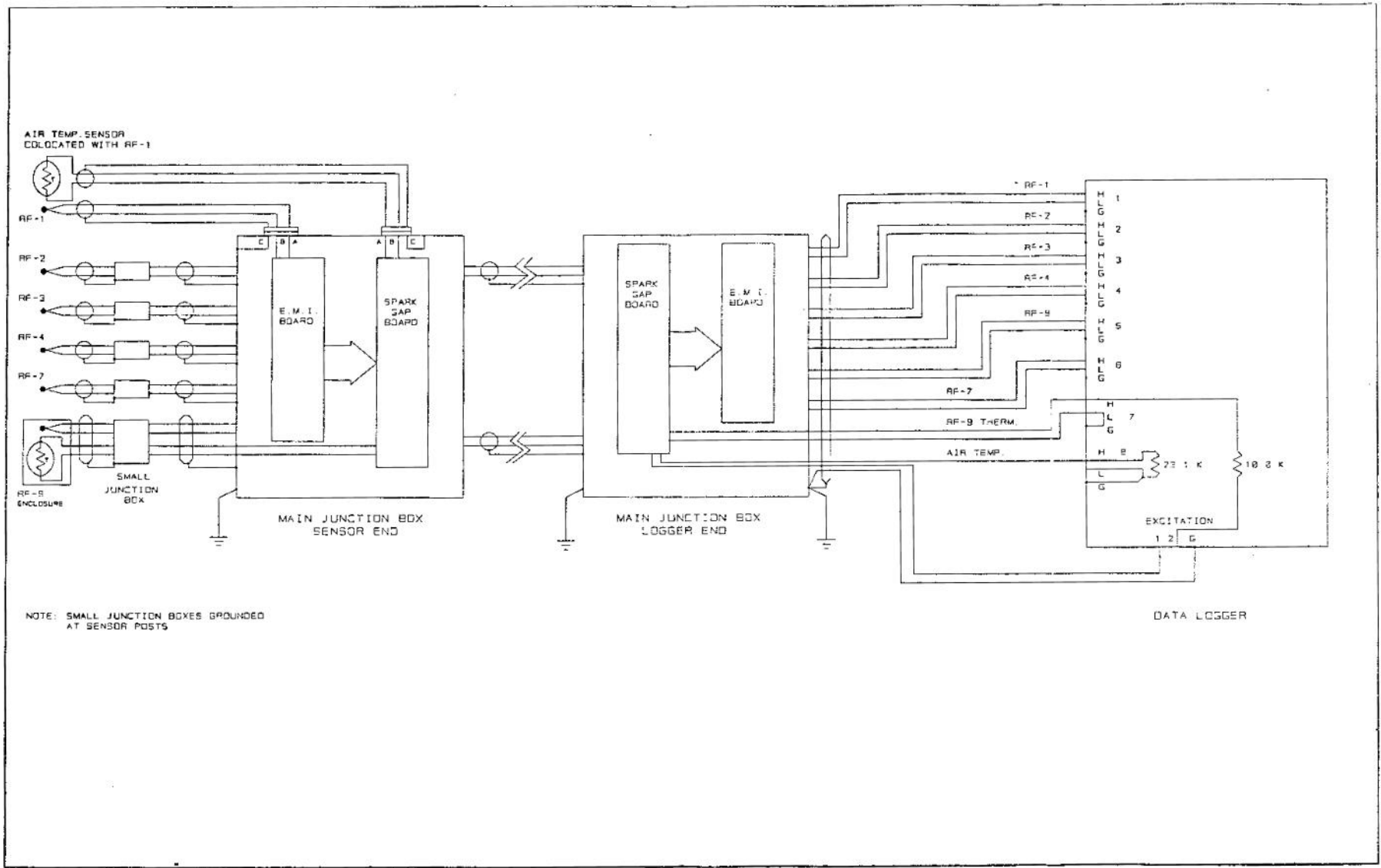

Figure 3.4 Generalized schematic of the interface between radiation sensors (RF) and a data acquisition unit showing lightning protection and cable grounding.

## 4.0 Installation of Radiation Instruments

### 4.1 General

The installation of pyranometers, pyrhemometers and pyrgeometers is relatively simple (Annex B provides information on some of the instruments that may be suitable for use at BSRN stations), but nevertheless requires care and attention to detail.

Originally, the BSRN recommended that the manufacturer and type of instrument used for the measurement of global radiation should also be used for the measurement of diffuse radiation. This was to reduce uncertainties associated with the temperature and angular responsivities of the instrumentation. In consideration of the uncertainty associated with the thermal offset associated with 'black' thermopile instruments, high quality B&W instruments, that have low thermal offsets, have identical, or a similar dome spectral characteristics (particularly in the shorter wavelength range), and have good directional responsivity may be substituted. A careful analysis should be performed to determine that the means of measuring both diffuse and global irradiance minimizes the overall uncertainty of the measurement.

It was also recommended originally that the pyrhemometer used be of the same manufacturer as the pyranometers, primarily to ensure that the spectral response of the two instruments be identical. Subsequently, it was discovered that the use of instrumentation constructed by the same manufacturer did not guarantee similar spectral responses because different materials were used for the pyranometer domes and for the optical flats of the pyrhemometers. Rayleigh scattering alters the spectral distribution of energy at the surface so that the proportion of near infrared (NIR) radiation in the diffuse irradiance signal is less than that measured in the direct beam and in the global radiation spectra. To capture this radiation signal, which can be significant in a dry atmosphere, the suggestion has been brought forward to use quartz, sapphire or calcium fluoride optical flats on pyrhemometers. The manufacture of domes using the latter two materials is uncommon, expensive and unnecessary for the measurement of diffuse irradiance. Therefore, the selection of the types of instruments to be used for the measurement of the various components must be based on a careful uncertainty analysis of the instrumentation and the atmosphere under which the measurements are to be made. Included in this analysis must be the recognition that the three measurements are to be used in the quality assurance of the data.

A number of documents, including manuals provided by manufacturers, have been published that include information on the installation of these instruments. Documents published by technical agencies include:

*Radiation Measurement*. International Field Year for the Great Lakes, Technical Manual Series No. 2, National Research Council of Canada, 1972.

*Revised Instruction Manual on Radiation Instruments and Measurements*. World Climate Research Programme, WCRP Publication Series No. 7, WMO/TD No. 149, 1986.

*Meteorological measurements concerning questions of air pollution, Global radiation, direct solar radiation and net total radiation*. VDI-Richtlinien, VDI 3786, Part 5, 1986.

*Solar Energy - Field Pyranometers - Recommended practice for use*. International Standards Organization Technical Report TR9901, 1990.

### 4.2 Installation of pyranometers and pyrgeometers

#### 4.2.1 Pre-installation Checks and Service

Before installing any pyranometer the instrument should be carefully inspected.

- (1) If not provided by the manufacturer, the instrument should be calibrated so that the following information is available:
  - (i) the responsivity of the instrument to radiation
  - (ii) the spectral range of the instrument
  - (iii) the linearity of the instrument between 0 and  $1500 \text{ Wm}^{-2}$

- (iv) the directional responsivity of the instrument (cosine and azimuthal response of the instrument) for pyranometers
  - (v) the deviation of the temperature compensation circuit of the instrument over the temperature range (-10° to +40° of range) or if not compensated, the required temperature correction of the instrument. In climates where the temperature range is greater than that specified, instrumentation should be selected to meet the temperature regime. For the most accurate measurements, the temperature of the thermopile should be monitored and the signal corrected for temperature variations. A number of instruments using non-thermopile sensors may be considered if they meet all other criteria.
  - (vi) the instrument has been radiometrically levelled. That is, the thermopile is horizontal when the bubble level indicates such (the bubble level should have an accuracy of  $\pm 0.1^\circ$ ).
- (2) Checks should be made of all wiring to ensure that there are no nicks in the sheathing nor stress on the connections. The wire should be of a variety that will withstand the climatic regime of the area in which the instrument is to be installed.
  - (3) All O-rings should be lubricated lightly with a very fine grease (e.g. Dow Corning Model 55 O-ring lubricant or Fischer Scientific Cello-Seal C-601).
  - (4) All threaded parts should be lubricated in a manner similar to the O-rings.
  - (5) The thermopile (or the signal transducer) should be visually inspected to ensure that the surface is uniform in colour and texture.
  - (6) The BSRN accuracy guide indicates that the case temperature of the instrument should be monitored. If the instrument is fitted with a thermal measuring device, the wiring should be checked and the reduction algorithm tested at known temperatures. In the case of pyrgeometers, all thermistors should be tested.
  - (7) The inner and outer domes should be checked for scratches or nicks. If found, the domes should be replaced. In the case of pyrgeometers a similar check should be made of the silicon dome. However, if the dome requires replacement due to damage, the instrument must be re-calibrated.
  - (8) The impedance of the instrument should be checked against the manufacturer's values.
  - (9) The desiccant should be fully activated. It is recommended that the desiccating material be of the bead type (e.g. Trockenperlen, Kali-chemie AG) and not one which easily powders (e.g. Drierite, Hammond Drierite)
  - (10) All connectors must be waterproof and should be appropriate for the climatic conditions in which the sensor will be deployed. For example, in marine environments care must be taken against using connectors that are prone to corrode. It is recommended that keyed connectors be used for greater safety in maintaining instrument polarity.

#### 4.2.2 Mechanical Installation

- (1) The instrument should be mounted with the direction of the connector facing poleward for fixed platforms and away from the solar disk when mounted on solar tracking devices.
- (2) The instrument must be fastened to the platform (or ventilating device (see below)) so that it will not move in inclement weather. The bolts used should be lubricated before assembly for ease of disassembly. Initially, these bolts (normally two or three depending upon the instrument) should be not be tightened until the instrument is levelled according to its bubble level.

Spring loaded bolting devices for mounting the instrument are also an excellent means of guaranteeing the instrument will remain fixed while providing the added ability of levelling the instrument without requiring the bolts being loosened.

- (3) The instrument should be levelled using the supplied three levelling feet. By first adjusting the foot closest to the bubble, the instrument should be adjusted until the bubble is centred within the inner circle of the supplied bubble. When completely centred, and radiometrically levelled, the bubble level indicates that the thermopile is horizontal to within  $\pm 0.1^\circ$  causing an azimuthal variation of  $\pm 1\%$  at a solar elevation of  $10^\circ$ .
- (4) Carefully tighten the retaining screws so that the instrument is immovable. To do so, gently tighten the bolts alternately until secure. Be careful not to over-tighten.
- (5) Place and adjust the radiation shield or ventilated housing cover so that it is parallel to, and level with or below the thermopile surface.

#### 4.2.2.1 Ventilated housing

The recommended procedures for the measurement of global radiation require the use of a ventilated housing to improve the overall stability of pyranometer measurement by damping changes in the pyranometer body temperature due to solar loading and potentially reducing the thermal offset. In some climates, the use of a ventilator also improves the amount of recoverable data by eliminating dew and reducing the number of occurrences of frost and snow on the instrument domes. Measurements in other regions, however, have not shown a significant increase in accuracy or percent data recovered with the use of ventilated housings. As each ventilator adds extra cost and complexity to the installation and maintenance of a station a thorough analysis of its requirement should be made before installation.



Figure 4.1. Ventilator with motor located beside the instrument as used by Deutscher Wetterdienst.

Locations where a ventilated housing are recommended are:

- (1) where dew, frost or snow is prevalent,
- (2) where natural ventilation is infrequent or variable,
- (3) where there is significant radiative cooling during portions of the year, a ventilated housing may reduce thermal-offset,
- (4) where the humidity is high during portions of the year a ventilator will reduce the possibility of water damage and reduce the frequency of desiccant changes.



Figure 4.2. Ventilator with the motor located beneath the instrument. Note the extra ventilation holes near the top of the housing used to reduce snow accumulation (Davos, Switzerland).

The two recommended styles of ventilated housing are:

- (1) Where the ventilator fan is situated beside the instrument and the pyranometer is completely enclosed so that the air flows evenly around the dome. Figure 4.1 illustrates this type of blower as used by the Deutscher Wetterdienst. The advantage of this design is the ease in which a fan can be replaced without tampering with the pyranometer. Conversely, the design is more complex because the air is entering from one side of the pyranometer and must be funnelled around the instrument to pass over the dome equally from all directions. This may require the use of a larger fan than those ventilators that pass air around the instrument from beneath. The temperature of the instrument in the encapsulated ventilator and, to a lesser extent the instrument dome, will rise slightly above the ambient temperature due to the heating of the air by the blower motor.
- (2) Where the housing encloses the pyranometer and the ventilator fan is located beneath the instrument and blows air from beneath the housing, around the instrument and over the dome (Figure 4.2). This is the more common of the two recommended ventilation systems. The power dissipation heats the incoming air by approximately 1°C, which in turn heats the body and dome of the enclosed instrument. Unlike (1), the instrument must be removed from the housing before a fan can be replaced. The area beneath the instrument must also be kept free from obstructions to maintain airflow.

The heating effect on the dome due to the fan motors is negated when wind speeds are moderate to high.

Heating resistors can be added to both ventilators if required during cold weather operations. Care must be taken, however, in that these may also alter the overall response of the instrument.



Figure 4.3. An one-axis tracker used in shading a pyranometer. Note the use of two fine wires to maintain the stability of the shading disk. (Developed by Deutscher Wetterdienst).

#### 4.2.3 Mechanical installation of shaded sensors (pyranometers and pyrgeometers)

The general installation of shaded sensors follows the guidelines set out in 4.2.2, but includes the added complexity of aligning the shading device with the instrument. Within the BSRN, shade rings (diffusographs) are not accepted as a means of shading an instrument because of the field of view the ring subtends. Two types of devices are commonly employed within the BSRN.

Figures 4.3 and 4.4 illustrate synchronous motor shade devices as designed by the Germans and the Swiss. The German device uses a single axis to carry the pyranometer about which the shade-disk rotates. This design is significantly more complex than the Swiss design, but is more efficient in using space. The Swiss design fixes the pyranometer on a stable, level stand mounted separately from the equatorial motor. The position of the shade disk must be moved along the shading arm with the changing solar declination. The size of the arm holding the disk may reduce the amount of diffuse irradiance detected by the sensor. To reduce this effect, the German design has reduced the overall dimensions of the shade-arm by adding guy-wires to the design. Consideration must be given to the location of the instrumentation when determining how robust the design and dimensions of the shade-arm need be. Locations that experience high winds, driving precipitation or significant snowfalls will require a more robust design than less hostile environments.

While inexpensive to fabricate, these devices require more daily maintenance than shade systems that operate on two-axes trackers. Problems associated with synchronous motor shade arms are similar to those of solar trackers used for the measurement of direct beam irradiance (Section 4.4).

The general installation of devices similar to those of the German and Swiss that use a single-axis synchronous motor system for shading are equatorial mount are similar.

- (1) The pyranometer be maintained in a stable, horizontal position.



Figure 4.4. View of two Swiss oversized tracking disks. Note how the pyranometer is physically separated from the motor and the shade device. The increased width of the arm holding the shade disk eliminates the need for stabilizing wires, but increases the amount of sky obscured. The slot along the arm is for the movement of the shade disk. On the instrument to the right of the photograph, the vertical wires are used to deter birds perching on the instrument. (Courtesy of MeteoSwiss, Payerne, Switzerland.)

- (2) The synchronous motor must:
  - (I) be wired appropriately to the electrical power frequency of the location of installation,
  - (ii) be wired to follow the path of the sun (opposite for northern and southern hemispheres),
  - (iii) be mounted on a level baseplate,
  - (iv) be perpendicular to the horizon,
  - (v) be located equatorward of the pyranometer,
  - (vi) be aligned true north-south,
  - (vii) be pointing poleward at an angle equal to the latitude of the site,
  - (viii) be in a position such that a line extending from the motor axis pass through the centre point of the instrument sensor.
  
- (3) The cables of the pyranometer (and ventilator) must be routed in a manner that will not interfere with the shade arm. In the Swiss case, this is done by having the shade arm able to rotate about the stand on which the pyranometer is located, while in the German case the wires are passed through the centre of the axis.
  
- (4) The area around the instrument must be free of obstructions so that the arm can rotate a full 360°. This includes the surface on which the instrumentation is mounted.

Two-axis trackers can be used either as a means of shading one or more instruments or as a combination unit where a pyr heliometer is also attached to the tracker. Figure 4.5 illustrates the Australian computer-controlled active-tracker on which the normal incident direct beam is measured using a pyr heliometer coincidentally with a pyranometer being shaded with a shade-disk, while Figure 4.6 shows a Canadian

designed system shading both a pyranometer and pyrgeometer along with measuring the normal incident direct beam (see Section 4.4 for details on two-axes trackers). To use the tracker as a platform for both the shading of a pyranometer and the pointing of a pyrliometer, the elevation drive must be mechanically translated so that it is horizontal and at the same height as the signal transducer of the instrument to be shaded. In both cases, the shade disk(s) (or the shade sphere(s)) remain at a fixed distance from the instrument sensor via the cantilevering-motion provided by the armature. Once installed, care must be taken not to rotate the elevation drive of the tracker below the position where the cantilever system binds on itself. This is accomplished by not allowing the elevation axis to go more than about 5 - 10° below the horizon before programming the tracker to "go to sleep" and/or return to a pre-sunrise position. Depending upon the type of tracker (especially if it is a friction drive), the number of steps taken to move 360° must be checked. This maintenance procedure requires that the shade assembly be disconnected from the tracker.

Whether using a single-axis or two-axes tracker, the instrument requiring shading must be placed precisely so that the shade of the diffusing disk completely covers the outer dome of the instrument. The general rule presented by the WMO for pyrliometry is that the ratio between the length and the diameter of the opening angle of a pyrliometer is 10:1. This rule can be used to approximate the geometry of the disk or sphere used to block the irradiance from solar disk. Major (1992)<sup>12</sup> discusses the use of pyrliometers and shaded pyranometers for calculating global radiation with respect to the optimum design of the shade disk. The results indicate that the best equivalence can be expected if the distance between the receiver and the shading disk is chosen so that the slope angle is larger and the opening angle is less than those of the pyrliometer in use. Major (*Personal Communication*) has calculated that diffuse/direct irradiance measurements made at various BSRN stations using standard systems may increase discrepancies between the global irradiance measured by a pyranometer and the summation of the diffuse and direct irradiances by up to 5 W m<sup>-2</sup>. Optimized arm lengths and shade diameters improve this to better than 0.5 W m<sup>-2</sup>. Table 4.1 provides optimal geometry for several common combinations of pyranometers and pyrliometer or cavity radiometer. Further work on this issue has been done by the BSRN Working Group on Diffuse Geometry, culminating in a final report that is reproduced as Annex C. While the advantages of using a two-axes tracking system for measuring both diffuse and direct beam irradiance are numerous, there are several disadvantages that should be considered:

- (1) The use of a computer-controlled system increases the risk of failure over a synchronous motor tracker because more complex equipment is involved that can fail (e.g. computer components, tracker electronics).
- (2) By using a single system to measure multiple components, a single failure can affect several types of observations. This will remove the redundancy established in measuring global, diffuse and direct beam irradiance.
- (3) If the tracker is not properly tracking the solar disk, errors in the direct beam and diffuse irradiances may be nearly offsetting so that normal quality assurance procedures may not be adequate. The use of an active sensor (either directly connected to the tracking system or simply monitoring the solar position) will provide the extra information necessary to determine whether or not the tracker is following the sun. Errors in tracking are due to incorrect date and time, or in the case of friction trackers slippage of the friction disk. This latter problem is normally associated with human activity.

---

<sup>12</sup> Major, G., 1992: Estimation of the error caused by the circumsolar radiation when measuring global radiation as a sum of direct and diffuse radiation. *Solar Energy*, 48(4), 249-252.



Figure 4.5. Australian active tracker used for both diffuse and direct beam measurements. This tracker is shading a single pyranometer, and pointing two normal incidence pyrheliometers and a GAW PFR sunphotometer on one side of the tracker and another pyrheliometer on the far side of the tracker. An active-eye is also situated on the far side of the tracker. (Courtesy Bureau of Meteorology, Australia)

<b>Pyranometer</b>	<b>Radius of shading disk/sphere</b>	<b>Arm length required for Eppley HF</b>	<b>Arm length required for Eppley NIP</b>	<b>Arm length required for Kipp and Zonen CH1</b>
Eppley PSP	25.4	635	605	510
Eppley 8-48	30	726	703	574
Kipp and Zonen CM11 or CM21	25.4	630	603	505
Schenk Star	34	840	815	668

Table 4.1. Optimized shade geometry for common instruments. The optimization considers solar aureole conditions, solar elevation and instrument characteristics (courtesy of G. Major and M. Putsay)



Figure 4.6. Canadian computer-controlled, friction-drive tracker used for measuring direct beam, diffuse and infrared radiation using a shaded pyrheliometer. The pyrheliometer mounting block is capable of holding three instruments, including an active cavity radiometer. A second mounting place is mounted on the opposite side of the tracker.

#### 4.2.4 Installation of downfacing sensors (pyranometers and pyrgeometers)

Downfacing sensors should only be installed when the sensor can be located a minimum of 30 m above the surface to increase the representativeness of the field of view. The tower from which the instrument is to be deployed should be as compact as possible while recognizing the need for individuals to climb the tower to service the instrument. Open towers provide less interference of the radiation flux than solid towers of the same dimension. The further the instruments are mounted away from the tower on booms, the less the tower influences the radiation field. In the worse case scenario of a solid tower of diameter  $D$  with a boom of length  $L$  measured from the centre of the tower, the fraction of radiation intercepted is  $D/2\pi L$ .

In all cases the sensors should be installed with the tower poleward of the instruments. This will eliminate self-shading except in high latitude locations where the solar disk does not drop below the horizon during the hemisphere summer and in equatorial locations that are affected by the passage of the sun between the Tropics.

As in the case of the up-facing sensors, the sensors must be horizontal. To accomplish this, however, is more difficult because the bubble levels attached to the instruments no longer function properly.

Two methods are suggested to help overcome the levelling problem:

- (1) By assuming that the rotation of the instrument about its horizontal axes is true, the instrument can be levelled in the up-facing position with its own bubble level and then rotated  $180^\circ$ .

This method works well if the instrument is on a vertical post attached to the boom extending from the tower. The pyranometer is levelled while the post is vertical in an upright position. The measurement of the angle of the post can be accomplished to within 0.1° using a high quality carpenter's level.

- (2) The second procedure requires the construction of a levelling jig. This consists of a flat planed parallel piece of metal attached to a circular ring whose diameter is such that it will sit around the outside dome of the pyranometers to be inverted. The ring must have known parallel ends. The metal flat (which can be reversed, side-to-side) is attached to one end of the ring, while the other end of the ring sits on the ring surrounding the pyranometer outer dome. To improve the performance of this tool, three small 'feet' may extrude from the instrument end of the ring for positive placement on the pyranometer. On the far end of the metal plate an adjustable circular spirit level is attached for the ultimate levelling of the pyranometer (pyrgeometer) to be used in the downfacing position.

The pyranometer is first levelled in its normal position following radiometric levelling of the instrument. The levelling tool is placed on the pyranometer and the adjustable level on the plate set to conform to the instrument bubble level. The plate is then turned over so that the bubble level will be upright when the pyranometer is inverted.

When attaching the pyranometer to its inverted position, spring loaded retaining bolts are required to maintain a constant pressure against which the levelling feet can be adjusted. The level can be set by holding the levelling jig against the instrument and adjusting the levelling feet of the pyranometer in the normal manner.

### **4.3 Installation of instruments for the measurement of direct beam radiation**

#### **4.3.1 General Considerations**

The original goal of the BSRN was to use a cavity radiometer with an open entrance aperture for the measurement of direct beam radiation. This was later amended to include the use of a normal incidence pyrliometer (or more simply pyrliometer) to fill gaps in the data stream during those time periods when the cavity radiometer was in calibration mode. Further amendments were made to the original concept when concerns about protecting the open cavity radiometer against the elements were brought forward. Further investigations have found that calcium fluoride or sapphire optical flats provide good protection from the elements while transmitting virtually the full solar spectrum. The ideal configuration for the measurement of direct beam radiation remains the use of either an open all-weather cavity radiometer or all-weather cavity radiometer with the appropriate optical flat used for protection along with a pyrliometer preferably capable of measuring the same spectral range, that can be used to complete the data set during the periods the cavity radiometer is in calibration mode. Thus the cavity radiometer is the primary instrument with the pyrliometer being used to fill the 'calibration gaps' by correlation with the observations obtained during the cavity measurements periods preceding and following the calibration time period. The actual frequency and length of time required for the self-calibration period depends upon the type of the cavity radiometer. Lesser alternatives, however, are acceptable. In rank order of preference these are: (1) The use of a pyrliometer as the primary instrument while an open cavity radiometer is used in tandem at all times weather conditions permit. In this manner, the pyrliometer is calibrated against the cavity radiometer nearly continuously. (2) same as (1), but with a cavity radiometer with a quartz flat covering the entrance aperture. This cavity in turn is to be calibrated against an open aperture cavity radiometer to account for the effect of the flat. (3) The use of two pyrliometers measuring on a routine base, with an open aperture cavity radiometer checking the calibration on a periodic basis during high solar radiation conditions.

#### **4.3.2 Pre-installation checks and service**

- (1) If not provided by the manufacturer, the instrument should be calibrated so that the following information is available:
  - (i) the responsivity of the instrument to radiation
  - (ii) the linearity of the instrument between 0 and 1500 Wm<sup>-2</sup>

- (iii) the deviation of the temperature compensation circuit of the instrument over the temperature range (-10° to +10° of the local range in temperature) or if not compensated the required temperature correction of the instrument
  - (iv) the opening angle and the slope angle of the instrument
- (2) Checks should be made of all wiring to ensure that there are no nicks in the sheathing nor stress on the connections. The wire should be of a variety that will withstand the climatic regime of the area in which the instrument is to be installed.
  - (3) The BSRN accuracy guide indicates that the case temperature of the instrument should be monitored. If the instrument is fitted with a thermal measuring device, the wiring should be checked and the reduction algorithm tested at known temperatures. In the case of pyrgeometers, all thermistors should be tested.
  - (4) The impedance of the instrument should be checked against the manufacturer's values.
  - (5) Some instruments require desiccant. If so, the desiccant should be fully activated. It is recommended that the desiccating material be of the bead type and not one which easily powders.
  - (6) All connectors must be waterproof and should be appropriate for the climatic conditions in which the sensor will be deployed. For example, in marine environments care must be taken against using connectors that are prone to corrode. It is recommended that keyed connectors be used for greater safety in maintaining instrument polarity.

#### 4.3.3 Mechanical Installation

The primary obstacles in obtaining quality direct beam radiation measurements is the difficulty in pointing the instrument toward the sun. This is not so much a problem in mounting the sensor as correctly installing and operating the tracking device (Section 4.4).

The mechanical installation of the pyrhelimeter or cavity radiometer must ensure that the instruments are firmly attached to the tracker on which they are to be mounted. Care must be taken that the instrument will not shift position throughout the day as the centre of gravity shifts with respect to the mounting brackets. Figures 4.5, 4.6, 4.8 and 4.9 illustrate typical mountings of pyrhelimeters on tracking devices. When installed on a correctly pointing tracker, the combination tracker and instrument should work as an integrated unit with the sight of the instrument acting as the primary sight for the tracker. When using an active tracker, care must be taken to ensure that the pyrhelimeter or active cavity radiometer sights are aligned with the respect to the positioning of the active eye. Trackers that use a combination of active and algorithm tracking (an algorithm that calculates the location of the sun based on location and time) depending on solar intensity, must be set up in a manner that the tracker does not 'jump' to a different position when the solar intensity drops below the active-eye threshold. When both a pyrhelimeter and a cavity radiometer are mounted on the same tracker, the pointing of the cavity radiometer should take precedence over the pyrhelimeter.

It should be noted that in aligning direct beam radiometers, the field of view of the sighting diopter is significantly smaller than the field of view of the instruments. Nominally, pyrhelimeters have a field of view of approximately 5°, while the sighting optic subtends a maximum angle of between 1.4 and 2.0°. Figure 4.7 illustrates how the pointing accuracy of a tracker affects the output signal of the major types of pyrhelimeters used within the network. Annex D details the type of measurement errors associated with the incorrect pointing of pyrhelimeters based on model calculations.

## 4.4 Installation of Solar Tracking and Pointing Devices

Several types of solar tracking devices exist, from the single-axis synchronous motor tracker to the computer-controlled dual-axis active-sensor tracker. Each type of tracker has advantages and disadvantages which must be balanced by the individual researcher before installing the device of choice. Table 4.2 indicates the advantages and disadvantages of some of the more common types of trackers. It goes well beyond the scope of the manual to provide the installation and maintenance

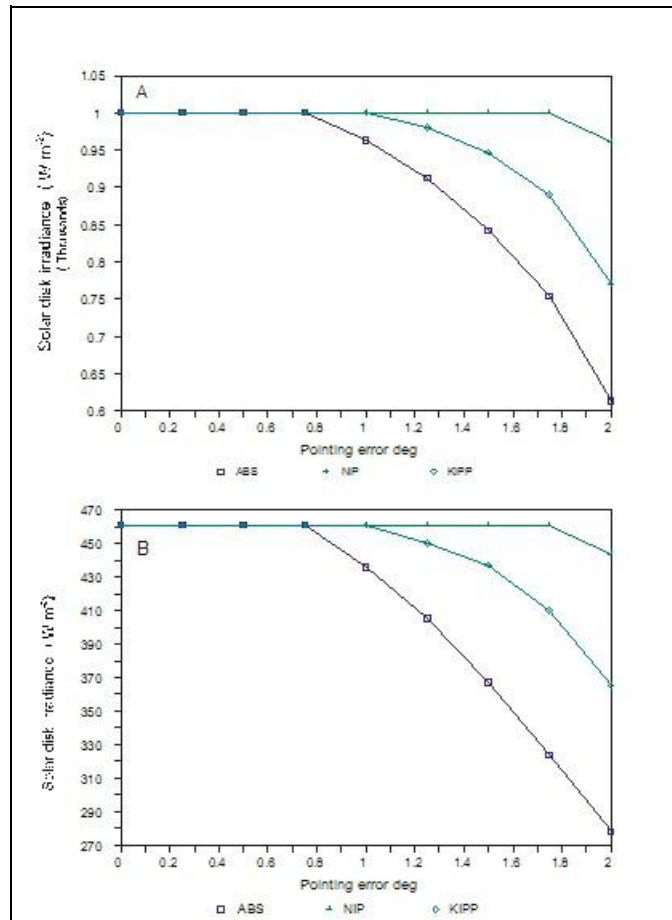

Figure 4.7. The contribution of the solar disk to the irradiance of pyrheliometric sensors depending on the pointing error. (A) Case of mountain aerosol and  $60^\circ$  solar elevation. (B) Case of continental aerosol and a  $20^\circ$  solar elevation. (Calculations and graph courtesy of G. Major)

instructions for each of these devices. A broad overview, however, is important because of the significance solar tracking plays in the measurement of direct and diffuse radiation.

The following general characteristics are common to all solar pointing devices.

- (1) The tracker location must be known. The more precisely the location can be determined, the easier the setup of the tracker. With modern GPS receiver systems the position of the tracker can be determined (latitude and longitude) to within  $\pm 3$  m. From a 1:50,000 topographic map the location can be determined to within better than 50 m. Depending upon the size of the installation care should be taken so that the actual location of the tracker is determined and not simply the central location of the BSRN observatory.
- (2) In all cases a reliable power supply is necessary. Synchronous trackers not only require a constant power supply, as do other trackers, but also a constant and accurate electrical frequency if the tracker is to maintain accurate alignment on the solar disk at all times. Changes in power line frequency will alter the speed at which the solar disk is tracked. Most utility companies are required by law to maintain the power line frequency to some stated accuracy within a 24-hour period with a maximum excursion from that stated frequency at any given moment. Stepper-motor-controlled trackers are less susceptible to such changes because of their internal conversion from AC to DC power. The use of UPS systems on synchronous motor trackers is also of limited utility because many inverter systems output frequency as square waves rather than the sinusoidal wave required by the tracker.

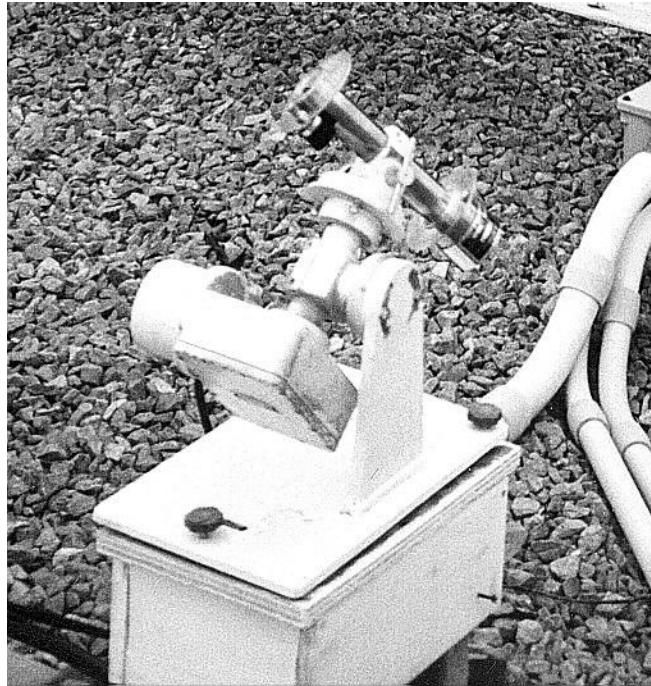

Figure 4.8. A single-axis synchronous motor tracker. This model is an Eppley Model ST-1 Equatorial Mount.

- (3) The base on which the tracker is to be placed must be stable. While active trackers and some passive trackers are able to correct for a non-level surface, all trackers perform better if they are mounted such that the instrument base is level. Trackers mounted on pedestals should be levelled such that the vertical axis of the tracker, and not just the pedestal post, is perpendicular to the horizon. A three-point base that allows easy adjustment is recommended. The use of spring tensioners, lock washers, or bolts that are tightened using double nuts, will reduce the problem of the connection between the mounting post and the tracker base loosening and causing the tracker to tilt from level. The tracker should be rotated about the vertical axis during the levelling process to ensure that the axis is vertical. A number of active-tracking and computer-controlled passive tracking systems are capable of mathematically correcting for out-of-level conditions so that solar tracking is maintained. These corrections, however, do not correct for the tilt error of any pyranometer or pyrgeometer that is mounted

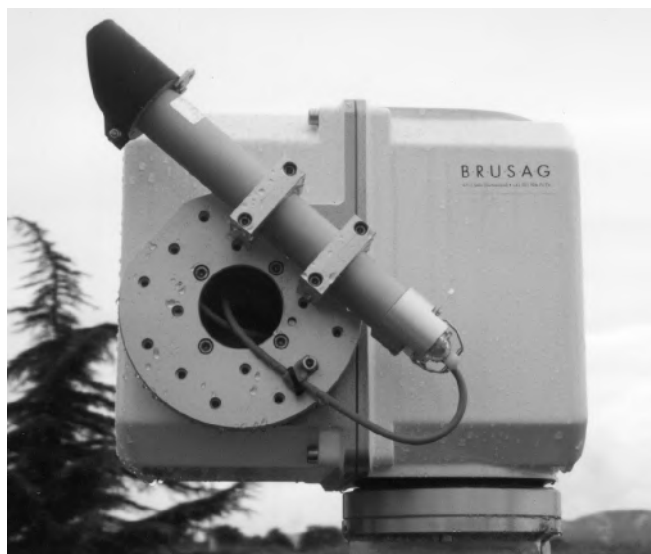

Figure 4.9. Brusag two-axis active tracker. Active tracking is accomplished by balancing the signals from the quadrant sensor that is found on the flat of the elevation disk. The pyrheliometer is a Kipp & Zonen CH1.

on an unlevelled tracker.

- (4) The tracker needs to be aligned in the north-south direction. Depending on the type of tracker the accuracy of this alignment varies. Equatorial trackers need to be precisely aligned, while most two-axes passive and active trackers have correction algorithms built into the software to allow alignment to be less precise. However, the greater the accuracy in aligning the tracker, the easier it will be to initiate accurate tracking. The easiest manner of obtaining a north-south line is to trace the shadow of a perpendicular object at solar noon. Several internet sites are now available that provide such times upon entering the date and the station latitude and longitude (e.g., <http://titan.srb.noaa.gov/highlights/sunrise/gen.html>).

Details on the actual programming and set-up of individual features of the various types of trackers is beyond the scope of this manual and the reader is referred to the technical manuals provided by the manufacturers (Annex E provides a list of manufacturers of solar trackers).

Routine maintenance of solar trackers is can be found in Chapter 6.

<b>Types of Solar Pointing Devices Used in the BSRN</b>		
<b>Tracker Type</b>	<b>Advantages</b>	<b>Disadvantages</b>
Synchronous Motor (Equatorial Mount) Figure 4.8	<ul style="list-style-type: none"> <li>- least expensive</li> <li>- self-contained</li> <li>- very portable (light weight)</li> <li>- easiest maintenance</li> </ul>	<ul style="list-style-type: none"> <li>- single axis requires adjustment for solar declination</li> <li>- pyrheliometer wiring must be untangled every few days</li> <li>- accuracy dependent upon quality of the power line frequency</li> </ul>
Two-axis Passive (algorithm controlled) Figure 4.6	<ul style="list-style-type: none"> <li>- follows solar disk by translating accurate solar position algorithms into stepper motor control functions (using either an internal or external CPU)</li> <li>- usually has larger payload than synchronous motor trackers</li> <li>- does not require untangling of cables</li> <li>- may be able to attach an unshaded pyranometer on the azimuth axis to reduce the azimuth uncertainty</li> </ul>	<ul style="list-style-type: none"> <li>- requires accurate clock for accurate solar tracking</li> <li>- more expensive than equatorial mount</li> <li>- may require a separate computer control system to operate</li> <li>- pointing accuracy and smoothness of position dependent upon stepper motor functions</li> </ul>
Two-axis Active (quadrant sensor controlled) Figures 4.5 and 4.9	<ul style="list-style-type: none"> <li>- similar load capabilities to the two-axis passive tracker</li> <li>- active tracking device overcomes problems with clock accuracy during line-of-sight tracking (added accuracy over algorithm control)</li> <li>- most reliable accurate tracking</li> <li>- may be able to attach an unshaded pyranometer on the azimuth axis to reduce the azimuth uncertainty</li> </ul>	<ul style="list-style-type: none"> <li>- expensive</li> <li>- active tracking eye must be calibrated to ensure proper tracking in complex sky conditions</li> <li>- may require a separate computer control system to operate</li> <li>- requires accurate clock during cloudy conditions to maintain accurate solar tracking</li> <li>- pointing accuracy and smoothness of position dependent upon stepper motor functions</li> </ul>

Table 4.2. Advantages and disadvantages of common solar tracking instruments.

## 5.0 Data Acquisition

### 5.1 Introduction

Installing and maintaining the network data acquisition system(s) is crucial if consistent high quality radiation data is to be sent to the archive. Within this manual *data acquisition system* (DAS) means those electronic devices (including the controlling software) and the connectors, which carry out the process of measuring the signals emanating from the radiation and ancillary measurement devices (transducers).

A DAS designed for operating and recording data from automated laboratory equipment is generally suitable for radiation measurement. Usually, these systems consist of four components:

- (1) the multiplexer sequentially switches across a number of input channels, each of which is connected to one of the transducers that are to be measured.
- (2) the analog-to-digital converter (ADC), that converts the analog signal (e.g., voltage, resistance) into a digital signal.
- (3) the recording system, which may be a combination of internal and external, buffers and permanent storage locations
- (4) the controlling computer(s), both internal and external, that handle sending control signals to the multiplexer, the ADC and the storage based upon the user's commands.

These may be combined into a unit, may be separate units connected, for example, by a General Purpose Interface Bus (GPIB) instrument bus (e.g., HP, Fluke), or may be on a card that plugs into a PC that is used as the overall control unit. Each of these arrangements has their own advantages and disadvantages. The combined system is more compact and the programming may be easier. A system with a separate computer may allow for easier data analysis by allowing it to be accomplished on the same computer. Those that are totally separate normally have higher accuracies than combined or PC card systems and can be more easily updated if required.

Although the number of data acquisition or data logging products on the commercial market is enormous, many do not meet the exacting specifications required by the BSRN. Annex F lists the names and addresses of companies that can provide systems that will meet the general requirements imposed by the BSRN. The most stringent of these requirements is the accuracy requirement of 1  $\mu\text{V}$  on a 10 mV signal (0.01%) and the need to make 60 measurements per channel per minute. Within the system, the two major components that must be carefully considered with respect to accuracy and timing are the multiplexer and the ADC.

Multiplexing is accomplished either by magnet operated relay contacts or by semiconductor switches. Relay multiplexing is better for radiation measurement because the relays contribute very little noise (1-2  $\mu\text{V}$ ). Unfortunately, some relay equipped systems are slow. Conversely, semiconductor multiplexing systems are much faster, but the noise or offset voltage may be greater than 15  $\mu\text{V}$ . In either case, settling time is required before the measurement can be made.

In considering the ADC, the type and time of integration, the number of bits of resolution and the linearity must all be considered. High-end, bench-type digital multimeters (DMM) are now capable of 24-bit resolution and uncertainties of 10's of ppm under stable operating conditions. More rugged systems usually consist of either 12 or 16 bit ADC. The former does not provide the resolution, without regard to the accuracy, required for the BSRN, while the latter still may not meet the accuracy requirements. In cases where the resolution is fixed to a 5 V scale, but the accuracy is adequate with respect to full scale, the addition of a high quality instrument pre-amplifier at the transducer end of the signal can increase the magnitude of the signal to a level where the DAS can meet the BSRN requirement. In such cases though, the overall accuracy of the system is a linear combination of the uncertainties of both the DAS and the pre-amplifier. (A cautionary note: resolution does not equal accuracy).

Another means of reducing uncertainty for systems that otherwise meet the resolution and timing requirements is by calibrating individual data acquisition systems and then correcting for any nonlinearity etc. found within the DAS. This process, while possibly saving capital funds, can be labour intensive and requires that the DAS be calibrated under the conditions associated with the measurement regime.

Of secondary importance in the selection of the DAS is its programmability. While the minimum requirement for the DAS is to measure a set of signals with a 0.01% accuracy at 1 Hz, the output to be archived is the one minute mean, minimum, maximum, and the standard deviation. Thus one can store the second data and post process the results or use the features associated with the DAS. In overall storage requirements and operator ease, the programmable DAS is the more attractive option.

## **5.2 Set-up Considerations**

Depending upon the location of the instruments, the accessibility of laboratory space and the overall climatic conditions, the installation of the DAS may be near the instruments (within 5 m) or somewhat distant inside a laboratory. The ideal site would have a completely climate-controlled building within a few metres of the instruments (e.g., rooftop measurements with a laboratory below). When this does not occur, the decision must be made as to what will provide the higher quality data; the use of a robust data logger near the instruments or increased cable length to reach a bench model DAS.

Having a data system that functions in all environmental conditions eliminates the problems of signal loss along cables and the potential of electrical interference. However, the design and/or operation of a robust outdoor system usually involves some sacrifice in measurement frequency and/or data availability and/or accuracy.

For increased quality control it is recommended that the DAS be one that has the capability of displaying measured data (either in raw or engineering form) in near real time (e.g., within 2 minutes), preferably graphically. The station operator should be able to examine, anytime, both the instantaneous measurements and the data acquired during the preceding few hours or even the last day. With recent developments in serial communications and scientific display software for PC's, this can be easily accomplished with both types of DAS.

Whatever the choice, internally or externally housed, the DAS must be both secure and easily accessible - secure against inadvertent reprogramming or physical harm and accessible for easy maintenance and changes in software or signals. It is highly recommended that a secondary external power supply be used as insurance against loss of primary power. This may include an uninterruptable power supply (which will also reduce the possibility of damage from power surges) for bench and computer-style acquisition systems and a secondary battery or battery charger connected to the main battery of systems developed to operate on DC power.

The operator must consult the manuals provided by the DAS manufacturers for the specific set-up requirements of the system. When several different products are purchased, it is preferable that they are bought from the same supplier as a package to alleviate the problem of attempting to determine which one of several products is in conflict during the initial installation.

## **5.3 Standard Practices**

- (1) Each signal should be connected as a differential input to ensure the greatest measurement accuracy.
- (2) The minimum integration time for radiation signals should be one power line cycle to eliminate powerline frequency noise.
- (3) Every two years: Calibrate the ADC in an accredited standards' laboratory. This is important even if constant voltages and resistance are input into the system on a continuous basis (see below). Check the associated multiplexer for changes in noise levels and settling time and repair or replace as required.

## **5.4 Suggested Practices**

- (1) Test the pyranometer input to the data acquisition system.
  - (i) Measure the electrical zero. This test should be done near the location where the pyranometer is to be placed to ensure that the cabling is free from induced signals. Disconnect the pyranometer and replace it with a resistor of about the same value as the pyranometer resistance. Check that the voltage reading is zero to the accuracy specified for the data acquisition system. If not, determine whether the output is due

to a fault in the system by performing the same zero test with the resistor attached directly to the input terminal of the unit. Servicing by authorized personnel is required if the data acquisition unit fails. If the unit does require servicing it is also a good opportunity to have the unit calibrated, a procedure that should be repeated every two years. If the problem is not found in the data acquisition unit, it must be assumed that local conditions are causing electrical interference. The cabling should be rerouted and the test repeated. Interference can be reduced by keeping signal cables away from power cables. It is good practice to avoid parallel routing and to intersect all cables at 90 degrees whenever possible.

- (ii) Measure the lead resistance. Short the resistor and measure the resistance of the leads as seen by the data acquisition system (a bridge circuit may have to be built for this test depending upon the capabilities of the system). The resistance should be less than 10 ohms. If the resistance is satisfactory, the resistor (and bridge) can be removed from the circuit and the pyranometer returned. If the value is excessive, determine if this is a result of the length of the cabling. This can be accomplished by calculating the overall resistance of the cable by either measuring a short length of similar cable or obtaining the specification of resistance per unit length from the manufacturer. Once the unit length is obtained, an approximate value of the entire length can be calculated. If the resistance can be attributed to the length of the cable one can account for the commensurate loss in voltage when the measurement is converted into engineering units. If the resistance is greater than indicated by the length of the cable, it is caused by a fault within the cable. This must then be repaired or replaced.
- (iii) Test the complete system. Measure the resistance of the pyranometer as installed with the data acquisition system and check that it is approximately within the manufacturer's specification. This has to be done at night or with the dome covered unless the resistance measurement is in the offset compensation mode in which case it would be unaffected by the pyranometer signal voltage.

## (2) Installation of constant signals

For greater assurance in the reliability of the data, channels should be set aside to be used with known signals in the same range as those signals being measured. For example, on a system where both resistance and voltages are being measured, a fixed resistor and a known voltage should be included as part of the sampling sequence. These provide a means of rapidly flagging any changes in the quality of the measurements. Obviously, in a multiplexed system, the potential exists for scanning problems being missed.

## (3) Instrument resistance checks

An easy means of determining a fault in cabling or a sensor which outputs a voltage is testing for changes in the resistance. On programmable systems, it is encouraged to test the resistance of each sensor on a daily basis to determine if any significant changes have occurred in the overall resistance of each channel. While a trained operator may observe changes in a signal associated with a broken wire or instrument, floating channels are not necessarily easy to detect immediately if they are not well defined (e.g., pyrometer voltages) or adjacent to a channel with a similar signal.

## (4) Programmable flagging

If the system is capable of automatic data quality checks, it should be programmed to set flags when:

- (i) any irradiance values fall outside the range  $-10 < E < 1200 \text{ W m}^{-2}$ . The program should not be designed to delete any data automatically.
- (ii) any air temperature value (air, case, dome, etc.) is outside the normal climatological range of the station by greater than  $\pm 10 \text{ }^\circ\text{C}$ . The program should not be designed to delete any data automatically.

## 6.0 Maintenance

### 6.1 Introduction

High quality, consistent on-site maintenance is crucial if accurate long-term records are to be obtained. Not only does the individual have to care for the instruments, they must also carefully document any work that they do on those instruments. It is not good enough to assume that instruments are cleaned regularly; this activity must be properly documented. To help in this documentation, sample log sheets are reproduced in Annex G. Many national networks have developed their own methods of documentation and these can be used if they contain the appropriate information for the radiometers. **ALL MAINTENANCE PROCEDURES, VARIATIONS IN INSTRUMENT BEHAVIOUR AND CHANGES IN INSTRUMENTATION MUST BE FULLY DOCUMENTED WITH RESPECT TO ACTIVITY, TIME AND DATE.**

### 6.2 Daily Maintenance

The minimum daily requirements for maintaining a BSRN radiation station are as follows:

(1) Cleaning:

- (i) *Active Cavity Radiometers:* Radiometers fitted with a protective optical flat should be cleaned using a soft cloth and/or a photographer's airbrush. Material adhering to the surface of the optical window should be removed using a soft cloth dampened by either deionized water or methyl hydrate (or equivalent). If the window is other than glass or quartz, the type of solvent used for cleaning the material must be checked before applying it to the surface. Care should be taken to ensure that no build-up of material is found at the border of the flat with the flange holding it on the instrument. When cleaning with any type of liquid, it is essential that no film or residue be left on the surface. The general procedures outlined below should be followed if frost or ice is on the window.

For cavity radiometers without protective flats the area around the opening aperture should be inspected and any foreign material should be brushed away from the opening.

- (ii) *Pyranometers and Pyrhemometers:* The exterior of domes or optical surfaces of each instrument must be cleaned at least once per day. It is preferable that this cleaning is done before dawn. However, if this cannot be accomplished, the sensors should then be cleaned as early as possible during the day. If possible, the instruments should also be cleaned following the occurrence of any form of precipitation or atmospheric events that would cause degradation to the signal. Each time an instrument is cleaned, the time and duration of the cleaning should be recorded in the site documentation.

All loose dust or particulate matter should be blown off gently (a camera brush is a useful tool) before the dome is wiped. Using a soft lint-free cloth the dome should then be wiped clean. If any matter is adhering to the dome, either deionized water or methyl hydrate (or equivalent) should be used to wet the cloth before cleaning the dome. Do not pour the liquid onto the dome directly. Caution must be used so that the dome is not scratched, nor the instrument moved, during this procedure. Any film left from the cleaning material must be removed.

Several methods may be used to remove frost or ice from the dome, depending upon the severity. Light deposits can be removed by lightly rubbing the surface using the lint-free cloth as in normal cleaning. Heavier deposits can be removed by using a methyl hydrate solution on the cloth. Where an ice build-up cannot be removed with methyl hydrate alone, the observer (depending on weather conditions) can melt the ice by placing his hand on the dome. In severe cases a hand-held hair dryer can be used. In the most severe cases the instrument should be removed and brought inside to thaw. Using any sharp objects to chisel away the ice is NEVER appropriate. In cases where the ice is melted by whatever means, the dome should be cleaned with methyl hydrate and then wiped with a clean lint-free cloth following the operation. The procedure used and the time required should be documented.

While cleaning the dome, an inspection should be made to decide whether any scratches or chips have occurred since the last cleaning. Such marks are made by scouring of

the radiometer dome by sand or by hydrometeorites such as hail. If the dome is damaged, it should be replaced with one made of the same optical material. The change should be documented and the dome kept for future reference. Although domes do not normally change the overall calibration of the system, the instrument with the new dome should be monitored for any differences, particularly changes in directional responsivity.

- (i) *Pyrgeometers*: Daily cleaning of the dome of the pyrgeometer should take place when the other instruments are cleaned. Particulate residues should be removed using a soft brush or gentle airstream. The dome can be wiped with a lint-free cloth. In cases where material has adhered to the dome, a cloth moistened with deionized water can be used.
- (2) The radiometer should be checked for any condensation on the inside surface of the outer dome. If this occurs, the outer dome must be removed in a clean, dry location, cleaned and the cause for the leak determined. The most probable cause is poor maintenance of the desiccant (see weekly maintenance). If the desiccant has been changed within a week, the probable cause is a poor 'O' ring seal. A replacement is required. If moisture is found on the inner surface of the inner dome, the instrument should be replaced with a spare instrument and the faulty instrument sent for service.
- (3) The colour and the condition of the thermopile should be checked. If the colour is fading or changing; or the thermopile surface appears rough, cracked or weathered; the instrument should be removed from service and replaced with a spare. On newer instruments this occurs rarely.
- (4) The level of each horizontally mounted instrument (e.g., pyranometers, pyrgeometers) should be checked and corrected as necessary. The bubble of the circular level should be completely within the inner circle. For most instruments, this indicates that the instrument is level to within  $\pm 0.1^\circ$ .
- (5) The cabling leading from the instrument to the data acquisition system or junction box should be inspected for wear. Unless the cable is to be replaced, or must be untangled, the instrument should not be disconnected. All work on the cable should be appropriately documented. In cases where a cable is functional, but aging, a time should be set for its replacement during the station semiannual or annual maintenance (see below).
- (6) The ventilator motors should be checked on a daily basis. If the motor is not operating properly, the problem should be corrected or the motor replaced. All procedures should be documented, including the start and end time of the work. If knowledge of when the ventilator began to malfunction is known (e.g., lightning strike) this should also be included in the log. On those ventilators where the cover acts as a radiation shield, the top of the cover must be situated below the receiver surface of the radiometer.
- (7) The pointing of any instruments should be checked and, if necessary, corrected. The reasons for possible misalignment are partially dependent on the type of tracker being used. The sun must be shining to detect spot alignment for direct beam instruments; however, the checking of clock times and general system failures is independent of weather conditions.
  - (i) *One-axis solar tracker*
    - the solar declination must be checked and adjusted to align the solar spot with the instrument target.
    - as most one-axis trackers use synchronous motors, the power frequency must be monitored to ensure that the tracker is being driven at the correct speed.
    - the tracker must be inspected to ensure that no mechanical malfunction has occurred (e.g., slippage in the clutch)
    - In one-axis trackers, unless especially equipped, the cables attached to the instruments must be manually unwound each day.

(ii) *Two-axes passive solar tracker*

Passive trackers use either internal or external computers to calculate the position of the solar disk. Following the initial setup of the system, tracking of the solar spot by the shading disk or the instrument attached to the tracker should not normally vary except when the power is removed from the tracker and/or the computer operating the tracker, or when the time used to calculate the solar position is incorrect.

- check that the clock time used in the calculation of solar position is accurate to better than 15 seconds for tracking of instruments with a 2° field of view or greater. The smaller the FOV, the greater the time accuracy required.

- on days when the solar spot is visible on the target, check tracker alignment. If not aligned follow the procedures below and/or in the manual.

- determine if the power to the tracker has been disrupted either at the main power panel or within the cabling to and within the tracker.

- for friction-driven drives check for slippage of the drive disks (see the tracker operating manual for the proper procedure).

- for gear-driven drives, if slippage occurs, check gear alignment or if one or more gears have broken teeth (see the tracker operating manual for proper procedures).

- check to ensure that the tracker has not changed its physical position, either in level or location (e.g., the tracker has not been bumped accidentally).

- a tracker mechanical malfunction or software failure can also cause a loss of tracking capability. The operator should refer to the tracker operating manual in such cases.

(iii) *Two-axes active solar tracker*

An active tracker corrects for small variations in the pointing of a passive system. Such a system requires that the tracker not operate in active mode during periods where the solar signal is below a defined solar irradiance threshold. During such periods, the active tracker should operate in a mode similar to a two-axes passive system. Following the initial setup of the system, tracking of the solar spot by the shading disk or the instrument attached to the tracker should not normally vary except when the power is removed from the tracker and/or the computer operating the tracker.

- clean the active sensing unit on the tracker daily and following occurrences of precipitation.

- check that the clock time used in the calculation of solar position is accurate to better than 15 seconds for tracking of instruments with a 2° field of view or greater. The smaller the FOV, the greater the time accuracy required.

- on days when the solar spot is visible on the target, check tracker alignment. If not aligned follow the procedures below and/or in the manual.

- determine if the power to the tracker has been disrupted either at the main power panel or within the cabling to and within the tracker for a time greater than that which the active sensing unit can correct.

- check the operation of the active sensing unit. This can be accomplished by covering the active sensor and manually positioning the tracker to within the acceptance limits of the active sensor with the power turned off. By turning on the power to the tracker (ensuring that any computer programs are operating correctly) the active sensor should move the tracker into correct alignment. If this does not occur, technical assistance in further checking the operation of the active sensor is required.

- for friction-driven drives check for slippage of the drive disks (see tracker operating manual for the proper procedure).
- if slippage occurs on gear driven trackers, the gears should be inspected for missing teeth and the gear alignment tested (see tracker operating manual for proper procedures).
- check to ensure that the tracker has not changed its physical position, either in level or location (e.g., the tracker has not been bumped accidentally).
- a tracker mechanical malfunction or software failure can also cause a loss of tracking capability. The operator should refer to the tracker operating manual in such cases.

The operator should always note the position of the solar spot on the pyrhelimeter or cavity radiometer before any adjustment is made. Following the adjustment, the new location of the solar spot should be noted. The time required to make the adjustment and the details of what caused the failure to track and its correction should also be documented.

#### (8) Cavity Radiometers

- (i) *All-weather instruments:* Cavity radiometers modified for continuous use should be checked daily to ensure that all safety features are operating properly. These might include such items as automatic shutters, rain sensors or fan switches. The manufacturer's operating manual should be consulted. Fans in continuous operation should be checked for proper operation.
- (ii) *Fair-weather instruments:* Instruments operated during fair weather conditions must be checked for proper alignment and correct signal and power connections as part of the set-up procedure. Shutters should be checked to ensure correct operation before measurements begin. Following use, the exterior of the instrument should be wiped down and the entire instrument inspected for any damage, including the lodging of any insects within the instrument cavity. If the instrument is moved into a heated enclosure following the measurement period, care should be taken to avoid moisture condensing in the cavity. Although the transducer coating is not water soluble, over time, chemical constituents within the condensing liquid can cause changes in the absorptance of the coating. Cleaning of the sensor should be done only by qualified personnel.

#### (9) Shaded Instruments - Diffuse Irradiance, Infrared Irradiance

Each shaded instrument must be checked to ensure that the shading device completely covers the outer dome of the instrument. These checks are similar to those above for the direct beam instruments.

#### (10) Data acquisition/computer systems

The system collecting the data should be checked to ensure that it is operational. The operator, in conjunction with the site scientist, should devise appropriate methods to decide whether the system is operational. Simply looking at a computer screen is NOT sufficient. Tests should be devised to detect that data are being acquired successfully, that the time stamp is correct and that the system has not malfunctioned since the last check.

A correct system time is crucial because data are being obtained at one second intervals. Unfortunately, many PC compatible computers have very poor clock systems. Each day the clock offset should be recorded and the time corrected if this offset is greater than one second. If the clock varies by more than 10 seconds per day, a new clock should be installed. A system changing at a rate of less than one second per month would be ideal (see section 2.3.1).

- (11) Where possible, the site operator should be able to review the data from the previous day. This information will allow him/her to detect any significant changes that may have occurred during the day. An example of such a change would be a passive tracker that was not level. During the morning when the observer checks the shading of instruments it would be found correct, but during the afternoon the diffuse flux would increase because of the shading disk moving off the sensor.

### 6.3 Weekly Maintenance

The minimum weekly requirements for maintaining a BSRN radiation station are as follows (in addition to the daily maintenance):

- (1) Check the desiccant in each sensor. Desiccant should normally last several months, but is dependent upon atmospheric water vapour, the quality of radiometer seals, the size of the desiccant chamber and the quality of the desiccant. In drier climates checking the desiccant monthly may be sufficient while in areas where monsoon conditions occur, twice weekly inspections should be made during the most humid season. Depending upon the type of sensor and the type of ventilated housing, the shield portion of the ventilator may require removal to check the desiccant. Once checked and replaced if necessary, the shield should be carefully replaced ensuring that the top of the shield is below the level of the instrument receiver surface. Whenever possible, desiccant should be changed during conditions of low relative humidity.

If the desiccant is not a bright blue/purple, it should be changed. Desiccant can be recharged by drying. Therefore, no saving is gained by attempting to have the desiccant last another week. The material removed from any instruments should be saved and re-activated by placing in an oven at a low heat for several hours. The desiccant will return to its original colour when dry. Desiccant should be stored in an air tight container.

- (2) If not part of the normal data acquisition program, the resistance of each of the instruments should be checked and recorded. Significant changes in resistance can be used to detect system faults.
- (3) If not part of the normal data acquisition program, a reference voltage source and reference resistor should be used to test the stability of the response of the data acquisition system. This should be repeated at various temperatures to determine the effect of temperature changes on the data acquisition system when such systems experience temperature extremes (e.g. data loggers kept in unheated outdoor enclosures).

### 6.4 Long-term maintenance

#### 6.4.1 Semi-annual maintenance

- (1) The pyranometers used for the measurement of global and diffuse radiation should be swapped. For more information please see Section 8.3 on calibration.
- (2) The pyrgeometer should be replaced for calibration. For details please see Section 8.4 on calibration of pyrgeometers.
- (3) Any wiring that has become cracked or brittle should be replaced. Any connectors that have begun to corrode should be replaced.
- (4) A careful inspection of all instruments should be made to determine aging. If radiation shields etc. have begun to show signs of aging (brittleness, discolouration etc.) they should be replaced. Pyranometers should be checked for excessive weathering, O-rings checked and lubricated etc.
- (5) All-weather housings for cavity radiometers should be cleaned and any internal electrical connections checked and repaired as necessary. All weather-tight seals should be checked, lubricated or replaced as appropriate. Fans motors should be checked and lubricated or replaced as necessary. Any other moving parts should be checked and lubricated according to the manufacturer's recommendations.
- (6) Some trackers require semi-annual maintenance. Check with the manual provided with the tracking device to determine these requirements.
- (7) All seals in weather-tight enclosures should be checked and lubricated or changed if necessary.

#### 6.4.2 Annual maintenance

Ideally, the annual maintenance should take less than one day to complete if a team of workers is present. Although unlikely, it would be best done while the sun is below the horizon.

- (1) Calibration of the cavity radiometer (see Section 8.2.1).
- (2) All field support assemblies should be checked for level and structural integrity.
- (3) All bolts should be loosened, lubricated and tightened. This preventative maintenance is especially important in areas of harsh climate where corrosion may occur.
- (4) Fans used in ventilated housings should be lubricated or replaced (depending on the type of system in use).
- (5) Calibration of the digital voltmeter (or equivalent) used in the data acquisition system. Because of the complex nature of system testing and calibration (it is not just placing a known source on the input terminals) this procedure should only be done by qualified personnel, either associated with the metrology laboratory of the institution operating the BSRN station or the manufacturer. The calibration should be traceable to a national standards institute. It is recommended that one or more spare units be obtained so that during a calibration a newly-calibrated spare unit can replace the unit being calibrated.

## 7.0 Measurement of Aerosol Optical Depth

### 7.1 Introduction

The monitoring of aerosol optical depth (AOD) has been considered an important, but difficult, observation that is necessary if there is to be an increase in understanding of the surface radiation budget. While the optical depth provides information on spectral atmospheric extinction, a number of inversion algorithms have been developed to use this information to produce data on the columnar aerosol number-size distribution, volume distribution and concentration. Along with other measurements of the solar aureole and almucantar the data has also been inverted to provide information on aerosol absorptivity. By measuring, or more normally assuming, a change in aerosol concentration with height above the surface, these optical properties can be used to better understand the radiative regime of the atmosphere. Over time, more and more user communities have expressed the need for this type of data. Several global and regional aerosol measurement networks have been established in response to this need. The two most significant of these, with respect to the ongoing work of the BSRN are the Global Atmosphere Watch (GAW) sunphotometer network, which is being established at global background stations, and the NASA Aerosol Robotic Network (AERONET)<sup>13</sup>.

At the inception of the BSRN the importance of aerosol optical properties on the radiation budget was recognized and the BSRN Archive was designed to include values of spectral AOD<sup>14</sup>. The sunphotometers available in the early 1990s were found to be too unstable and the measurement protocols unacceptable to determine changes in global and regional climates, as was the mandate of the BSRN. Instrument instability was due in large part to the rapid aging of the interference filters used in the instruments, especially at shorter wavelengths, while many measurement protocols consisted of only a few measurements per day because they were designed around the use of handheld instruments. Changes in instrument design, including the reduction of the exposure time of filters to UV radiation and the stabilization of instrument temperature have improved the performance and stability of new instruments. Accurate tracking systems have improved the repeatability of observations by decreasing pointing uncertainty, while the increase in sampling frequency provides a means of tracking changes in instrument and atmospheric conditions that could not be accomplished with only several or even tens of observations per day.

At the 6<sup>th</sup> BSRN Science and Review Workshop<sup>15</sup> the Working Group on Aerosol Optical Depth proposed, and the BSRN accepted, specifications related to AOD measurements. The objective of the BSRN measurement program is to provide AOD measurements at selected wavelengths between 360 and 1100 nm with an uncertainty no greater than 0.01 under near ideal conditions, decreasing to no greater than 0.02 for all conditions when water clouds do not interfere with the direct line-of-sight to the solar disk.

The calculation of AOD, although straightforward in principle, varies because of the number of approximations that are used in its calculation. Small differences in the methods used to calculate sun-earth distance, Rayleigh optical depth, or the ozone absorption coefficients and scale height all increase the overall uncertainty in the calculation of AOD. Individual differences between methods of calculation alter the overall AOD. In combination, one set of algorithms, compared to a different set will act as a bias. This will be of greater significance to the determination of small AODs, as measured at background stations, than those in more turbid areas. The Working Group on Aerosol Optical Depth Measurements determined that because of the possibility of such discrepancies, the submission of AODs to the archive could not provide users with an accurate long-term, spatially diverse database. Therefore, it was decided that spectral transmission data, with ancillary information, be transmitted to the BSRN Archive. The archive would then calculate the aerosol optical depth using a common set of algorithms. Once determined the algorithms will be made available to BSRN scientists, but all

---

<sup>13</sup> Holben, B.N., T.F.Eck, I. Slutsker, D. Tanré, J.P. Buis, A. Setzer, E. Vermote, J.A. Reagan, Y.J. Kaufman, T. Nakajima, F. Lavenue, I. Jankowiak, and A. Smirnov, 1998: AERONET - A federated instrument network and archive for aerosol characterization. *Rem. Sens. Environ.*, 66, 1 - 16.

<sup>14</sup> Gilgen, H., C.H. Whitlock, F. Koch, G. Müller, A. Ohmura, D. Steiger, R. Wheeler, 1995: *Baseline Surface Radiation Network Technical Plan for BSRN Data Management (Version 2.1)*. WCRP WMO/ITD-no. 443.

<sup>15</sup> World Climate Research Programme, 2001: Report of the Sixth Science and Review Workshop, Melbourne, Australia, 1 - 5 May 2000 (Annex IV). WCRP Informal Report No. 17/2001.

AOD values obtained from the archive would continue to be based solely on the submitted transmission data.

## 7.2 Instrument and Wavelength Specifications

### 7.2.1 Instrument Specifications

Historically, sunphotometers have been designed as either single detector instruments that use a rotating wheel to place a filter between the opening aperture and the detector, or instruments that measure each bandwidth by matching a detector and an interference filter in its own optical frame. Newer instruments are now being developed that use prisms or gratings to separate the solar spectrum and detector arrays are being used to measure the spectral intensity. Each of these methods have advantages and disadvantages that should be studied before a particular type of instrument is purchased or built. As with the radiation sensors, the type of spectral radiometer used at individual BSRN sites for the measurement of aerosol optical depth is the responsibility of the principal scientist. The choice should be based upon achieving the lowest measurement uncertainty possible, but never greater than the BSRN guidelines. Several commercial instruments are presently available that can be configured to meet the present specifications (see Annex B5), but noncommercial research instruments that meet these minimum requirements are fully acceptable. To encourage instrument development, radiometer specifications have been limited to the following:

- (1) The instrument Field-of-View (FOV) must be less than  $2^\circ$  for radiometers that use a lens to focus the solar image or have an opening angle of less than  $2.5^\circ$  and a slope angle of no greater than  $1^\circ$  for instruments without optics
- (2) The instrument, or instrument in combination with a solar pointing device, must track the solar disk to better than  $0.1^\circ$ .
- (3) The stability of the detector must be better than 0.5% per annum at a nominal temperature of  $25^\circ\text{C}$ . This is separate from changes in the spectral bandpass (see below),
- (4) The detector should be temperature stabilized with a temperature-related drift of less than 0.1% over the complete range of temperatures at which the instrument is to be operated. If the temperature cannot be stabilized, then the characteristics of the detector must be known and corrected. The efficiency of typical silicon photodiode detectors can change by more than  $-0.5\% \text{ }^\circ\text{C}^{-1}$  at wavelengths less than 350 nm and by more than  $0.5\% \text{ }^\circ\text{C}^{-1}$  at wavelengths greater than 950 nm. The typical temperature response for wavelengths between these is  $-0.2\% \text{ }^\circ\text{C}^{-1}$ .
- (5) As in (4) the temperature of the filters must either be stabilised or monitored to ensure that temperature related shifts in the wavelength do not exceed the specifications set out below. It is recommended that the filters be temperature stabilised to reduce cycling of the passband with temperature. Typically the change in the peak transmittance of an interference filter is  $\sim 0.01\% \text{ }^\circ\text{C}^{-1}$  and the central wavelength increases by 0.01 - 0.03 nm  $^\circ\text{C}^{-1}$ . Daily temperature variations could thus alter the central wavelength in the order of 0.6 nm and seasonal temperature variations in continental climates could shift the central wavelength by more than 2 nm between cold and warm season extremes.

### 7.2.2 Wavelength Specifications

The following specifications have been adopted by the BSRN and have followed, to a large extent, the recommendations of the World Optical Radiation Calibration Centre (WORCC). The major exception is the selection by the WORCC of passbands centred on  $\text{H}_2\text{O}$  and  $\text{NO}_2$  absorption bands. The selection criteria of the four primary wavelengths for the BSRN are that they are in relatively flat areas of the solar spectrum and away from water vapour or trace gas absorption. The major exception to the selection criteria is the choice of the 500 nm waveband. This was selected because for historical reasons.

The actual central wavelength must be determined to better than  $0.3^\circ$  and the out-of-band rejection should be at least  $10^{-4}$  for a minimum of  $\pm 40$  nm from the central wavelength. In all cases, but especially for filters in the UV, the transmittance of the filter should be tested over the entire spectral range of the detector. In cases where out-of-band rejection is less than  $10^{-4}$  beyond 40 nm of the central wavelength, longpass or shortpass blocking filters should be used as appropriate.

Table 7.1 lists the BSRN wavelengths, maximum displacement from the nominal wavelength and the maximum waveband (Full Width at Half Maximum) in order of priority.

Nominal Wavelength (nm)	Maximum Displacement (nm)	Maximum Bandwidth FWHM (nm)	Wavelength Mandatory	Absorption
412	2	6	Yes	NO <sub>2</sub>
862	4	6	Yes	
500	3	6	Yes	O <sub>3</sub> , NO <sub>2</sub> (minor)
368	2	6	Yes	NO <sub>2</sub>
778	2	11		
675	3	11		O <sub>3</sub>
610	2	11		O <sub>3</sub>

Table 7.1. Spectral passband information for BSRN aerosol optical depth measurements.

The absorption of NO<sub>2</sub> is of minor consequence in remote or rural areas, but should be accounted for when AOD measurements are made in urban areas.

The use of additional spectral bands, for the determination of atmospheric constituents or increased information on aerosol optical properties, is encouraged. Aerosol properties, however, will only be archived for these selected wavelengths at present.

The changing transmission and the rapid shifting of the central wavelength in interference filters that have been used in sunphotometers have caused the rejection of large amounts of data and brought even more data under suspicion. The manufacture of interference filters has improved over the last decade. Filters produced, using ion deposition technology, should be more stable than those made using older technologies. The use of these filters has not yet been proven, however. Several procedures have been found to reduce filter degradation:

- (1) Sealing the radiometer from the ambient environment. Filters have been found to degrade more slowly when the instrument is temperature controlled and the humidity is controlled.
- (2) Ensuring that the filters are exposed to solar radiation only during times when observations are being made. This can be accomplished either by using a shutter to block radiation from hitting the surface of the filter, or by turning the opening aperture away from the radiation source.
- (3) Filters have been found to degrade from the outer edge inward toward the centre. Therefore, the use of oversize filters will prolong their useful life.

Even with these precautions, the transmission and waveband properties should be checked regularly. The use of the "ratio-Langley" method (Section 7.4.2.2) provides a means of checking for variations between wavelengths that may be caused by changes in the optical properties of the interference filters. If changes do occur, the instrument should be carefully checked to determine the cause of the change (multi-detector instruments may be showing changes in sensor responsivity). In cases, such as above, and during times when the instrument is in an optical laboratory, the interference filters should be carefully removed from the instrument and their optical properties measured using a high-quality bench spectrometer. If changes in the bandpass are found so that it no longer meets the requirements set out in Table 7.1, the filter must be replaced. The filter transmission may also vary with age. The principal investigator must determine whether the change in transmission is enough to require the filter be changed.

The tolerance provided by most filter manufacturers is such that obtaining identical filters over a period of years is unlikely. Therefore, if possible, spare filters should be purchased at the same time as the

original filters and from the same manufacturing lot. In this manner, the waveband characteristics can be maintained over longer periods of time.

## 7.3 Data Acquisition

### 7.3.1 Sampling

Observations are to be made at a frequency of once per minute. Unlike other irradiance observations that obtain one-minute averages, the measurement of direct spectral irradiance is to be an instantaneous observation at a given time ( $t$ ). When multiple measurements are made with a single-detector instrument or as part of a large set of observations, the difference in time ( $\partial t$ ) between the first and last observation must also be known. If multiple instruments are to be used, both  $t$  and  $\partial t$  must be known for both instruments, and the observation times must be synchronized.

The dark (or zero) signal should be measured for each transducer as part of the observation sequence when possible. For instruments that are not capable of obtaining a dark signal with each observation, dark signals should be measured at night, or a sampling scheme should be designed so that a dark signal is measured at least daily. This may be as simple as blocking the entrance aperture of the instrument during an observation time.

Measurements should continue throughout the period that the sun is above the local horizon (see Section 3.1.2). The sampling program must not automatically screen observations because of cloud or other forms of contamination.

The use of sampling frequencies of less than once per minute will be accepted into the archive until 2004 for automated instruments that meet all other BSRN specifications.

Measurements obtained from handheld sunphotometers will not be accepted by the archive.

### 7.3.2 Data Acquisition

Depending upon the radiometer, the data acquisition system may be part of the instrument package. Other radiometers require separate instrumentation for data collection. In all cases, the collection system must be capable of providing:

- (1) A signal-to-noise ratio no less than 5000:1 for the smallest output signal of the spectral irradiance channels measured when the sun is at its highest elevation for the station. In high turbidity cases ( $Ta_{500} > 0.750$  occurs more than 20% of the time) the signal-to-noise ratio of the data collection system should be at least 12000:1. For example, if the highest signal output by the least sensitive channel was 500 mV, the collection system would have to measure accurately a signal of 100  $\mu$ V or less (5000:1) or  $\sim 40$   $\mu$ V or less (12000:1). In contrast, the complete system signal-to-noise ratio for irradiance measurements is 10000:1.
- (2) An ability to maintain timing accuracy to better than one second (see Section 2.3.1).
- (3) A time stamp so that  $\partial t$  can be given or calculated.

## 7.4 Calibration

### 7.4.1 General

The calibration of spectral radiometers has yet to be fully resolved. At present there is no hierarchy such as the WRR for spectral radiation. Until such time as a calibration hierarchy becomes available, the BSRN Working Group on Aerosol Optical Depth suggests the following calibration methods:

- (1) An independent detector-based standard. This method uses a fully characterized silicon photodiode trap detector for the measurement of a stable irradiance source that illuminates both the detector to be calibrated and the trap detector simultaneously. This methodology is very successful for calibrating instruments using specific laser wavelengths. The use of this method for the calibration of wider bandwidths remains under development.

- (2) A series of 20 or more 'Langley' type calibrations at a high transmission site over a period of three months or less.
- (3) An absolute calibration of the radiometer using a set of calibrated lamps traceable to a national standards' laboratory.

If more than one spectral radiometer is employed in a network of stations operated by the same agency, the Working Group suggests that a working standard radiometer, calibrated using one of the methods described above, be employed for the calibration of the working spectral radiometers through direct comparison using the ratio-Langley approach. This methodology requires that the instruments being calibrated are identical to the standard instrument. Slight differences in the central wavelength and the passband are acceptable at longer wavelengths, but can increase uncertainty dramatically in regions of absorption bands or at wavelengths where Rayleigh scatter is significant. Ideally, the filters used in the instruments will have been procured at the same time and from the same production batch to ensure spectral matching.

Calibrations should be made annually. On-site methods, for regions with high atmospheric transmittance, can be used to maintain the instrument calibration without removing the instrument from service.

#### 7.4.2 On-site 'Langley' Style Procedures

The measurement of atmospheric transmission is a relative measure, so the absolute top-of-the-atmosphere spectral flux need not be known. The method of Langley calibrations is based on the Bouguer-Lambert-Beer law, which describes the reduction of monochromatic radiation through a medium as a function of the extinction in the medium and the source intensity. For ideal atmospheric conditions this can be expressed as:

$$I(\lambda) = I_0(\lambda)e^{-\tau(\lambda)m}$$

where  $I(\lambda)$  = spectral intensity at the surface  
 $I_0(\lambda)$  = spectral intensity at the top of the atmosphere  
 $\tau$  = optical depth  
 $m$  = the optical airmass

Assuming the passband that represents a wavelength is relatively small so that the assumption of monochromatic radiation is valid, the radiometer output signal ( $V$ ) can be substituted for the intensity, and a radiometer output for the top-of-the-atmosphere ( $V_0$ ) can be determined by extrapolating a series of observations at different airmass values during conditions where the atmospheric turbidity remains constant. Mathematically, this can be easily accomplished through making the equation linear by taking the logarithm of both sides:

$$\ln(V(\lambda)) = \ln(V_0(\lambda)) - m\tau(\lambda)$$

Observations obtained during stable conditions can be analysed using a least-squares regression between airmass and the logarithm of the radiometer output signal. The zero-intercept is the logarithm of the signal that would be observed at the top-of-the-atmosphere.

Although easy to compute, the actual evaluation of  $V_0$  is difficult because the atmosphere is seldom stable over the airmass range needed to obtain the number of observations required to calculate the intercept value. The task becomes more difficult when a large number of  $V_0$  values must be obtained over a short time period.

To overcome this problem, a variety of techniques have been developed, two of which are described following Section 7.4.2.1.

#### 7.4.2.1 Quality Assurance Procedures for Langley Calibration

The acceptance of high values of the coefficient of determination ( $r^2$ ) obtained from a regression analysis has been shown to lead to erroneous values of  $V_0$ . Therefore, several quality assurance procedures can be used to better determine the quality of the intercept.

Forgan<sup>16</sup>, working in mid-latitude sea-level conditions, suggests the following five methods to help determine the quality of the intercept value:

- (1) The sampling period must be as short as possible but provide at least a 3-airmass range between  $2 < m < 6.5$ . Data around solar noon should be avoided.
- (2) If a plot of the residuals of the regression shows a trend in the deviations or any of the residuals are greater than  $\pm 0.006$ , the calculated  $V_0$  is unacceptable.
- (3) If the pressure changes by more than 1 hPa during the period of observations,  $V_0$  for wavelengths less than 500 nm should be discarded, or the molecular scattering normalized to constant pressure using a molecular extinction model.
- (4) The intercept must be less than the intercept calculated for a pure molecular scattering atmosphere.
- (5) The unbiased estimate of the standard deviation of the regression should be less than 0.003

The work of Harrison and Michalsky<sup>17</sup>, besides presenting a means of determining the quality of the Langley regression (see 7.4.2.3), additionally note that:

- (6) The measurement interval should be either in the morning or afternoon and that the data should not be combined.
- (7) Airmass below 2 should not be used, even when available, because the rate of change of the atmosphere is small causing an increased probability of contaminating the data with changing atmospheric conditions.

Finally:

- (8) As the regression is between airmass and signal, the data should be based on airmass observations. Many observation programs are based on time and not airmass. Observations that are equally spaced in time lead to an increased number of measurements at smaller airmass, which in turn produce a bias in the intercept toward these values. This can be overcome by taking measurements at equal airmass or weighting the data as a function of airmass to offset the increase in the number of observations as airmass decreases.

NOTE: The Langley calibration is based on the actual sun-earth distance at the time the calibration is obtained. The use of these calibrations must correct for the change in the sun-earth distance. Commonly, individual Langley calibrations are normalized to the mean sun-earth distance and then converted to the sun-earth distance of the observation as part of the data analyses procedure.

#### 7.4.2.2 Ratio-Langley Technique

The Ratio-Langley technique was developed following the observation that the responsivities of a group of wavelengths obtained over a period of time were found to correlate with each other. This cross-correlation for wavelengths affected by molecules, aerosols and to a lesser extent, ozone (unaffected by strong absorption bands) is expected because of the extinction functions of each of these components. The variation in the cross-correlation comes primarily from the change of aerosol conditions over time,

---

<sup>16</sup> Forgan, B.W., 1986: *Determination of aerosol optical depth at a sea level station - investigations at Gape Grimm BAPS*. CGBAPS Technical Report 5. Gape Grimm BAPS, Gape Grimm, Australia. 55 pages + figures.

<sup>17</sup> Harrison, L, and J. Michalsky, 1994: Objective algorithms for the retrieval of optical depths from ground-based measurements. *Appl. Optics*, 33(22), 5126 - 5132.

which dominates the extinction. Forgan<sup>18</sup> using this observation has developed the ratio-Langley technique to reduce the extrapolation error associated with normal Langley calibrations.

For a wavelength pair  $\lambda_2 < \lambda_1$ , where neither wavelength occurs in a region of strong absorption, and the signals can be given as:

$$I_1(t, \lambda) = I_{01}(\lambda) \exp\left(-\sum \tau_i(t_1, \lambda) m_i(t)\right)$$

and

$$I_2(t, \lambda) = I_{02}(\lambda) \exp\left(-\sum \tau_i(t, \lambda_2) m_i(t)\right)$$

where  $i$  represents the  $i$ th atmospheric attenuator.

The ratio of the two wavelengths can be given as (dropping the wavelength for clarity):

$$I_1(t)/I_2(t) = I_{01}/I_{02} \exp\left(-\sum (t_i(t, l_1) - t_i(t, l_2)) m_i(t)\right)$$

The sum of the optical depth differences is made up of a term combining the constant differences in attenuation due to molecular scattering and gaseous absorption plus the difference due to aerosol attenuation. The latter term is a function of the aerosol optical properties, primarily the size distribution.

Using an Ångström size distribution, it can be shown that the bias error in the ratio of the  $I_0$  pair caused by systematic trends in the AOD can be less than the smallest bias for the individual  $I_0$ . Therefore, the ratio can be used to obtain information on the extraterrestrial constants of the wavelength pair even when the individual extraterrestrial constants are found unacceptable by the removal of atmospheric effects. This can be accomplished in a manner similar to determining the individual extraterrestrial constants by regressing the ratio against airmass.

The ratio results can be utilized successfully for a variety of purposes:

- (1) If a single wavelength is well-calibrated, the ratio method can be used to successfully transfer the calibration information to other wavelengths on the same instrument.
- (2) If well-known extraterrestrial constants are known for a pair of wavelengths, the ratio technique will provide a means of checking the stability of the filters. By combining a variety of filter pairs, those filters with changing responsivity can be determined.
- (3) The transfer of the calibration from one radiometer to a second can be improved through the use of the ratio-Langley technique. The transfer of the extraterrestrial constant from one instrument to another cannot be accomplished using simple procedures, except when the radiometers have identical optics and the centre wavelengths and passbands are perfectly matched. While modern manufacturing techniques used in the construction of commercially available instruments provide the precision necessary to reproduce the optical geometry, the passband and wavelength similarity of interference filters is unlikely. Rearranging the above equation and again removing  $\lambda$  and now  $t$  for clarity, it can be seen that:

$$I_{02} = \frac{I_1/I_2}{I_{01} \exp((\tau_1 - \tau_2) m)}$$

Only if the instruments are identical does the  $\Delta\tau$  term reduce to zero, so that the calibration transfer is no longer airmass dependent.

---

<sup>18</sup> Forgan, B.W., 1988: Sun photometer calibrations by the ratio-Langley method. In *Baselien Atmospheric Program (Australis) 1986*, edited by B.W. Forgan and P.J. Fraser, pp 22 - 26, Bureau of Meteorology, Melbourne, Australia.

### 7.4.2.3 Objective Algorithm

The objective algorithm described by Harrison and Michalsky<sup>5</sup> provides a means to remove observations that may contaminate the Langley calibration method using a quantitative approach. The methodology is used on airmass between 2 and 6 where airmass changes are rapid, but the problem of atmospheric refraction increasing the uncertainty of the analyses is avoided.

The method for direct pointing instruments consists of four steps to remove observations that have been contaminated:

- (1) A forward finite-difference derivative filter is used to remove regions where the slope of the  $dI/dm$  curve is positive indicating atmospheric variability not consistent with uniform airmass-turbidity processes such as cloud contamination. By determining the minimum value of the derivative, the process removes observations for a time period equal to the time between the positive derivative and the minimum derivative on both sides of the minimum.
- (2) A second forward finite-difference derivative filter is then used to determine regions of strong second derivatives. In these regions, if the first derivative is negative and the value greater than twice the mean value of the first derivative for the observations, the regions are eliminated. This method eliminates observations that may have been contaminated by cloud, but missed using Step 1 and those regions where the data has been truncated.
- (3) Perform a least-squares fit to the remaining data. The standard deviation of the residuals about the fit is calculated and all points that have a residual greater than 1.5 times the standard deviation are eliminated. A second least-squares fit is computed on the remaining observations.
- (4) More than  $\frac{1}{3}$  of the original observations must be found valid in this manner and the standard deviation of the residuals about the regression line must be less than 0.006 before the Langley calibration is accepted.

The methods described in Sections 7.4.2.2 and 7.4.2.3 can be combined.

### 7.4.3 Lamp Calibrations

Standard Lamps have not been used generally in calibrating spectral radiometers used in the measurement of AOD. This has arisen because of the lack of high quality top-of-the-atmosphere solar spectral data that existed until recently. As AOD is a relative measure, even a perfectly calibrated system, in absolute terms could not be used to obtain optical depths without a high solar spectrum with uncertainties lower than those needed for the calculation of AOD. Top-of-the-atmosphere spectra are now available that allows for absolute calibrations of spectral radiometers.

Standard lamps have been used successfully for the calibration of absolute spectral intensity. Most national standards' laboratories can provide calibrations of this type at the wavelengths used in standard AOD measurements. Lamp output uncertainty varies by wavelength, with the greater uncertainties in the UV portion of the spectrum. This uncertainty is due to the decreased lamp output in this portion of the spectrum and because small changes in the output current of the voltage source cause large changes in lamp irradiance. A 0.1% variation in current changes the lamp output by 0.9% at 300 nm and by 0.4% at 500 nm.

Standard uncertainties in calibrated-lamp output and transfer uncertainties remain large in comparison with an AOD uncertainty of better than 1%. At 500 nm, the uncertainty associated with a lamp calibrated by the National Institute of Standards and Technology (NIST) of the United States of America is approximately  $\pm 1\%$ . Transfer of this standard to a secondary standard (one used by certified calibration laboratories) in the visible wavelength region is about  $\pm 0.5\%$ . Further uncertainties will be added with the transfer from the secondary standards' laboratory to the calibrated lamp used in the calibration of the radiometer. The increasing uncertainty with multiple transfers suggests that standard lamp calibrations be used only when other means are unavailable.

The use of the same methodology described below, when used with a detector-based standard, provides an instrument calibration based only on the uncertainty associated with the standard detector.

The use of a standard lamp either as a calibration source or as an irradiance source for use with a detector standard, requires precision measurements and optical alignment. A specially designed calibration assembly or an optical bench is essential to obtain a high quality calibration. The following must be taken into consideration:

- (1) The distance between the lamp filament and the first instrument optic must be precisely measured to determine the spectral irradiance at the instrument.
- (2) The source must be far enough from the instrument so that the lamp filament behaves as a point source, rather than a line source.
- (3) This distance between the lamp and the instrument must be great enough to ensure that the FOV of the instrument exceeds the angular field of the lamp (the source must underfill the limiting aperture).
- (4) The instrument must be perpendicular to the beam.
- (5) The combination of the lamp intensity and the integration time used by the detector must be such that the signal is representative of the operating conditions of the instrument. The signal must be significantly greater than the noise level of the detector.

Standard lamps are provided with a calibration certificate indicating the distance at which the spectral irradiance was measured and the current setting used. The distance between the lamp and the radiometer being calibrated can be altered and the inverse square law used to determine the irradiance at the instrument. The current must be maintained to better than 0.01% as changes in current produce nonlinear changes in spectral irradiance.

The calibration certificate of the standard lamp only provides the lamp output at specific wavelengths. Interpolation must be used to determine the lamp output at intermediary wavelengths. Changes in the lamp output with wavelength can be significant, ranging from approximately 4% per nm at 300 nm to less than 0.25% per nm at 750 nm. Interpolation should be done through the fitting of a blackbody curve to the lamp responsivity function.

The calibration of a radiometer using interference filters must consider both the changing lamp output and the transmission function of the filter being calibrated. Thus, the output of the radiometer for a particular filter is the convolution of the lamp's spectral irradiance and the filter function:

$$V_{\lambda_N} = \int_{\lambda_1}^{\lambda_2} E_{\lambda} \cdot Ft_{\lambda} d\lambda$$

where  $V$  = the output voltage of the radiometer at nominal wavelength  $\lambda_N$

$E_{\lambda}$  = the standard lamp irradiance at wavelength  $\lambda$

$Ft_{\lambda}$  = the transmission of the interference filter at  $\lambda$

$\lambda_1, \lambda_2$  = the wavelengths of the filter where the transmission is less than  $10^{-4}$

From the equation above, it can be seen that the calibration of filter radiometers using standard lamps is unlikely to provide uncertainties small enough to calculate AOD to better than 0.01. The use of standard detectors may make this goal achievable.

## 7.5 Maintenance

Daily maintenance procedures for solar pointing spectral radiometers are similar to the care of normal incidence pyrhemeters. The window of the instrument should be cleaned using the same principles found in Section 6.2 (1) (ii). The cleaning should be at a minimum daily and take place after sunrise, and preferably before the solar elevation exceeds  $8^{\circ}$ . The window should also be inspected and cleaned as necessary after precipitation events.

Devices that use diffusers should also be cleaned daily by gently brushing debris from the diffuser material. If the diffuser is extremely dirty, distilled water can be used on most diffusers, but other cleaning chemicals should be avoided. The manufacturer should be consulted on the most appropriate cleaning methods.

The half-angle of spectral radiometers is generally less than half that of pyrheliometers. Therefore, pointing alignment of these instruments must be checked regularly; even if active-tracking is being used. Any changes in the alignment of the optical axes of either the radiometer or the active-tracking sensor can lead to large errors in AOD. Some active-trackers allow for the monitoring of the output of the active sensor, while a few spectral radiometers have quadrant sensors imbedded in the instrument that logs the pointing accuracy. Both of these devices can be used to monitor the quality of the pointing. On systems that combine active-tracking with passive tracking, the system clock should be checked regularly so that the passive mode points correctly also.

## 7.6 Archive Information

Data transmitted to the archive will be in the form of spectral transmission at the wavelengths given in Table 7.1. To calculate AOD from the transmission data, the archive will require information on both the instrument and the atmosphere at the time of the observation. Table 7.2 summarizes the data required by the archive to calculate the AOD from the transmission value, while Table 7.3 outlines the instrument parameters required to understand the measurement.

Parameter	Description	Comment
Date	Date of observation	Date in archive format
Time (t)	Time of measurement in seconds of the day	Numeric value from 1 to 86400
Delta Time ( $\delta t$ )	Period in seconds to collect observation set	To be used in calculations and quality assurance of time
Observed Solar Zenith ( $\theta_t$ )	Observed solar zenith angle in radians	To be used in calculations and quality assurance of time
P(t)	Actual atmospheric pressure (hPa) at time of observation	To be used in calculations. May be submitted separately with other archived data
O <sub>3</sub>	Column ozone amount in atm. cm	To be used in calculations. May be submitted separately with other archived data. Ozone amount is to be representative of ozone overburden at time t
Radiometer Temperature	Numeric in °C	Instrument temperature if thermostatically controlled or available if not controlled. The ambient temperature is sufficient for instruments without temperature control. The latter may be submitted separately with other archived data
Transmission at $\lambda_1$ ( $T_{\lambda_1}$ )	Direct transmission	
Diffuse transmission at $\lambda_1$ ( $D_{\lambda_1}$ )	Diffuse transmission	For cosine style instruments only
<b>Repeat Transmission parameters for each measured wavelength (<math>\lambda_1 \dots \lambda_n</math>)</b>		

Table 7.2. Information that is required by the archive to calculate AOD from transmission data.

Field	Parameter	Description	Explanation
1	Number of Instruments	numeric value of number of instruments supplying data	more than one instrument may be supplying the transmission data
2	Instrument #1 Type	numeric key defining type of instrument	direct pointing (1), cosine derived (2)
3	Instrument Description	Text description of instrument	Manufacturer, model, serial number (if applicable), general information on method of observation, data collection, etc.
4	Detector Type	Text description of the detector	The type of detector (e.g., photodiode, PMT, single, array). The manufacturer and model of detector used (if known). If more than one type of detector is used indicate the detector/wavelength pairing
5	Optics Type	Text description of the instrument optical train.	Description of optics (e.g., single detector with filter wheel; multiple detectors with multiple entrance apertures; focussed system; grating; prism; etc.)
6	Field of View Parameters	Numeric parameters based on type of optics	Information such as opening angle, slope angle, f-number for focussing instruments, directional responsivity for cosine-type instruments, etc.
7	Number of wavelengths	Numeric value of the number of wavelengths	Multiple wavelengths are possible from each instrument
8	Calibration method	Numeric key indicating type of calibration	Langley (1), Instrument comparison (2), standard lamp (3), trap detector (4), combination or other (5)
9	Calibration description	Text description of calibration method	Detailed information on method of calibration
10	Calibration date	Date of calibration. Date to be given in same format as broadband calibrations.	The calibration date given may not be the most recent calibration.
11	Wavelength #1	Actual wavelength ( $\lambda$ )	The measured central wavelength of the passband (e.g., 501.2 nm, not 500 nm)
12	Bandpass #1	Width of first bandpass ( $\delta\lambda$ )	Measured FWHM of bandpass
13	Description of bandpass #1	Text description of bandpass	Information on filter function, blocking filters, slit function etc., depending on type of instrument
14	Calibration uncertainty for wavelength #1	Numeric parameters that describe the uncertainty of the calibration procedure	Include the combined uncertainty of all aspects of the calibration and the confidence level
15	<b>Repeat fields 11 - 14 for each wavelength</b>		
16	<b>Repeat fields 2 - 15 for each instrument</b>		

Table 7.3. Information required by the archive on the instrument(s) being used for determining atmospheric transmission.

## 8.0 Radiometer Calibration

### 8.1 Introduction

Well defined and documented, systematic procedures must be carefully followed to ensure accurate and reproducible instrument responsivities. Calibrations must be routine, internally consistent and traceable if the BSRN is to provide the quality of data required for the calibration and development of satellite algorithms and the measurement of variations in radiation fluxes that may be responsible for climate change.

The responsivity of each solar radiometer must be traceable to the WMO World Radiometric Reference (WRR) which has an estimated accuracy of better than 0.3% and guarantees the homogeneity of radiation measurements to better than 0.1%. This reference is realized by a group of seven absolute cavity radiometers, the World Standard Group, housed at the World Radiation Centre (WRC), Davos, Switzerland. The WSG is externally monitored at each WMO International Pyrheliometer Comparison (IPC) against regional standard cavity radiometers and internally checked during favourable weather conditions throughout the year. Figure 8.1 illustrates the linkage between the solar radiometers associated with a given BSRN observatory and the WRR.

The calibration of broadband infrared radiometers is based upon the Stephan-Boltzmann formula for black-body radiation. While many national meteorological or metrological organizations have the apparatus to perform black-body calibrations, a recent round-robin comparison<sup>19</sup> has indicated that few laboratories are capable of characterizing pyrgeometer response functions well enough to provide responsivities of the quality necessary for the BSRN. More recently, a comparison of infrared irradiance measurements<sup>20</sup> indicated that while the instruments behaved similarly in the field, laboratory calibration differences limited the comparability of measurements to approximately  $\pm 8 \text{ W m}^{-2}$ , while field calibrations reduced this to between 1 - 2  $\text{W m}^{-2}$ . One of the conclusions of the paper was the laboratory calibrations, with few exceptions, remained inadequate.

At each observatory, the station scientist is responsible for the overall maintenance and calibration of each instrument and its associated data acquisition system. Depending upon the instrumentation configuration these procedures may differ slightly, but must maintain the overall standard and frequency of calibration set out within the BSRN documentation.

### 8.2 Pyrheliometer Calibration

#### 8.2.1 Absolute Cavity Radiometer/Pyrheliometer Calibration

To function to the full mandate of the BSRN, each station or network of stations must have a cavity radiometer at each site plus one other cavity radiometer. The on-site instrument (working instrument) will be used to continuously monitor the direct beam radiation, while the second (primary instrument) will maintain the radiometric linkage between the WRR and the instruments at the observatory. Ideally, both instruments should have open apertures. In locations where climate does not permit, the working instrument may have a protective window made of an appropriate material. In such cases, an appropriate correction must be determined for the transmission properties of the window. If the spectral range of the window is less than the solar spectrum at the surface, this correction must account for the humidity regimes of the locale, as the infrared portion of the spectrum will be most affected by the window.

At a minimum of once every two years, the reference instrument must be compared with either the World Standard Group (WSG) of cavity radiometers or with a cavity radiometer which participates regularly at the International Pyrheliometer Comparisons (IPC). Where practical, the former means of reference is preferable. The performance of all reference instruments must be monitored regularly between IPC's

---

<sup>19</sup> Philipona, R. C. Frööh, K. Dehne, J. DeLuisi, J. Augustine, E. Dutton, D. Nelson, B. Forgan, P. Novotny, J. Hickey, S.P. Love, S.B. Bener, B. McArthur, A. Ohmura, J.H. Seymour, J.S. Foot, M. Shiobara, F.P.J. Valero, and A.W. Stawa, 1998: The Baseline Surface Radiation Network pyrgeometer round-robin calibration experiment. *Jour. Atmos. Ocean. Tech.*, 15, 687 - 696.

<sup>20</sup> Philipona, R., E.G. Dutton, T. Stoffel, J. Michalsky, I. Reda, A. Stifter, P. Wendling, N. Wood, S.A. Clough, E.J. Mlawer, G. Anderson, H.E. Revercomb, and T.R. Shippert, 2001: Atmospheric longwave irradiance uncertainty: Pyrgeometers compared to an absolute sky-scanning radiometer, atmospheric emitted radiance interferometer, and radiative transfer model calculations. *J. Geophys. Res.*, 106, D22, 28129 - 28141.

to guard against performance degradation between international comparisons. One means of monitoring performance is the use of the reference instrument in WMO Regional Pyrheliometer Intercomparisons. It should be cautioned that an instrument's calibration coefficients should not be changed unless a confirmed shift in the instrument properties has occurred.

The reference instrument will be used to monitor the responsivity of the field instrument on an ongoing basis depending upon weather. This procedure should occur at least quarterly, if weather permits. While frequent comparisons between the reference instrument and the field instrument are beneficial, it is not the goal of the procedure to compare the instruments at every favourable opportunity. Therefore, it is not necessary for the reference instrument to remain permanently at the station. At sites where a cavity radiometer is being used continuously, normal incidence pyrheliometers should only be used to fill in data gaps when the cavity radiometer is in calibration mode. The output of these thermopile instruments should be correlated with the output of the cavity radiometer obtained immediately before and after the calibration cycle of the field cavity radiometer.

In the special cases where two thermopile pyrheliometers are used to measure the direct beam radiation at a station, only one cavity radiometer is necessary. In this case, the single instrument will follow the procedures set down by the reference instrument in the preceding paragraphs with the exception that the normal incidence pyrheliometers be compared against the reference instrument as frequently as possible. This latter procedure, while more economical, will not provide the same overall quality of data.

In all cases, the link between the WRR and the BSRN observatory instruments should be through a cavity radiometer.

#### 8.2.2 Detailed procedures

As all solar radiation measurements are linked to the output of the working cavity radiometer or working pyrheliometers, great care must be taken to maintain the highest standards in comparing the working instruments with the reference radiometer. This comparison is the prime link between individual BSRN stations and the WRR and thus all other BSRN stations. The following procedures are presented as a means of ensuring that this prime link is maintained with the lowest uncertainty possible.

- (1) The reference and field radiometers should be co-located (within metres). If possible, a permanent mount should be constructed on the same optical axis as the field radiometer for the reference radiometer. If this is not possible, extreme care must be taken to ensure the accuracy of the pointing of both instruments during the comparison.
- (2) To reduce uncertainty, both instruments should be connected to the same data acquisition system. All measurements should be differential. Extreme care must be taken to eliminate unnecessary noise and ground loops. When a single digital multimeter (or equivalent) cannot be used, a reference voltage and reference resistance should be measured by the different multimeters and any discrepancies corrected. The references used should be of the same magnitude as the signals being measured.
- (3) The amplifying frequency should be the same as used during normal operations.
- (4) The averaging period should be a minimum of 10 minutes and a maximum of 25 minutes. Following each averaging period those instruments operated in a passive mode (e.g., Hickey-Frieden) must be zeroed and calibrated. The minimum time allotted for each of these functions should be one minute.
- (5) All calibration activities must be conducted on days in which the cloud cover is less than 4/8's and the cloud is greater than 15° distant from the solar disk. As a quantitative check of stability, all averaging periods must have a standard deviation of less than 0.1% of the mean solar signal during the averaging period or  $0.3 \text{ W m}^{-2}$  (whichever is greater).
- (6) The irradiance levels should be between 400 and 1100  $\text{W m}^{-2}$  during the comparison (the maximum value is dependent upon season, latitude and altitude).

- (7) An averaging period where the difference between the reference instrument and the field instruments is greater than 1%, and is greater than 3 standard deviations away from the mean difference should be discarded.
- (8) A minimum of 25 acceptable series must be completed for each comparison.
- (9) All changes in the ratio between the reference and the field instrument(s) must be recorded. Changes of less than 0.1%/year (normalized) need not be reported to the archive.

Changes greater than 0.5%/year (normalized) indicate significant drift in one or both of the instruments and remedial action should be taken immediately. If a third cavity radiometer is available, the comparison should be repeated in an attempt to isolate the changes. Once the problem instrument is isolated, it should be returned to the manufacturer to identify the cause of the change in responsivity.

- (i) If the field cavity radiometer is faulty, the reference instrument should be used as a replacement until the field instrument is returned. At that time, the reference instrument should be compared against the WRR.
- (ii) If one of the field pyrheliometers is found to be in need of service, another pyrheliometer of the same manufacture and model should be substituted while it is sent for service.
- (iii) If the reference instrument has apparently changed its responsivity, the instrument should be sent to the manufacturer to determine the reason(s) for the change and then compared against the WRR before a new comparison with the field instruments is performed.

The archive should be informed of the problem and its solution once obtained. Large changes of this nature may require re-evaluation of previously obtained data. If expertise is not available to analyse the effects such a change in responsivity may have on previous determinations of the responsivity of other instruments or on the data, contact the BSRN archive for further advice.

### 8.3 Pyranometer Calibration

The standard procedure for the calibration of pyranometers adopted by the BSRN is that of Forgan (1996)<sup>21</sup>. This method recognizes that the best calibration accounts for the climatic regime in which the pyranometer is located. The following steps provide a brief outline of the procedure.

- (1) Two (or four for redundancy) pyranometers are required with approximately equal sensitivity. The original sensitivities can be determined by the sun/shade technique against a standard radiometer.
- (2) One instrument is used as the global instrument, while the second is installed on site as the shaded radiometer. Care must be taken to ensure that the area blocked by the diffuse disk matches the field of view of the cavity radiometer (or working pyrheliometer) being used for the measurement of direct beam radiation.
- (3) At about the time of the summer solstice, the two pyranometers are switched during a period of sunny weather.
- (4) Using a series of simultaneous equations the sensitivity of the two pyranometers can then be calculated from the data obtained during the several days before and after the instrument swap.

This procedure has several significant advantages over the sun/shade method of pyranometer calibration. Firstly, the procedure does not require the instrument to be removed from service during the calibration procedure with the exception of changing its location, which can be accomplished during darkness.

---

<sup>21</sup> Forgan, B. W., 1996: A new method for calibrating reference and field pyranometers, *Journal of Atmospheric and Oceanic Technology*, 13 638 - 645.

Secondly, it alleviates the potential of thermal shock to the instrument which occurs first when the instrument is exposed to direct beam radiation and then again when the instrument is shaded. The actual extent of such shock has not been measured for all instruments, but may be significant. Thirdly, the pair of instruments being used to measure diffuse and global (the redundant measurement) solar radiation are calibrated simultaneously.

A similar transfer method of calibration can also be undertaken during days where there are periods where the solar line of sight is clear and periods where the sun is covered by cloud. By assuming that the disk subtending the angular extent of the sun removes an insignificant amount of diffuse radiation during overcast conditions, the responsivity of the direct beam radiometer can be transferred using a similar set of simultaneous equations of two variables and two unknowns.

By grouping all the data obtained from either of these procedures, the uncertainty due to the instrument directional responsivity (cosine and azimuth error) becomes inherent in the coefficients over the multitudes of samples that make up the calibration procedure. Conversely, by grouping samples with respect to zenith angle and intensity, the cosine response and the linearity of the instrument can also be determined.

In the calibration procedure, care must be taken to eliminate the zero offset components associated with the net thermal radiation of the sensor and its surroundings. ISO 9060 considers a ventilated first class instrument to be one for which this negative flux is less than  $\pm 15 \text{ Wm}^{-2}$  for a net thermal flux of  $200 \text{ Wm}^{-2}$ . This offset becomes important when two instruments have significantly different offsets and when the responsivity is transferred from the pyrheliometer to the shaded radiometer. If care is not taken to eliminate the offset, it will be incorporated into the responsivity as an uncertainty in the calibration slope. At large radiation levels the error is minor, however, in the diffuse flux, it can be lead to as much as a 20% underestimation.

Although the zero offset is observed at night it remains part of the pyranometer signal throughout the daylight hours, especially during clear days. Several methods have been used to estimate the magnitude of the offset, with the general consensus being that the most accurate measurements of solar irradiance are those that correct the the zero offset of individual pyranometers. A methodology, however, has yet to be agreed upon within the BSRN community. Section 9.2.2 outlines two experimental techniques. Individual thermal offset calibration tests should be performed on site and with the instrumentation used for the global and diffuse measurements.

Not all locations, nor all instruments experience nighttime thermal offsets. Black and white thermopile instruments are self-compensating with respect to infrared emissions. Pyranometers that use different transducers for the measurement of solar radiation are also not affected in the same manner.

#### **8.4 Pyrgeometer Calibration**

Absolute calibration of pyrgeometers is difficult because of the complex interaction between the instrument and the incoming signal. This is primarily due to the difficulty in producing an hemispheric interference filter to transmit the broadband infrared signal (approximately 4 - 50  $\mu\text{m}$ ) emitted by the atmosphere and/or earth's surface to the thermopile detector. Two complications to be surmounted through characterization and calibration are: (1) The absorptance of solar radiation by the dome causing heating and thus thermal emissions from the dome to the sensor surface. (2) The variation of transmissivity of the dome over the wavelength range. The first is overcome by monitoring the dome temperature and correcting for the increase in signal reaching the thermopile, while the second requires calibrating the instrument in a thermal radiation regime similar to that in which the instrument is to be deployed.

At present no standard method exists for the calibration of pyrgeometers, but most characterizations are accomplished by applying the Stefan-Boltzmann Law to a blackbody calibration source. Therefore, to reduce the overall uncertainty between measurements made in various countries using different calibration techniques, the BSRN Scientific Panel recommends that the primary calibration of pyrgeometers be performed at the WRC, or other authorized centres, following the procedures developed by Philipona *et al.* (1995). While not yet recognized as an absolute calibration, this procedure reduces measurement uncertainty through the inclusion of varying both the cavity and dome temperatures of the pyrgeometer, as well as varying the radiative temperature of the blackbody. All three temperatures are varied respecting the mean annual temperature of the location of the final deployment of the pyrgeometer. In this manner, each instrument is characterized for a specific radiation regime.

To maintain the traceability of pyrgeometer measurements the following procedure has been established:

- (1) Each BSRN station requires a minimum of two pyrgeometers, initially calibrated at the WRC. One of these instruments is to be declared a site reference instrument and used only during times of comparison. The other instrument(s) will be classified as the field instrument(s). An initial comparison of the two instruments should be made immediately upon deployment at the station to determine the relationships between the thermistors and thermopiles of the instruments.
- (2) Comparisons between instruments should occur a minimum of once every 4 months at sites where no significant seasonal variations occur and once each season (nominally every 3 months) at locations with significant change. IT SHOULD NOT BE NECESSARY FOR THE FIELD INSTRUMENTS TO BE TAKEN OUT OF SERVICE DURING THE PERIOD OF THE COMPARISON.
- (3) Wherever possible, the instruments being compared should use the same tracking shade device and data acquisition system to reduce systematic biases. Instrument ventilation must be with the same style ventilator. In cases where separate tracking shade devices are used, care must be taken to ensure that both the field and reference instruments are shaded correctly. When the same data acquisition system cannot be used, a comparison between data acquisition systems must be performed. Comparison data should not be collected until the reference instrument has come to thermal equilibrium with its surroundings.
- (4) Normal station sampling protocols should be used during the comparison.
- (5) The comparison should last a minimum of 2 days and a maximum of 5 days. It is desirable that data be obtained which corresponds to a typical range of irradiances for the period. This may be accomplished by acquiring measurements under a variety of non-precipitating weather conditions during both daylight and nighttime hours.
- (6) From the continuous data set collected during the comparison period, only steady-state conditions should be used for the comparison. This can be somewhat arbitrarily defined as those periods where the standard deviations of the thermopile and thermistor signals are less than 0.25% of the magnitude of the respective mean signal for the averaging period.
- (7) Analyses should be performed to determine if there are any changes in the following:
  - (i) the ratio of a given reference instrument thermistor to the respective field instrument thermistor (dome and body).
  - (ii) the ratio of the reference instrument thermopile output to the field instrument thermopile output.
  - (iii) the ratio of the calculated irradiance of the reference instrument to the calculated irradiance from the the field instrument.

Note: For typical irradiances, the temperature of the case accounts for between 75 and 100% of the signal for clear to isothermal conditions. The Eppley PIR uses Yellow Springs Instruments (YSI) thermistor YSI 44031 for these measurements. The thermistor is specified to have an interchangeability of  $\pm 0.1$  °C between 0 °C and 70 °C and is nominally 10 K $\Omega$  at 25 °C. Conversion from resistance to temperature is accomplished through the Steinhart and Hart equation,

$$T^{-1} = a + b(\ln R) + c(\ln R)^3$$

where      T = temperature in Kelvin  
              R = resistance in ohms

The coefficients for the YSI 44031 thermistor are: a = 0.0010295, b = 0.0002391 and c = 1.568e-07.

Using these values, the difference between the measured temperature at a given resistance and the calculation at that resistance is no more than 0.02 °C through the temperature range -60 °C to 50 °C. Figure 8.1 illustrates the effect of a positive deviation in the determination of the case temperature on the calculated 'case flux' from the correct value. This difference may be due to sampling errors, an incorrect thermistor reading (e.g. the case thermistor is not representing the actual cold junction temperature) or an incorrect thermistor inversion equation. As can be seen, unless the error is greater than approximately 5%, the overall accuracy of the measurement is not greatly affected.

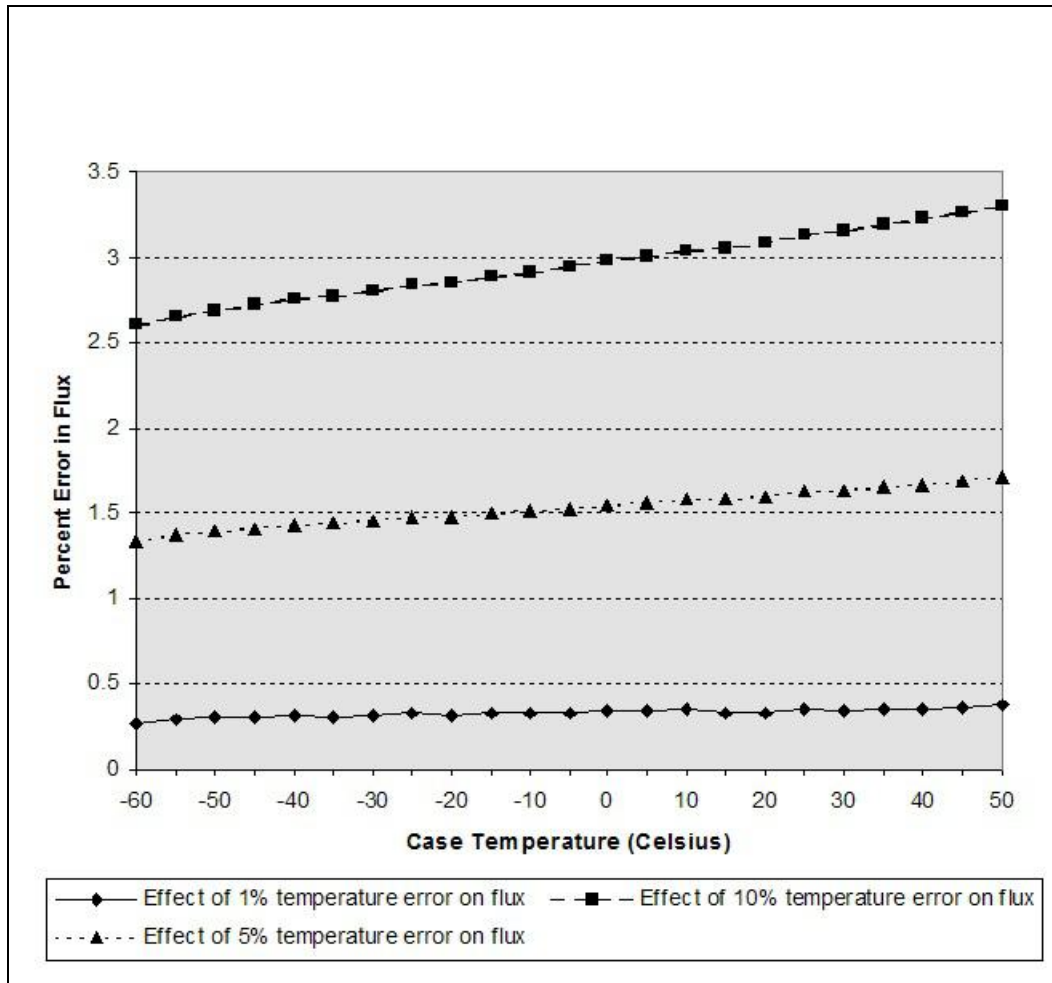

Figure 8.1. Percentage change in infrared flux due to case thermistor errors.

## 9.0 Radiation Data Reduction and Quality Assurance Procedures

### 9.1 Introduction

To be certain that the quality of the data obtained is of a high standard, care must be taken from the initial site set-up through the selection of the instrumentation and DAS to the daily maintenance of the radiometers. Once a voltage or resistance measurement is taken, nothing can be done to improve the quality of that measurement. Nevertheless, if quality assessment is done in near-real-time, any inaccuracies found in the process can be corrected so that future data are of a higher quality. This section will suggest a number of operations that can be performed on the data to aid in the rapid assessment of the measurements.

Although the BSRN Archive has carefully laid out the format required for the measurements to be included in the archive, it is recommended that all measurements be kept in their original form (e.g., voltage, resistance, counts etc.), either at the network observatory or the parent institution. Maintaining these data eliminates the need for any back processing of engineering data when new, improved or corrected algorithms need to be applied. Furthermore, unless the instrument can be shown to be malfunctioning or disconnected, data should not be removed from the data stream, but only flagged because of unlikely values. The use of the daily log report of activities associated with the station is crucial when considering the removal of data.

### 9.2 Standard Data Reduction Procedures

Local quality assurance procedures provide a means of assuring that the data are internally consistent (to some level of uncertainty) within the site. However, to ensure consistency throughout the network, more is required than simply providing calibration traceability; the actual means of reducing the transducer signals to engineering units must have common outcomes. Within the BSRN instruments made by a variety of companies are being used in an attempt to measure the same radiative and meteorological variables. The results of these measurements can only be compared if the differences are known not to come from the algorithms chosen by individual station managers in the conversion of transducer signals to engineering units. In an attempt to overcome this increased uncertainty, the following section sets out protocols to be followed in the data reduction process.

#### 9.2.1 Cavity Radiometer and Pyrheliometer

The reduction of all data from cavity radiometers should be fully compatible with the WRC procedures used in the calculation of the WRR and the conversion of electrical signals to irradiance values used during International Radiation Comparisons and published by the WRC<sup>22</sup>.

For pyrheliometer signals, the conversion should be based upon the assigned responsivity determined through comparison with a cavity radiometer following the subtraction of any zero signal. The responsivity of the instrument should be normalized to the temperature at which the calibration was obtained if the change in responsivity over the temperature range of the instrument changes by greater than a 0.5%. The irradiance would then be calculated as:

$$F = R_T \cdot T(K) \cdot (V - V_z)$$

where F	=	the irradiance in W m <sup>-2</sup>
R <sub>T</sub>	=	the instrument's responsivity at temperature T in μV W <sup>-1</sup> m <sup>2</sup>
T(K)	=	the ratio of the responsivity of the instrument at temperature K to that at the calibration temperature T
V	=	the signal in mv under irradiance
V <sub>z</sub>	=	the zero offset voltage.

#### 9.2.2 Pyranometers

Pyranometer signals should be corrected for zero offset before the responsivity factor is applied to the transducer signal. In the same manner as the pyrheliometer, if the responsivity of the instrument

---

<sup>22</sup> For example: International Pyrheliometer Comparisons IPC VII, 24 September to 12 October 1990, Results and Symposium. Working Report No. 162, Swiss Meteorological Institute, Davos and Zurich, March 1991, 91 pages.

changes by greater than 0.5% over the operating temperature range of the instrument, a responsivity correction factor should be applied.

The zero-offset due to thermal emittance should be corrected, but presently no agreement on the correction methodology has been reached. Two common methods are presented below:

- (1) An empirical correction factor dependent on instrument type can be used of the form<sup>23</sup>:

$$os = b_0 + b_1 \text{NetIR} + b_2 \text{DC}$$

where: os = offset in  $W\ m^{-2}$   
 NetIR = the net IR irradiance measured by the thermopile of a shaded and ventilated pyrgometer  
 DC =  $\sigma [T_{\text{dome}}^4 - T_{\text{case}}^4]$   
 T = measured pyrgometer temperatures  
 $\sigma$  = Stefan-Boltzmann constant  
 $b_x$  = regression coefficients dependent on instrument

- (2) A similar correction using the IR irradiance has been used with several instruments when they are mounted in the Canadian Meteorological Service ventilated housing: This methodology correlates night time offset with the incoming infrared radiation. The relationship for Eppley PSP's and Kipp and Zonen CM11's is approximately<sup>24</sup>:

$$Z = -1.5 + 0.025 P$$

where: Z = the zero offset  
 P = the infrared signal as measured by the pyrgometer

As both of these methods are determined empirically on a limited number of instruments, the coefficients should not be applied without first testing the results on the individual instruments on which they are to be used.

A less accurate method of determining the offset, is through the linear interpolation of the 60-minute-mean value of the pyranometer signal from before and after astronomical twilight ( $\geq 108^\circ$ ) for the same day. This assumes that the infrared response of the instrument remains reasonably constant throughout the solar day, which is not the case in conditions of scattered cloud.

### 9.2.3 Pyrgometers

The pyrgometer signal should be based upon the calibration constants directly traceable to the WRC blackbody. The flux should be calculated as<sup>25</sup>:

$$E = \frac{U_{emf}}{C} (1 + k_1 \sigma T_B^3) + k_2 \sigma T_B^4 - k_3 \sigma (T_D^4 - T_B^4) - f \Delta T_{S-N}$$

where C = thermopile responsivity ( $\mu V\ W^{-1}\ m^2$ )

$k_i$  = instrument dependent calibration constants

<sup>23</sup> Dutton, E.G., J.J. Michalsky, T. Stoffel, B.W. Forgan, J. Hickey, D. W. Nelson, T.L. Alberta and I. Reda, 2001: Measurement of broadband diffuse solar irradiance using current commercial instrumentation with a correction for thermal offset errors. *Jour. Atmos. Ocean. Tech.*, 18, 297 - 314.

<sup>24</sup> Wardle, D.I. et al., 1996: *Improved measurements of solar irradiance by means of detailed pyranometer characterisation*. Solar Heating and Cooling Programme Task 9, International Energy Agency Report IEA-SHCP-9C2, Atmospheric Environment Service, Downsview, Ontario.

<sup>25</sup> Philipona, R. C. Fröhlich, Ch. Betz, 1995: Characterization of pyrgometers and the accuracy of atmospheric long-wave radiation instruments. *Applied Optics*, 34(9) 1598-1605.

$T_B$	=	pyrgeometer body temperature (K)
$T_D$	=	pyrgeometer dome temperature (K)
$U_{emf}$	=	the electrical output from the thermopile
$f\Delta T_{S-N}$	=	a correction factor for infrared irradiance on unshaded domes. Details are given in Philipona <i>et al.</i> (1995).

The thermistor temperatures are calculated using the Steinhart and Hart equation with the standard coefficients provided by the manufacturer:

$$T^{-1} = a + b(\ln R) + c(\ln R)^3$$

where	T	=	temperature (K)
	a,b,c	=	the standard coefficients provided by the manufacturer
	R	=	the resistance in ohms.

Newer pyrgeometers are now being tested, but have not yet become common in the BSRN network. The equations provided by the manufacturer of these instruments should be applied to obtain the infrared flux.

### 9.3 Quality Assurance Techniques

#### 9.3.1 General testing procedures

##### 9.3.1.1 Redundancy

Having more than one instrument measure the same signal is useful. This provides a means of flagging a signal as problematic when the redundant measurements differ and gives backup observations during times when routine maintenance is being done or an instrument is malfunctioning. It is recognized that having multiple instruments is not always feasible and this is therefore not mandated within the BSRN framework.

##### 9.3.1.2 Visual inspection

The most rapid means of determining gross problems with the incoming data are visual. It is highly recommended that the DAS provide near-real-time (minutes) graphical displays of the data, whether converted to engineering units or simply transducer signals. A preliminary conversion provides the technician a better appreciation for the data, but large changes such as infinite resistance or zero signal can be determined easily even from transducer signals. While the data being stored at a one minute interval provide significant information for later quality assurance testing, the initial displays need only be the mean values. The more frequent the processed signal is output, the better chance the observer has of observing unusual phenomena.

On clear days, rapid sampling of the data can provide a graphical means of ascertaining whether individual instruments are level, or if any biases are in the solar-tracking instruments being used. Such changes will be obvious through the asymmetry of the data.

Grouping of incoming values is also beneficial. For example, placing the temperature signals of all of the pyranometers on one graphical display provides a rapid means of determining if one instrument (or its ventilator) is malfunctioning by showing large temperature departures from the other instruments.

##### 9.3.1.3 Limit Checking

Automatic limit checks can be programmed into many DAS's. These limits can be such that flags are automatically inserted into the data stream to warn the operator of potential problems. A key example is the use of limits to test the resistance of instruments frequently (hourly, daily) and provide a warning if the resistance is above or below a normal set of limits. Resistance limits of this type can also be effectively set out with respect to thermistor measurements.

Similar checks can be set up with respect to voltage signals. If instruments have known ranges, limits can be set to warn the operator if the instruments exceed the range. Two types of ranges must be

considered in these cases. The first is the normal range of the instrument, for example a pyranometer range may be -0.1 to 12 mV, while the second is the absolute range such as 0 - 5 V for a pressure transducer. In setting bounds checks on the former, one can simply be observing an unusual phenomenon, while on the latter, if the limit is exceeded, an instrument problem has occurred.

#### 9.3.1.4 Conversion to solar time

While visually inspecting the data while it is being archived in local standard or UTC is useful, converting the data, either in real time or post-processing, provides an excellent means of determining accuracy of the system time. For systems recording data with a frequency of one-minute or greater, the symmetry around solar noon (clear or partly clear days) can provide a means of independently checking the system time. Corrections to the time can be made by adjusting the time stamp on the data to restore the curve's symmetry. Care must be taken in correcting data in this manner and a timing flag should be set to allow future users to know a time shift has occurred. Once noted, correction of the problem should be undertaken as rapidly as possible.

#### 9.3.1.5 Scanning Minimum, Maximum, Standard Deviations

While difficult to accomplish in real time, post-processing scans or plots of the min, max, and standard deviations of the signals should be done both on individual channels and on multiple common channels to check for any short term uncertainties that have not been noticed using only the mean values. Minimum values dipping below zero or maximums exceeding reasonable values, particularly in comparison with other similar signals, provide a rapid way of focussing on potential problems. A simple example would be the cleaning of the dome of an instrument during cloudy bright conditions. Although the mean value of one minute may not be significantly altered, the minimum value and the standard deviation could be altered profoundly. In this manner, single data points could be flagged for times of increased uncertainty.

During any period, if several peculiar events occur, the frequency and periodicity of the events should be tested. Such periodic problems could indicate potential electronic failures, buffering problems in the transfer of data or difficulties associated with the DAS.

#### 9.3.2 Procedures for specific fluxes

##### 9.3.2.1 Direct, diffuse and global

Testing the direct and diffuse against the global radiation is a simple and straightforward test, with the exception of time near sunrise and sunset, and to a lesser extent during times of rapidly changing irradiance levels (because of different instrument response times). This test should be done on all irradiance data before submitting the data to the archive. Simply,

$$GLOBAL = DIFFUSE + DIRECT \cos(\theta)$$

where the zenith angle ( $\theta$ ) must be calculated according to the station location, date and time (Annex I provides an algorithm)

During clear sky or stable conditions, the difference between the global and the summation should be within the uncertainty levels given to the instruments. In the case of a cavity radiometer and two well-calibrated pyranometers the differences should be less than 2% or 15 W m<sup>-2</sup>, whichever is less, at solar elevations greater than 10°. At lower solar elevations and during changing conditions, the differences should be less than 3.5% or 20 W m<sup>-2</sup>, whichever is less. For larger differences further tests should be done to determine the cause of the discrepancy.

NOTE: If the direct and shaded radiometers are on the same platform care must be taken when using this procedure. During times when the solar tracking is slightly misaligned, the errors in the direct beam and the diffuse can be offsetting within the range of the uncertainty values given above.

### 9.3.2.2 Downwelling infrared radiation

The downwelling infrared signal should be compared against the effective infrared irradiance derived from the air temperature at the same location:

$$L_{eff} = \sigma T_a^4$$

where  $L_{eff}$  = effective radiation signal in  $Wm^{-2}$   
 $\sigma$  = Stefan-Boltzmann constant  
 $T_a$  = air temperature (K)

With the exceptions of isothermal fog and strong inversions over cold surfaces, the effective irradiance should be greater than that measured by the pyrgeometer. In fog, the two values should be nearly equal.

Including a surface emissivity term of 0.75, provides a reasonable lower bound against which the instrument radiation should be consistently greater.

In both cases these values should be used conservatively for flagging suspect data and determining whether problems exist with the instrument components. Data should only be flagged if, upon examination, an instrument defect is discovered.

## 9.4 Data Submission to the BSRN Archive

Data, once quality assured by the site scientist, are to be submitted to the BSRN archive at the Swiss Federal Institute of Technology (ETH) in Zurich, Switzerland. Full documentation on the BSRN database is found in: *Technical Plan for BSRN Data Management, World Radiation Monitoring Centre (WRMC) Technical Report 1, Version 2.1*<sup>26</sup>. A brief summary of this and other information concerning access to the database can be found on the internet at [bsrn.ethz.ch/wrwc/database\\_internal.html](http://bsrn.ethz.ch/wrwc/database_internal.html). Annex Q provides information on the linkages between the data acquisition at the BSRN station and the WRMC, ETH.

Data submission requires that the format set out in the above manual be adhered to strictly. To support this effort, WRMC has developed a program, F\_CHECK.C that performs checks on line length, illegal characters and line format. This program can be obtained directly from the archive and should be requested when the necessary access permissions are established (data manager email: [bsrnadm@geo.umnw.ethz.ch](mailto:bsrnadm@geo.umnw.ethz.ch)).

The procedure for submitting data to the archive begins with obtaining an account on a secure FTP server for which only the station scientist (or named designates) has access. This is accomplished by informing the database administrator of the intent to submit data and providing the FTP addresses of one or two machines from which the data will be submitted. In response the archive will set up a secure directory on their server and provide the requestor account information and a password. These will only function from the machines with the submitted FTP addresses. Following logon, the system will place the user directly into the directory in which to submit the data files for the station.

Upon receipt of the data files (monthly blocks in sequential order are preferred) at the archive, the data are automatically moved from the input directory into a second directory from where they are automatically checked for formatting problems etc. If errors in the data are found, an error log is produced and returned to an error directory associated with the station name. This error log can then be downloaded and the incorrectly formatted data files deleted from the BSRN server. Once corrected the data are resubmitted. It is suggested that the first block of data submitted to the archive be only one month because of the usual problems associated with correctly formatting the data files.

---

<sup>26</sup> Gilgen, H. *et al*: Technical Plan for BSRN Data Management, World Radiation Monitoring Centre (WRMC) Technical Report 1, Version 2.1. *World Climate Research Programme WMO/TD-No. 443*. 1995

## **Annex A Site Description Documentation**

Templates for use with the site description documentation that is found in Section 3.2.

# ***BSRN STATION DESCRIPTION***

***STATION MANAGER***

***STATION LOCATION***

***TOPOGRAPHIC MAP OF SURROUNDING 15 KM RADIUS***

***1***

# ***BSRN SITE DESCRIPTION***

***SITE DESCRIPTION***

***CLIMATE***

***DESCRIPTIVE MAP OF SURROUNDING 2 KM RADIUS***

**2**

# ***BSRN SITE DESCRIPTION***

***INSTRUMENT DESCRIPTION***

***INSTRUMENT LOCATION MAP***

***HORIZON MAP OF CENTRAL  
INSTRUMENT***

***DESCRIPTION OF METEOROLOGICAL INSTRUMENTS***

**3**

# ***BSRN STATION VIEWS***

*VIEW 1*

*DESCRIPTION*

*VIEW 2*

*DESCRIPTION*

# ***BSRN STATION VIEWS***

*VIEW 3*

*DESCRIPTION*

*VIEW 4*

*DESCRIPTION*

## **A.1 Example of Site Description Documentation**

The following pages provide sample pages of the Site Description Documentation for the Bratt's Lake Observatory. The regional and local maps of the area, the instrument field of view surveys, and the documentation concerning the site location, operator, contacts etc. are mandatory. The general description of the site provides the data user information to assess ground cover, how the instrumentation is installed, the methods used in calibration or if any special observational programs may be operational at the location that are not part of the BSRN program or not included in the archived data. The photographs can aid the user in understanding the type of land cover, general topography and how the instrumentation is installed.

# BSRN STATION DESCRIPTION

## STATION MANAGER



David Halliwell, Site Scientist

## STATION LOCATION

Latitude: 050 12 15 North  
 Longitude: 104 42 46.6 West  
 Elevation: 578 metres ASL

Wilcox, Saskatchewan

Land Location: 14 20 NW 29  
 Approximately 18 km south of Regina  
 7 km west of Highway 6

## TOPOGRAPHIC MAP OF SURROUNDING 15 KM RADIUS

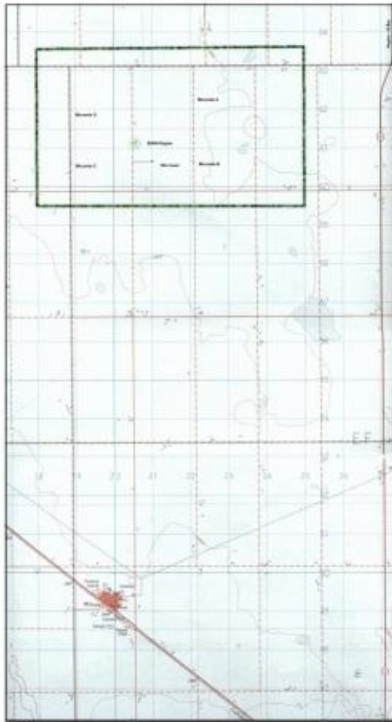

\* ROULEAU  
 SASKATCHEWAN  
 WEST OF REGINA SHEET OF THE 1:50,000 SERIES  
 Scale 1:50,000. Edition 1978



\*\* While visible from the site, the Dirt Hills represent an incline of  $< 0.001$  degrees and present no obstruction to instrumentation

\* National Topographic Survey Map 72 - 1/2 Edition 3  
 1978 Published 1980

\*\* Saskatchewan Grid Map  
 MapArt Publishing

# BSRN SITE DESCRIPTION

## SITE DESCRIPTION

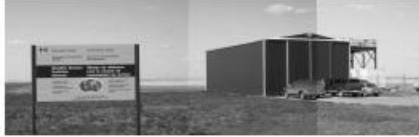

Located in the flatlands, this site spans 16 square kilometers with an average elevation gain of less than 2 metres.

Ground cover varies from bare (fallow) soil to grass and crops. Crops include wheat, flax, and barley.

## CLIMATE

### Subhumid Continental

Categorised as Mixed Moist Grassland, this ecoregion is characterised by mean annual temperatures of 2.4 C, with the July mean reaching 18.4 C and the January mean dropping to -16.7 C. Average annual precipitation in this region measures 383 mm, 240 mm of which falls as rain between May and September. \*

## DESCRIPTIVE MAP OF SURROUNDING 2 KM RADIUS

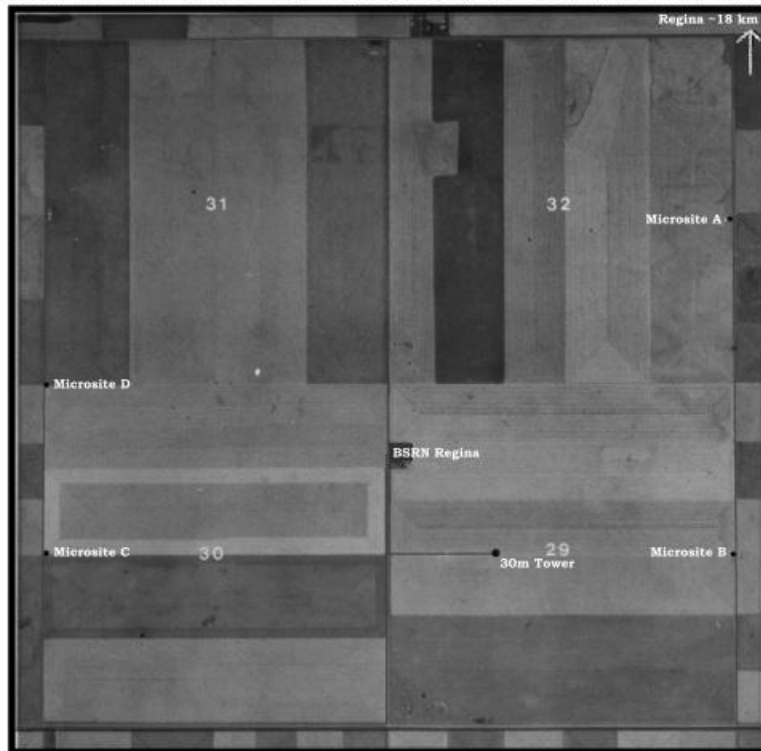

\* From: The Ecoregions of Saskatchewan.  
Canadian Plains Research Centre/Saskatchewan  
Environment and Resource Management. Hignell  
Printing Ltd. 1998:143.

# BSRN SITE DESCRIPTION

## INSTRUMENT DESCRIPTION

1. Global West Kipp and Zonen CM21 Pyranometer
2. Eppley PSP with Red Schott Glass filter
3. Eppley PSP with Green Schott Glass filter
4. Yankee Ultraviolet Biometer
5. Global East Kipp and Zonen CM21 Pyranometer
6. Solar Light Ultraviolet Biometer
7. Brewer Mk III Spectrophotometer (#111)
8. Brewer Mk IV Spectrophotometer (#71)
9. South Tracker - Kipp and Zonen CM21 pyranometer  
Eppley Precision Infrared Radiometer  
Kipp and Zonen CH1 pyrliometer
10. North Tracker - Kipp and Zonen CM21 pyranometer  
Eppley Precision Infrared Radiometer  
Kipp and Zonen CH1 pyrliometer  
Eppley H-F absolute cavity radiometer
11. AREOCAN - Cimel Sunphotometer  
Vitel satellite transmitter
12. USDA UV Network - Yankee MFRSR (visible)  
Solar light Ultraviolet Biometer  
Yankee UV erythmal radiometer  
Yankee MFRSR (UV)
13. Middleton SP01A sunphotometers

## INSTRUMENT LOCATION MAP

Instrumentation: Main Platform

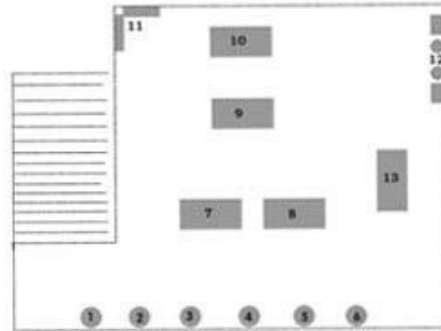

## HORIZON MAP OF CENTRAL INSTRUMENT



N. Az 360 Inclination 0



W. Az 270 Inclination 0



S. Az 180 Inclination 0



E. Az 90 Inclination 0



SE. Az 150 Inclination -3

## DESCRIPTION OF METEOROLOGICAL INSTRUMENTS



-- Global Radiation  
Erythemal Broadband



-- Green PAR\* -- Red PAR -- Global Radiation



Hickey-Freiden

-- Direct Solar Radiation



-- Shaded Longwave

-- Shaded Global



\* Photosynthetically Active Radiation

3

# **BSRN STATION VIEWS**

Platform

*VIEW 1*



## *DESCRIPTION*

**Eastern View**  
**Azimuth 90 degrees**  
**Inclination 0 degrees**  
**(no obstructions)**

*VIEW 2*



## *DESCRIPTION*

**Tower View**  
**Azimuth 150 degrees**  
**Inclination ~3 degrees**  
**(no obstructions)**

4

# **BSRN STATION VIEWS**

Platform

**VIEW 3**



## **DESCRIPTION**

**Southern View**  
**Azimuth 180 degrees**  
**Inclination 0 degrees**  
**(no obstructions)**

**VIEW 4**



## **DESCRIPTION**

**Western View**  
**Azimuth 270 degrees**  
**Inclination 0 degrees**  
**(no obstructions)**

**5**

# **BSRN STATION VIEWS** Platform

**VIEW 5**



## **DESCRIPTION**

**Northern View  
Azimuth 360 degrees  
Inclination 0 degrees  
(no obstructions)**

Additional observation programs:

Canadian Air and Precipitation Chemistry Monitoring Network (CAPMoN): Dry and wet air chemistry  
Particulate measurements (PM 2.5, PM 10)  
Particulate sampling for air chemistry  
Surface ozone

Canadian Brewer Network: UV and columnar ozone

Canadian Ozonesonde Network: weekly ozonesonde flights

Canadian Mercury Deposition Network: observation of gaseous mercury

Health Canada: radioisotope monitoring

USDA UV Network: UV and Visible MFRSR observations

AEROCAN: part of NASA AERONET sunphotometer network

GAW PFR Network: sunphotometer network

Full meteorological measurements, including 10 m and 30 m observations of wind speed and direction, temperature and humidity

## **Annex B Selected Instrumentation**

### **B 1. Instrument Specifications**

#### **B 1.1 Introduction**

The information found in this annex is based upon the use of particular instruments within the BSRN network. When used following the instructions given within the manual, it is believed that these instruments can meet the accuracy requirements specified by the BSRN. Other instrumentation may meet these accuracies but have not been used within the program at the time of publication of this manual.

The instrument specifications provided are those of the manufacturers. Independent tests of the instruments have been made by a variety of laboratories and have been published in the open literature and through technical agencies such as the International Energy Agency. For further information on any of these instruments the reader is advised to contact either a WMO Regional Radiation Centre or the manufacturer directly.

The purpose in providing these specifications is to enable both data users and site scientists to gain information about particular instrument configurations. For the former, this should aid in gaining a better understanding of the data measured by particular instruments; both strengths and weaknesses. For the latter, the choice of an instrument for a particular site can be better determined by knowing what others use in similar situations. Furthermore, by understanding the differences between instruments, questions concerning differences in data quality can be addressed.

The instruments are given in alphabetical order with the specifications provided by the manufacturers. Where possible, specifications common to each manufacturer are used. However, like most manufactured goods, no standard methods of specifying all of the various attributes of an instrument have been adopted. The International Standards Organization (ISO) (ISO 9060, Solar Energy - Specification and classification of instruments for measuring hemispherical solar and direct solar radiation) and the WMO (WMO No. 8, Commission on Instruments and Methods of Observation (CI MO) Guide to Instruments and Methods of Observation) has recommended some guidelines, but these have yet to be universally accepted. Tables B1 and B2 on pyranometer specifications and pyr heliometer specifications found in the ISO document are provided below as a general guide on instrument quality.

<b>Pyranometer Specification List</b>			
Specification	Class of Pyranometer <sup>27</sup>		
	Secondary Standard	First Class	Second Class
Response time: time for 95% response	< 15 s	< 30 s	< 60 s
Zero off-set: (a) Response to 200 Wm <sup>-2</sup> net thermal radiation (ventilated)	+ 7 Wm <sup>-2</sup>	+ 15 Wm <sup>-2</sup>	+30 Wm <sup>-2</sup>
(b) response to 5 K h <sup>-1</sup> change in ambient temperature	± 2 Wm <sup>-2</sup>	± 4 Wm <sup>-2</sup>	± 8 Wm <sup>-2</sup>
Resolution (smallest detectable change)	± 1 Wm <sup>-2</sup>	± 5 Wm <sup>-2</sup>	± 10 Wm <sup>-2</sup>
Stability: percentage change in responsivity per year	± 0.8 %	± 1.8 %	± 3 %
Non-linearity: percentage deviation from the responsivity at 500 Wm <sup>-2</sup> due to change in irradiance within 100 Wm <sup>-2</sup> to 1000 Wm <sup>-2</sup>	± 0.5 %	± 1 %	± 3 %
Directional response for beam radiation (the range of errors caused by assuming that the normal incidence responsivity is valid for all directions when measuring, from any direction, a beam radiation whose normal incidence irradiance is 1000 Wm <sup>-2</sup> )	± 10 Wm <sup>-2</sup>	± 20 Wm <sup>-2</sup>	± 30 Wm <sup>-2</sup>
Spectral selectivity: percentage deviation of the product of the spectral absorptance and the spectral transmittance from the corresponding mean within 0.3 µm and 3.0 µm	± 2 %	± 5 %	± 10 %
Temperature response: total percentage deviation due to change in ambient temperature within in interval of 50 K	2 %	4 %	8 %
Tilt response: percentage deviation form the responsivity at 0° tilt (horizontal) due to change in tilt from 0° to 90° at 1000 Wm <sup>-2</sup> irradiance	± 0.5 %	± 2 %	± 5 %

Table B 1.1. Pyranometer specification list from ISO 9060.

<sup>27</sup> Pyranometers, pyrhemometers and pyrradiometers have been categorized into three groupings depending upon the quality of the instrument. The instrument must meet all the specifications of a given category before being classified within the category. The highest category for pyranometers is the secondary standard because the most accurate determination of global irradiance is believed to be the sum of the direct beam irradiance as measured by an absolute cavity radiometer and the diffuse solar irradiance as measured by a secondary standard pyranometer shaded from the sun by a disc.

Pyrheliometer Specification List			
Specification	Class of Pyrheliometer		
	Secondary Standard	First Class	Second Class
Response time: time for 95% response	< 15 s	< 20 s	< 30 s
Zero off-set: response to 5 K h <sup>-1</sup> change in ambient temperature	± 2 Wm <sup>-2</sup>	± 4 Wm <sup>-2</sup>	± 8 Wm <sup>-2</sup>
Resolution (smallest detectable change in Wm <sup>-2</sup> )	± 0.5 Wm <sup>-2</sup>	± 1 Wm <sup>-2</sup>	± 5 Wm <sup>-2</sup>
Stability (percentage of full scale, change/year)	± 0.5 %	± 1 %	± 2 %
Non-linearity: percentage deviation from the responsivity at 500 Wm <sup>-2</sup> due to change in irradiance within 100 Wm <sup>-2</sup> to 1000 Wm <sup>-2</sup>	± 0.2 %	± 0.5 %	± 2 %
Spectral selectivity: percentage deviation of the product of the spectral absorptance and the spectral transmittance from the corresponding mean within 0.3 µm and 3.0 µm	± 0.5 %	± 1 %	± 5 %
Temperature response: total percentage deviation due to change in ambient temperature within in interval of 50 K	± 1 %	± 2 %	± 10 %
Tilt response: percentage deviation form the responsivity at 0° tilt (horizontal) due to change in tilt from 0° to 90° at 1000 Wm <sup>-2</sup> irradiance	± 0.2 %	± 0.5 %	± 2 %
Traceability: maintained by periodic comparison	with a primary standard pyrheliometer	with a secondary standard pyrheliometer	with a first class pyrheliometer or better

Table B 1.2. Pyrheliometer specification table from ISO 9060.

## B 2. Pyranometers

### B 2.1 Eppley Laboratory Model PSP Pyranometer

The Precision Spectral Pyranometer is designed for the measurement of sun and sky radiation totally or in defined broad wavelength bands. It comprises a circular multi-junction wire-wound Eppley thermopile. The thermopile has the ability to withstand severe mechanical vibration and shock. Its receiver is coated with Parson's black lacquer (non-wavelength selective absorption). This instrument is supplied with a pair of removable precision ground and polished hemispheres of Schott optical glass. Both hemispheres are made of clear WG295 glass which is uniformly transparent to energy between 0.285 to 2.8  $\mu\text{m}$ . Other Schott coloured glass outer hemispheres include clear (GG395), yellow (GG495), orange (OG530), red (RG630), and dark red (RG695). For special applications, other Schott glasses and Infrasil II quartz hemispheres are available.

Included is a spirit level, adjustable levelling screws and a desiccator which can be readily inspected. The instrument has a cast bronze body with a white enamelled guard disk and comes with a transit/storage case.

A calibration certificate traceable to the World Radiation Reference and a temperature compensation curve is included.

#### Specifications

Sensitivity:	approx. $9 \mu\text{V W}^{-1}\text{m}^2$
Impedance:	approx. $650 \Omega$
Temperature Dependence:	$\pm 1\%$ over ambient temperature range $-20$ to $+40^\circ\text{C}$ temperature compensation of sensitivity (can be supplied over other ranges at additional charge)
Linearity:	$\pm 0.5\%$ from 0 to $2800 \text{ Wm}^{-2}$
Response time:	1 second (1/e signal)
Cosine:	$\pm 1\%$ from normalization $0-70^\circ$ zenith angle; $\pm 3\%$ $70-80^\circ$ zenith angle
Mechanical Vibration:	tested up to 20 g's without damage
Calibration:	integrating hemisphere
Size:	5.75 inch diameter, 3.75 inches high
Weight:	7 pounds
Orientation:	Performance is not affected by orientation or tilt

### B 2.2 Kipp & Zonen Delft BV CM11 Pyranometers

The CM11 incorporates a 100-thermocouple sensor, imprinted on a thick-film substrate, housed under K5 glass domes. The sensor is rotationally symmetrical. A white screen prevents the body from heating up. The pyranometer is supplied with a spirit level and screws for accurate levelling. A drying cartridge keeps the interior free from humidity.

All pyranometers are supplied with a calibration certificate which also shows the level of directional error.

#### Specifications

Response time time for 95 % response	< 15 s
---	--------

Zero off-set	
a)response to 200 W m <sup>-2</sup> net thermal radiation (ventilated)	+ 7 W m <sup>-2</sup>
b)response to 5 K h <sup>-1</sup> change in ambient temperature	± 2 W m <sup>-2</sup>
Non-stability percentage change responsivity per year	± 0.5 %
Non-linearity percentage deviation from the responsivity at 500 W m <sup>-2</sup> due to the change in irradiance within 100 W m <sup>-2</sup> to 1000 W m <sup>-2</sup>	± 0.6 %
Directional response for beam radiation (The range of errors caused by assuming that the normal incidence responsivity is valid for all directions when measuring from any direction a beam radiation whose normal incidence irradiation is 1000 W m <sup>-2</sup> )	± 10 W m <sup>-2</sup>
Spectral selectivity percentage deviation of the product of spectral absorptance and spectral transmittance from the corresponding mean within 0.35 µm and 1.5 µm	± 2 %
Temperature response percentage deviation due to change in ambient temperature from -10 to +40 °C relative to 20 °C	±1%
Tilt response percentage deviation from the responsivity at 0° tilt (horizontal) due to change in tilt from 0° to 90° at 1000 W m <sup>-2</sup> irradiance	±0.25%
Viewing angle	2 π sr
Irradiance	0 - 1400 W m <sup>-2</sup> (max.4000 W m <sup>-2</sup> )
Spectral range	305-2800 nm (50% points) 335-2200 nm (95% points)
Sensitivity	between 4 and 6 µV/(W m <sup>-2</sup> )
Impedance	700-1500 Ohm
Receiver paint	Carbon black
Glass domes	Schott K5 optical glass 2 mm thick, 30 mm and 50 mm outer diameter
Desiccant	Silicagel
Spirit level	Sensitivity 0.1 degree

	(bubble half out of the ring) Coincident with base of the instrument. Detector surface and base are coplanar within 0.1°
Materials	Anodized aluminium case. Stainless steel screws in stainless steel bushes. White plastic screen of ASA  Drying cartridge PMMA
Weight	830 g
Cable length	10 m (standard)
Dimensions	91.5 mm total height, 150 mm diameter, 25 mm dome height, 50 mm dome diameter

### B 2.3 Kipp & Zonen Delft BV CM21/31 Pyranometers

Suitable for the measurement of solar irradiance on a plane surface.

- improved specifications in comparison with the CM11.

- also available with quartz domes (CM31) yielding a broader range and reduced offsets.

Essentially the pyranometer CM21 has the same characteristics as the CM11. Some of these specifications have been improved:

Sensitivity  
Impedance  
Temperature response  
Non-linearity  
Response time

#### Specifications

Response time time for 95 % response	< 5 s
Zero off-set	
a) response to 200 W m <sup>-2</sup> net thermal radiation (ventilated)	+ 7 W m <sup>-2</sup>
b) response to 5 K h <sup>-1</sup> change in ambient temperature	± 2 W m <sup>-2</sup>
Non-stability percentage change in responsivity per year	± 0.5 %
Non-linearity percentage deviation from the responsivity at 500 W m <sup>-2</sup> due to the change in irradiance within 100 W m <sup>-2</sup> to 1000 W m <sup>-2</sup>	± 0.25 %
Directional response for beam radiation The range of errors caused by assuming that the normal incidence responsivity is valid for all directions when measuring from any direction a beam radiation whose normal incidence irradiation is 1000 W m <sup>-2</sup>	± 10 W m <sup>-2</sup>

Spectral selectivity percentage deviation of the product of spectral absorptance and spectral transmittance from the corresponding mean within 0.35 $\mu\text{m}$ and 1.5 $\mu\text{m}$	$\pm 2\%$
Temperature response percentage deviation due to change in ambient temperature within an interval of -20 to +50 $^{\circ}\text{C}$ , relative to 20 $^{\circ}\text{C}$ .	$\pm 1\%$
Tilt response percentage deviation from the responsivity at 0 $^{\circ}$ tilt (horizontal) due to change in tilt from 0 $^{\circ}$ to 90 $^{\circ}$ at 1000 $\text{W m}^{-2}$ irradiance	0.25%
Viewing angle	$2 \pi \text{ sr}$
Irradiance	0 - 1400 $\text{W m}^{-2}$ (max.4000 $\text{W m}^{-2}$ )
Spectral range	305-2800 nm (50% points) 335-2200 nm (95% points)
Sensitivity	between 7 and 25 $\mu\text{V W}^{-1}\text{m}^2$
Impedance	40-100 Ohm
Receiver paint	Carbon black
Glass domes	Schott K5 optical glass 2 mm thick, 30 mm and 50 mm outer diameter
Desiccant	Silicagel
Spirit level	Sensitivity 0.1 $^{\circ}$ (bubble half out of the ring) Coincide with base of the instrument. Detector surface and base are coplanar within 0.1 $^{\circ}$
Materials	Anodized aluminium case Stainless steel screws in stainless steel bushes. White plastic screen of ASA  Drying cartridge PMMA
Weight	830 g
Cable length	10 m
Dimensions	91.5 mm total height, 150 mm diameter, 25 mm dome height, 50 mm dome diameter

#### B 2.4 Kipp and Zonen Delft BV PYRANOMETER CM 31 (additions/changes to CM 21)

Spectral Range	200-4000 nm (50% points) 290-3500 nm (95% points)
Spectral selectivity	max. 2% in the spectral range 300 to 3000 nm
Zero off-set response to 200 $\text{W m}^{-2}$	+ 4 $\text{W m}^{-2}$

Directional response  
for beam radiation

5 W m<sup>-2</sup>

Quartz domes

Infrasil II

### B 2.5 Carter-Scott Middleton EP09 Pyranometer

The EP09 sensor has an upwards facing black receiver disk with a radial heat conduction path for rapid response. An identical (reference) disk faces into the instrument body. The temperature difference between the disks is a direct function of the intensity of radiation absorbed by the receiver disk. The disk temperature is precisely determined with miniature thin-film Platinum Resistance Elements which give the instrument exceptional linearity and stability. Zero offset and signal gain can be externally trimmed via access holes in the base.

#### Specifications

Response Time  
time for 95% response

< 10s

Zero off-set

a) response to 200 W m<sup>-2</sup>  
net thermal radiation (Ventilated)

+ 6 W m<sup>-2</sup>

b) response to 5 °C/hour change  
in ambient temperature

< 2 W m<sup>-2</sup>

Non-stability  
Percentage change in  
responsivity per year

< -0.6 %

Non-linearity  
percentage deviation from the  
responsivity at 500 W m<sup>-2</sup> due  
to change in irradiance  
within 100 W m<sup>-2</sup> to 1000 W m<sup>-2</sup>

< ± 0.25 %

Directional response for  
beam radiation from 0 to 85 °

< ± 10 W m<sup>-2</sup>

Spectral Selectivity  
percentage deviation of the product  
of spectral absorptance and spectral  
transmittance from the corresponding  
mean within 0.35 µm and 1.5 µm

+0.5 %, -1.5 %

Tilt response  
percentage deviation from the  
responsivity at 0° tilt (horizontal)  
due to change in tilt from 0° to 90°  
at 1000 W m<sup>-2</sup> irradiance

< ± 0.1 %

Temperature response  
percentage deviation due to change  
in ambient temperature within an  
interval of 50 °C

< 1 %

Field of view

2 π sr

Irradiance

0 - 2000 W m<sup>-2</sup>

Spectral range

300 - 3000 nm (nominal)

Signal output (responsivity)	1.00 mV/W m <sup>-2</sup>
Signal resolution	< 1.0 W m <sup>-2</sup>
Zero point ( at 20 °C )	± 1.5 W m <sup>-2</sup>
Zero point temperature coefficient	< ± 0.05 W m <sup>-2</sup> / °C
Calibration accuracy	± 2 % (factory certificate); traceable NATA Certificate available as extra cost option
Operating temperature	-35 to +60 °C
Power supply requirement	5.5 to 14.5 VDC, 10 mA
Measurement instrument requirement	-0.05 to +2.0 VDC, > 1MΩ
Standby mode	Shutdown input: 2 to 14.5 V Standby current draw: 0.25 mA Startup settling time: 1.5s
Hermetic seal integrity output (fail when approx. 5% RH at 20 °C )	OK = 0.5 to 1.0 V Fail = 0 to 0.2 V
Temperature output	10 mV/°C (0.20V = 20 °C)
Bubble level resolution	0.1°
Desiccant	Silica gel
Lead	6m; 8-core
Mounting	Central M10 hole, plus pair M4 holes on 65mm P.C.D.
Weight	0.8 kg (excluding lead)

#### B 2.6 Eko MS-802 Pyranometer

High precision pyranometer for photovoltaic applications and other high precision measurements

The sensing element consists of a wire-wound thermopile constructed of electroplated copper on constantan, covered with black paint that has a spectrally flat absorption response. It is protected from environment effects (wind, etc.) Using two concentric glass dome covers.

#### Specifications

Directional response	less than ± 10 W m <sup>-2</sup>
Temperature response	1 % (within an interval for 50 °C)
Non-linearity	± 0.2 % (from 100 to 1000 W m <sup>-2</sup> )
Spectral range	300 to 2800 nm

## B 2.7 Eppley Black and White Pyranometer (Model 8-48)

The Black and White Pyranometer has a detector consisting of a differential thermopile with the hot-junction receivers blackened and the cold-junction receivers whitened. The receiver is of radial wire-wound plated construction with the black segments coated with a flat black coating and the white with Barium Sulfate. Built-in temperature compensation with thermistor circuitry is incorporated to free the instrument from effects of ambient temperature. A precision ground optical glass hemisphere of Schott glass WG295 uniformly transmits energy from 0.285 to 2.8  $\mu\text{m}$ .

### Specifications

Sensitivity	approx. 10 $\mu\text{V}/\text{W m}^{-2}$
Impedance	approx. 350 Ohms
Temperature Dependence	$\pm 1.5\%$ over ambient temperature range -20 to +40 $^{\circ}\text{C}$
Linearity	$\pm 1.0\%$ from 0 to 1400 $\text{W m}^{-2}$
Response time	5 seconds (1/e signal)
Cosine	$\pm 2\%$ from normalization 0-70 $^{\circ}$ zenith angle $\pm 5\%$ from normalization 70-80 $^{\circ}$ zenith angle
Mechanical Vibration	tested up to 20 g's without damage
Calibration	integrating hemisphere
Size	5.75 inch diameter, 2.75 inches high
Weight	2 pounds

## B 2.8 Schenk Star Pyranometer

The measuring principle of the star pyranometer is the measurement of the temperature difference between white and black painted sectors so that the result is not affected by ambient temperature. A precisely cut dome shields the sensing elements from environmental factors.

A drying cartridge keeps the interior free from humidity. An optional protective housing enables measurements in cold weather.

### Technical Data

Measuring range	0 to 1500 $\text{W m}^{-2}$
Spectral sensitivity	0.3 to 3 $\mu\text{m}$
Output	About 15 $\mu\text{V}/\text{W m}^{-2}$ or 4 ... 20 $\text{mA} = 0 \dots 1500 \text{ W m}^{-2}$
Impedance	About 35 Ohm
Ambient temperature	-40 $^{\circ}\text{C}$ to +60 $^{\circ}\text{C}$
Resolution	< 1 $\text{W m}^{-2}$
Stability	< 1% per year ( temporary operation )
Cosine response	< 3 % of the value, zenith angle 0 $^{\circ}$ - 80 $^{\circ}$
Azimuth response	< 3 % of the value
Temperature effect	< 1 % of the value between -20 $^{\circ}\text{C}$ to + 40 $^{\circ}\text{C}$

Linearity	< 0.5 % in the range 0.5 to 1330 W m <sup>-2</sup>
Response time	< 25 sec. (95%), < 45 sec. (99%)
Weight	1.0 kg
Cable	2-polar shielded, 3 m length

### B 3. Cavity Radiometers and Pyrheliometers

#### B 3.1 Eppley Laboratory HF/AHF Cavity Radiometer

The self-calibrating Absolute Cavity Pyrheliometer has been a reference standard device for many years. The sensor consists of a balanced cavity receiver pair attached to a circular wirewound and plated thermopile. The blackened cavity receivers are fitted with heater windings which allow for absolute operation using the electrical substitution method, which relates radiant power to electrical power in SI units. The forward cavity views the direct solar beam through a precision aperture. The precision aperture area is nominally 50 mm<sup>2</sup> and is measured for each unit. The rear receiver views an ambient temperature blackbody. The HF radiometer element with baffle tube and blackbody are fitted into an outer tube which acts as the enclosure of the instrument. The instrument is weather proof when the window is mounted. The model AHF has an automatic shutter attached to the outer tube. A separate, mounted window is supplied with each unit for continuous operation of the radiometer, but at reduced accuracy. An adaptor is supplied for mounting to Eppley solar trackers. The HF cavity radiometer has been used for measurement of the extraterrestrial solar radiation from the Nimbus 7 ( 14 years) and the LDEF (6 years) satellites and is space proven.

The operation of the cavity radiometer, and the measurement of the required parameters, is performed using the appropriate control box. The control functions include setting of the calibration heater power level, activation of the calibration heater, selection of the signals to be measured and control of the meter measurement functions and ranges. The measured parameters include the thermopile signal, the heater voltage and the heater current which is measured as the voltage drop across a 10 LI precision resistor. The instrument temperature may also be measured using an internally mounted thermistor. The meter resolution of 100 nV allows for a thermopile signal equivalent in radiation of approximately 0.1 W m<sup>-2</sup> .

Control boxes for manual only, manual and automatic and automatic only operation are available. The control box can operate either one radiometer in the measurement mode or two radiometers in the comparison mode by changing from single to dual operations cable. Two cables are supplied with each unit. The automatic operation allows for computer control of all shuttering, calibration heating and measurement functions. Calculation operations and data storage are also possible under computer control. Programs for independent, automatic measurement and cavity radiometer comparison are supplied with automatic units.

Although these are absolute devices, the radiometers are compared with the EPLAB reference cavity radiometers which have participated in the EPC's and other inter-comparisons and are directly traceable to the WRR. The References are HF's SN 14915 and SN 27798. The HF which is part of the WSG is SN 18748.

#### Specifications

Radiometer:	
Sensor:	60 junction circular wirewound and plated thermopile with balanced cavity receivers ( $\approx 350 \Omega$ )
Cavity:	Inverted cone within a cylinder coated with specular black paint. emissivity $\geq 0.999$
Aperture area:	nominal 50 mm <sup>2</sup> : each measured using precision pins
Field of view:	5° central; 1.6° unencumbered (0.8° slope); 8.5° max.
Heater resistance:	150 $\Omega$ (Approx.)
Irradiance sensitivity:	1 $\mu\text{V W}^{-1}\text{m}^2$ (approx)
Size:	5.5 in. diameter at base; 13.32 in long without connector and adaptor, 7 in x 5 in at shutter housing; 3.5 in. dia. outer tube
Weight	9.25 lb; 11.5 lb with tracker adaptor
Window material:	Corning 7940

## CONTROL BOX:

Size:	7 in. high x 17 in. wide x 16 in. deep
Weight:	23 lb (approx)
Power requirement:	115 VAC 60 @ or 230 VAC 50 Hz selectable

### B 3.2 PMOD/PMO6

PMO-6 Absolute radiometer (excerpted from Applied Optics, Vol. 25, Page 4173, November 15, 1986)

The PMO6 radiometer is based on the measurement of a heat flux using an electrically calibrated heat flux transducer. The radiation is absorbed in a cavity which ensures a high absorptivity over the spectral - range of interest for solar radiometry. The heat flux transducer consists of a thermal impedance with resistance thermometers to sense the temperature difference across it. Heat developed in the cavity is conducted to the heat sink of the instrument and the resulting temperature difference across the thermal impedance is sensed. The sensitivity of the heat flux transducer is calibrated by shading the cavity and measuring the temperature difference while dissipating a known amount of electrical power in a heater element which is mounted inside the cavity. It is advantageous to determine the electrical power which is needed to produce the same temperature difference as was observed with the cavity irradiated, because in this case the heat losses are the same during radiative and electrical heating—even if nonlinear effects are involved. During practical operation of the instrument, an electronic circuit maintains the temperature signal constant by controlling the power fed to the cavity heater—independent of the mode, that is, whether the cavity is shaded or irradiated. The substituted radiative power is then equal to the difference in electrical power as measured during the shaded and irradiated periods, respectively.

Changes of the temperature of the heat sink may also produce a temperature signal. Therefore, two heat flux transducers with matched time constants are combined to form a differential heat flux transducer. The temperature difference measured between the two tops of the thermal impedances is then—depending on the quality of the matching—largely insensitive to changes of the temperature of the heat sink.

The instrument measures irradiance, hence its receiver area has to be accurately known. A precision aperture of nominally 5-mm diameter is placed in front of the primary cavity. A second aperture of 8.35-mm diameter acting as a view-limiting aperture and defining a field of view of  $5^\circ$  is placed 95.4 mm in front of the precision aperture. This geometry puts only a moderate  $\sim 0.75^\circ$  requirement on the solar pointing. All the apertures of the so-called muffler are in the shadow of the view-limiting aperture. The purpose of the muffler is to reduce the sensitivity to wind effects and to increase the thermal mass of the heat sink of the instrument.

The cavities are made of electro-deposited silver and are gold-plated on their outside. They are soldered onto the thermal impedances made from stainless steel. The thermal impedances are in turn soldered to the copper heat sink of the instrument. The heater element in the cavities is a flexible printed circuit. It is etched in a  $5\ \mu\text{m}$  constantan foil supported by a  $20\ \mu\text{m}$  Kapton foil. It is glued to the cone-shaped part of the cavity at the same spot as the radiation entering the cavity first impinges on the cavity walls. Its resistance is  $\sim 90\ \Omega$  and a four-wire terminal configuration is provided to allow for accurate measurements of the electrical power dissipated in the heater. All the inner surfaces of the cavity are coated with a thin layer of specularly reflecting black paint. The resistance thermometers are made from copper wire of 0.03-mm diameter by winding it around the joint of the thermal impedance with the cavity and the heat sink, respectively. The four thermometers of the two heat flux transducers, each with a resistance of  $\sim 100\ \Omega$ , are wired in a bridge circuit to sense the difference of temperature between the two cavities. The bridge is trimmed with a piece of the same copper wire to yield zero response with the two cavities held at the same temperature. The precision aperture is fabricated from tempered stainless steel. Its roundness is better than  $0.2\ \mu\text{m}$  and the cylindrical part of the aperture edges has a length of only  $20\ \mu\text{m}$ .

### Characteristics

Working Principle	Electrically calibrated cavity radiometer. Automatic operation with alternating observation and reference phases.
-------------------	---

Receiver	Cavity with inverted cone shaped bottom , coated with specular black paint cavity (absorptance : >.9998).		
Detector	Electrically calibrated differential heat flux transducer with resistance thermometers as sensors		
Accuracy	Measurement uncertainty (referred to SI-Units) < $\pm 0.25\%$		
Precision	$\pm 0.01\%$		
<b>Mechanical Dimensions</b>			
	Diameter	75 mm	
	Length	200 mm	
	Weight, approx.	2.2 kg	
	Field of view (full angle)	5°	
	Slope angle	1°	
	Receiver aperture diameter (nominal)	5 mm	
<b>Control Electronics</b>			
	Plug-in circuits (electronic prints) inserted in a cabinet with power supply and control panel		
	Cabinet	width	290 mm
		height	70 mm
		depth	330 mm
Power Supply	110 V/220 V 50 Hz/60 Hz 10 W		

### B 3.3 Eppley Normal Incidence Pyrheliometer

The Eppley Normal Incidence Pyrheliometer (NIP), as the name implies, was designed for the measurement of solar radiation at normal incidence.

The NIP incorporates a wire-wound thermopile at the base of a tube, the aperture of which bears a ratio to its length of 1 to 10, subtending an angle of 5°43'30". The inside of the brass tube is blackened and suitably diaphragmed. The tube is filled with dry air at atmospheric pressure and sealed at the viewing end by an insert carrying a 1 mm thick, Infrasil II window. Two flanges, one at each end of the tube, are provided with a sighting arrangement for aiming the pyrheliometer directly at the sun. A manually rotatable wheel which can accommodate three filters, while leaving one aperture free, is provided.

The pyrheliometer is mounted on a power-driven equatorial mount for continuous readings.

A calibration certificate traceable to the World Radiation Reference and a temperature compensation curve are included.

#### **Specifications**

Sensitivity	approx. $8 \mu\text{V W}^{-1}\text{m}^2$
Impedance	approx 200 $\Omega$
Temperature Dependence	$\pm 1\%$ over the ambient temperature range $-20^\circ$ $+40^\circ$ C (temperature compensation of sensitivity can be supplied over other ranges at additional charge)

Linearity	$\pm 5\%$ from 0 to $1400 \text{ W m}^{-2}$
Response time	1 second (1/e signal)
Mechanical vibration	tested up to 20 g's without damage
Calibration	reference Eppley primary standard group of pyrheliometers
Size	11 inches long
Weight	5 pounds

#### B 3.4 Kipp and Zonen Delft BV CH1

The pyrheliometer CH1 is designed to measure direct solar irradiance at normal incidence. Its main characteristics are:

Built in accordance with ISO 9060 specifications for first class pyrheliometer

Slope and opening angle according to WMO recommendations

Equipped with an easily serviceable drying cartridge

Suitable for continuous outdoor use

According to clients' specifications: (optional) internal filter, sensor temperature measurement, extended cable and connector

#### Specifications

Response time	95%	7 s
	99%	10 s
Zero offset: Caused by 5 K/H change in ambient temperature		$\pm 3 \text{ W m}^{-2}$
Non-stability		$< \pm 1 \%$ per year
Non-linearity		$\pm 0.2 \%$ ( $< 1000 \text{ W/m}$ )
Spectral selectivity within 0.35 to $1.5 \mu\text{m}$ .		$\pm 0.5 \%$
Temperature response (%) deviation due to ambient temperature (relative to $20 \text{ }^\circ\text{C}$ )		$\pm 1 \%$ , -20 to +50 $\pm 1.5 \%$ , -40 to +70
Tilt response		None
Traceability		To WRR
Sensitivity		$7\text{-}15 \mu\text{V W}^{-1}\text{m}^2$
Spectral range		$0.2$ to $4 \mu\text{m}$ , 50 % points
Impedance		$50\text{-}70 \Omega$ .
Irradiance		$0\text{-}4000 \text{ W m}^{-2}$
Operating temperature		$-30$ to $+60 \text{ }^\circ\text{C}$

Full opening angle	5° ± 0.2°
Slope Angle	1° ± 0.2°
Sight accuracy	+0.2° from optical axis
Materials	Anodised aluminum case, stainless steel screws
Window material	Infrasil 1-301
Weight	700 grams
Desiccant	Silica gel
Cable length	10 m (Standard)
Absorber coating	Kipp & Zonen carbon black

### B 3.5 Eko MS-53A Pyrheliometer

This pyrheliometer measures the intensity of a radiant beam at normal incidence that comes only from the solar disk which includes about 5 degrees of circumsolar radiation. The sensor of this instrument, designed in conformity with WMO specifications, is mounted on a tracking system to be always directed to the sun. The tracking system incorporated a sun sensor for tracking during clear weather, and changes automatically to a mechanical mode during cloudy weather.

#### **Specifications**

Sensitivity	about 4 mV/kW m <sup>-2</sup>
Aperture angle	2.5 degree (half angle)
Tracking System	
Mechanism	2-axis pulse motor
Angular step	less than 0.01 degree
Tracking process	automatic commutation between sun sensor mode and mechanical mode

### B 3.6 Carter-Scott Middleton DN5 & DN5-E Pyrheliometer

The Middleton DN5 is an affordable precision pyrheliometer for measuring the solar direct radiation when aimed at the sun. It exceeds the ISO9060 specifications for a First Class pyrheliometer. The DN5 has a passive microvolt output, and the DN5-E version has an in-built signal amplifier to give a millivolt output for easy measurement.

Twin-thermopile sensor accommodates rapid temperature changes

Broad bandwidth (0.2 to 5 μm), and flat spectral response

Flush-mount window to prevent obstruction by rain or debris

Fully sealed construction with internal desiccant

DN5-E has low-noise signal amplifier with negligible drift

Condition of desiccant is easy to inspect visually

Thermistor output provided for sensor temperature

Aiming diopter conveniently located on top of instrument

Compact size and light weight

Window is optical sapphire for chemical and scratch resistance

Marine-grade aluminium, hard anodised, for corrosion resistance

The DN5 pyrheliometer has a twin-thermopile sensor embedded in a thermal-mass that is isolated from the instrument body. Optical geometry, and baffling, is set by four precisely located apertures. The instrument is easy to dismantle, and the window is simple to replace.

### Specification

Response Time time for 95% response	< 10s
Zero off-set response to 5 °C/hour change in ambient temperature	< ± 1 W m <sup>-2</sup>
Non-stability Percentage change in responsivity per year	< ± 1%
Non-linearity 100 W m <sup>-2</sup> to 1000 W m <sup>-2</sup>	< ± 0.5 %
Spectral Selectivity percentage deviation of the product of spectral absorptance and spectral transmittance from the corresponding mean within 0,35 µm and 1,5 µm	± 0.5 %
Tilt response (at 1000 W m <sup>-2</sup> )	None
Temperature response percentage deviation due to change in ambient temperature within an interval of 50 °C (-10 to +40°C)	± 1 %
Full opening angle	5°
Slope angle	1°
Limit angle	4°
Irradiance	0 - 4000 W m <sup>-2</sup>
Spectral Range (nominal)	200 - 5000 nm
Sensitivity (typical)	7 µV/W m <sup>-2</sup> (DN5) 1 mV/W m <sup>-2</sup> (DN5-E)
Calibration Accuracy	± 2 % (factory certificate); traceable NATA Certificate available as extra cost option
Operating temperature	-30 to +60 °C
Output Impedance (DN5)	45 - 50 Ω
Power supply requirement (DN5-E)	5.5 to 14.5 VDC, 6mA
Standby mode (optional on DN5-E)	Shutdown input: 2 to 14.5 V

	Standby current draw: 0.1 Ma Startup settling time: 1.5s
Temperature output	YSI 44031 thermistor (10k $\Omega$ @ 25°C)
Window material	Optical sapphire, 2mm thick
Body construction	Marine grade aluminium, hard anodised
Fasteners	Stainless steel
Desiccant	Silica gel
Lead	6 m
Weight	0.75 kg (excluding lead)

An optional FW01 filterwheel is available for the DN5/DN5-E. The five position FW01 has three glass filters (Schott OG530, RG630, RG695), open position, and blocked position.

## B 4. Pyrgeometers

### B 4.1 Eppley Precision Infrared Radiometer (PIR)

This pyrgeometer is a development of the Eppley Precision Spectral Pyranometer. It is intended for unidirectional operation in the measurement, separately, of incoming or outgoing terrestrial radiation as distinct from net long-wave flux. This instrument comprises the same type of wirewound-plated thermopile detector and cast bronze desiccated case as the PSP. Temperature compensation of detector response is likewise incorporated. Radiation emitted by the detector in its corresponding orientation is automatically compensated, eliminating that portion of the signal. A battery voltage, precisely controlled by a thermistor which senses detector temperature continuously, is introduced into the principle electrical circuit.

Another innovation is aimed at isolating infrared radiation from solar short-wave radiation in daytime. This is accomplished by replacing the glass hemispherical system of the pyranometer with a silicon hemisphere. On the inner surface, there is a vacuum-deposited interference filter. The transmission range of the pyrgeometer window is approximately 3.5-50  $\mu\text{m}$ .

A calibration certificate and a wiring diagram are included.

#### Specifications

Sensitivity:	approx. 4 $\mu\text{V W}^{-1}\text{m}^2$
Impedance:	approx. 700 $\Omega$ .
Temperature Dependence:	$\pm 1$ % over ambient temp. range -20 to +40 $^{\circ}\text{C}$ .
Linearity:	$\pm 1$ % from 0 to 700 $\text{W m}^{-2}$
Response time:	2 seconds (1/e signal).
Cosine:	better than 5% from normalization, insignificant for a diffuse source.
Mechanical Vibration:	tested up to 20 g's without damage.
Calibration:	blackbody reference.
Size:	5.75 inch diameter, 3.5 inches high.
Weight:	7 pounds
Orientation:	Performance is not affected by orientation or tilt.
Temperature Measurement	Thermistor YSI 44031
Specification for ventilator	
Input Power:	110 - 120 V, 60 Hz (or other specified supply).
Output:	approx. 30 CFM.
Size:	8 inch diameter, 5.75 inches high.
Weight:	5.5 pounds.

### B 4.2 Eko MS-201 Precision Pyrgeometer

For measurement of long wave radiation, beyond 3  $\mu\text{m}$ .

A specially coated silicon dome transmits incoming radiation with wavelength of more than 3 micron, by cutting off shorter wavelengths. The output of the thermopile sensor is added automatically to the output of a built-in temperature compensation circuit that incorporates a thermistor to produce the correct electrical signal corresponding to the incident infrared radiation.

### Specifications

Spectral Range	3 to 50 $\mu\text{m}$
Accuracy	$\pm 5 \%$
Power supply	3 Volt lithium battery Battery life: 300 days
Temperature Measurement	Thermistor or PT-100

### B 4.3 Kipp and Zonen Delft CG4 Pyrgeometer

The CG4 has been designed for meteorological measurements of downward atmospheric infrared radiation with high reliability and accuracy. The instrument uses a specially designed silicon window, that although not hemispherical, provides a  $180^\circ$  field of view with good cosine response. A diamond-like surface protects the outer surface of the window, while the inner surface filters all solar radiation. The design of the instrument is such that solar radiation absorbed by the window is conducted away to reduce the solar heating effect. This reduces the need for dome heating correction terms and shading from the sun.

### Specifications

Spectral Range	4.5 to 42 $\mu\text{m}$
Sensitivity	10 $\mu\text{V W}^{-1}\text{m}^2$ (nominal)
Impedance	40 - 200 $\Omega$ (nominal)
Response Time	25 s (95%) < 8 s (63%)
Non-linearity	$< \pm 1\%$ (-250 to + 250 $\text{W m}^{-2}$ )
Temperature Dependence	Max. $\pm 1\%$ (-20 to + 50 $^\circ\text{C}$ )
Tilt Error	Max. 1% when facing downwards
Operating Temperature	-40 to +80 $^\circ\text{C}$
Field of View	$180^\circ$
Non-stability	$< \pm 1\%$ sensitivity change per year
Temperature Measurement	Thermistor YSI 44031 or Pt-100 Heraeus M-GX 1013
Receiver Paint	carbon black
Window	silicon with solar blind filter and diamond-like coating
Weight	1050 g
Dimensions	W x H 150 x 76 mm

## B 5. Sunphotometers and Spectral Radiometers

### B 5.1 Kipp and Zonen POM-01L Sky Radiometer

The POM-01L Sky Radiometer is a research instrument intended for the analysis and determination of optical aerosol depth and particle size distribution. The POM-01L is capable of performing high accuracy angular and spectral scans for both direct and diffuse sky solar radiation, across seven different spectral bandwidths. The POM-01L consists of a fast automated tracking system, multi-filter spectral scanning radiometer, control unit, and operating software. The POM-01L's unique single (temperature stabilized) detector design completely eliminates sensitivity differential errors, or temperature dependence errors, inherent in dual/twin detector type instruments. In addition, both absolute (utilizing improved Langley method) and solid opening angle calibrations can be performed on site.

### B 5.2 WRC/PMOD Precision Filter Radiometer (PFR)

The Precision Filter Radiometer (PFR) is a research grade instrument to measure direct solar irradiance in 4 narrow spectral bands centered at wavelengths recommended by World Meteorological Organization for the determination of atmospheric aerosol optical depth (AOD). The PFR consists of an optical sensor head with signal amplifiers and an electronic box with power supply and data logger. Both units are designed for automated operation under harsh weather conditions when the sensor is mounted on a suitable solar tracker. The data logger communicates over a serial link with software available for Windows PC's and has a data storage capacity of 1 month.

The instrument is designed for radiometric stability. The detectors are operated in a controlled environment and are exposed to solar radiation only during actual measurements. A Peltier thermostat maintains the ion-assisted deposition filters and silicon detectors at a constant temperature of 20.5 +/- 0.1 °C over an ambient temperature range from -20 °C to +35 °C; an internal shutter shades the detector between measurements and the vacuum tight sensor head is filled with dry nitrogen gas. At PMOD/WRC, the PFR spectral sensitivity can be calibrated periodically against an absolute trap detector traceable to a primary cryogenic radiometer at Physikalisch-Technische Bundesanstalt, Berlin.

Internal barometric and electronic pointing sensors plus a complementary set of house-keeping parameters support evaluation and quality control of the measurements.

### Specifications

Table B 5.1. Optical characteristics of typical instrument.

	Ch1	Ch2	Ch3	Ch4	unit
Central Wavelength	861.6	500.5	411.4	367.6	nm
FWHM bandwidth	5.4	5	4.5	3.8	nm
Sensitivity	0.28	0.49	0.46	0.28	$A m^{-2} nm^{-1}$
Extraterrestrial Signal	3.47	3.88	3.81	4.24	V

Field of View

opening angle 2.5°  
slope angle 0.7°

Entrance Window 3mm fused silica

Pointing monitor +/- 0.75° in two axis

Calibration:

Extraterrestrial  $V_0$  comparison with PMOD/WORCC standard, calibrated at high altitude observatories.

Radiometric against absolute trap detector of FEL lamp.

**Mechanical:**

Instrument dimension	i x L: 89 x 390mm
Instrument mass	3 kg
Control box dimensions	H x L x W: 300 x 250 x 160 mm
Control box mass	8.250 kg + cables
Cable length	10 m to instrument, <30 m to PC and mains

**Electrical:**

Power requirement	85 ... 264 VAC, 40..400 Hz, 20 W max
Serial data link	RS232, 9600 baud, 8/1/0 bits

**B 5.3 EKO Instruments MS-110A Sunphotometer**

The EKO Sunphotometer is designed to determine atmospheric turbidity by measuring the attenuation of direct solar radiation at a defined spectral band. The sunphotometer sensor is mounted on a 2-axis tracking mechanism for fully automatic operation. Direct solar radiation that passes through the incidence part of the instrument is separated into several spectral components by interference filters mounted on a filter wheel, which is then detected by a silicon photodiode sensor that emits a current proportional to the spectral component, the later conversion to a voltage output by an I=V converter.

**Specifications**

Aperture angle	2.3°
Slope angle	0.8°
Certified accuracy	+/- 1.0% (as per calibration against reference instrument)

**B 5.4 Yankee Environmental Systems Model SPUV Sunphotometer**

**Instrument Design:** The interference filters used in this instrument have exceptional long-term stability and out-of-band rejection properties. The filters and detectors are located in a thermally controlled enclosure and are held at a constant temperature so that they do not experience thermal cycling due to day-night temperature variation. In addition, the design incorporates solar energy absorbing pre-filters on UV channels to minimize the amount of out-of-band energy that those filters are exposed to during operation.

**Specifications**

Wavelengths	Standard configuration includes choice of any six or ten of the following wavelengths: 300, 305.5, 311.4, 317.5, 325.5, 332.5, 368, 500, 615, 673, 778, 870, or 940 nm (UV filters: 2 nm FWHM bandpass; visible filters: 10 nm FWHM)
Field of view	Opening angle of 2.5°
Temperature range	+/- 50 °C
Signal output	Analog outputs 0-4 VDC low impedance, single-ended, interfaces to YESDAS datalogger
Dimensions	L x D 285 x 175 mm
Weight	5 kg
Power input	+11 to 14 VDC, @2A - startup; drops to 1A typical
Tracker	The base plate of the SPUV adapts to most solar trackers

## B 5.5 CIMEL Electronique Automatic Sun Tracking Photometer CE 318

The CE 318 automatic sun tracking photometer has been designed and realized to be a very accurate sun photometer with all the qualities of a field instrument: motorized, portable, autonomous (solar powered) and automatic.

### Specifications

Two types

CE 318-1: standard model with 5 filters 440, 670, 870, 936, 1020 nm

CE 318-2: polarized model with 7 filters 440, 670,870,870,870,936,1020 nm

Components	Optical head with 2 collimators
Field of view	Solar collimator 1.2° Sky collimator 1.2°
Bandwidth	10 nm at FWHM
Detector	UV enhanced silicon detector for the sun Silicon detector for the sky
Electronic box	
Robot for sun tracking	
Operating temperature	-30 to +60 °C
Sun Tracking Method	Tracking in zenith and azimuth planes Active tracking by a 4-quadrant detector Accuracy better than 0.10°
Power Requirements	Internal batteries for the optical head External batteries for the robot Rechargeable by solar panels or 220 VAC
Data output and transfer	Local reading Storage in EPROM readable on a PC Data Collection Systems through satellites in option

## B 5.6 Carter-Scott Design Middleton SP02 Sunphotometer

The Middleton SP02 Sunphotometer is a simple low-cost instrument for the determination of the spectral optical depth of the atmosphere. It consists of four precision spectro-pyrheliometers axially aligned in a sealed enclosure.

- Four narrow-bandwidth channels operate simultaneously
- Low- noise signal amplifiers with negligible drift
- External gain trim for each channel (via rear access ports)
- Temperature output for thermal response correction

### Specifications

Field of View	2.50° opening angle)
Slope angle	1.60°
Limit angle	3.5°
Filters (10 nm FWHM)	aerosol version: 412, 500, 675, 862 nm ozone version: 368, 500, 610, 778 nm water vapour version: 500, 778, 812, 862 nm

Cavity size; CWL tolerance	3-cavity, Ø25 mm; ±2 nm
Side-band blocking	OD4, UV to 1200 nm
Detector type; active area	UV si-photodiode; 33 mm <sup>2</sup>
Sensitivity gain setting x 4 channels	high/low by jumper; trim via multi-turn pot
Output signal x 4 channels	-0.05 to 4.5 VDC max.
Resolution	<0.005OD (Langley method)
Response time	0.2 s to 99%
Operating temperature	-30 °C to +70 °C
Power supply requirement	5.5 to 14.5 VDC, 20 mA
Temperature output	10 mV °C <sup>-1</sup> (0.20 V = 20 °C)
Desiccant	silica gel (visible through front window)
Interface lead	8-core shielded cable, 5 m (free end is unterminated)
Mounting method	Ø25 mm (1") female clamp, with adjustable alignment
Weight	1.25 kg (excluding 0.5 kg lead)

#### B 5.7 Carter-Scott Design Middleton SP01 Sunphotometer

The SP01 version has fixed field stops and operates in sun photometer mode only.

- Four narrow-bandwidths measured simultaneously
- Detectors and filters held at constant temperature to enhance stability
- Low- noise signal amplifiers with negligible zero offset drift
- Three gain selections accommodate a wide range of signal strengths
- Motorised field stop on SP01-A can pause for signal zero check
- Weather-proof aluminum housing

#### Specifications

##### (A) Spectro-Pyrheliometer Tube

Dimension	48 x 312 nm	
Field of view:	sun photometer field stop	2.4° (1.2° opening)
	solar aureole field stop	opening angle 3° - 5°, centre-blocked
	(SP01-A only)	
Slope angle (with 2.4° field stop)	0.9° (limit angle = 1.5°)	
Filter wavelength and bandpass (Optional filters)	368BP5nm; 412BP5; 500BP5; 862BP5 675BP5; 778BP5; 812BP5	
Filter size and CWL tolerance	Ø25 mm, ± 2 nm	
Sensitivity gain selection (by jumper)	low (= medium x 0.2); medium; high (= medium x 5)	
Output signal	-0.05 to +8.0 VDC max	
Response time	2 s to 99%	

Detector temperature control	selection: 30°C, 40°C, 50°C (by jumper on circuit board); stability $\pm 0.1$ °C warm up = 5°C min <sup>-1</sup> ; cooling time constant (63%) = 10 min
Operating temperature	-30 °C to +70 °C
Sensor (Hamamatsu)	UV enhanced silicon photodiode (190 nm - 1100 nm)
(B) Housing Control Box	
Size	housing: Ø180 x 470 mm control box: 280(L) x 230 (W) x 110 (H) mm
Mounting method	Ø25 mm side clamp (female), with adjustable alignmet
Interface leads (housing to control box)	6 m shielded cables (plugs on both ends)
Mains power	110 V or 240 V AC, 50 W
SP01-A motor control input lines (TTL)	forward/reverse (set/reset by alternate pulses) centre stop (will halt index between field stops)
SP01-A motor control output lines (TTL)	forward limit; centre stop; reverse limit
Construction:	housing aluminium, hard anodised + gloss white polyurethane window glass (300 nm - 3000 nm transmission) control box painted aluminium, IP65 sealed fasteners stainless steel

## **Annex C The Geometry and Measurement of Diffuse Radiation**

This annex provides the report of the BSRN Working Group on Diffuse Measurements that describes in detail the geometry and uncertainties associated with the measurement of diffuse radiation with tracking shade instrumentation.

## **C 1. Final Report of the Working Group on Solar Diffuse Shading Geometry**

**Prepared by: G. Major and A. Ohmura**

### **C 1.1 Terms of reference**

The Baseline Surface Radiation Network (BSRN) is a subprogram of the World Climate Research Programme (WCRP). The Fifth Workshop of BSRN formed a Working Group on Solar Diffuse Shading Geometry: " This group was tasked to determine geometric specifications for shading-disc diameters and separations which are appropriate for all combinations of instrumentation typically used to measure diffuse solar irradiance within BSRN accuracy requirements for low-to-moderate aerosol conditions, and which allow for the sum of measured diffuse and direct solar irradiance to meet the accuracy requirements for global solar irradiance, If this is not possible for some combinations of instruments in current use, the working group should recommend geometries which would most closely allow these accuracy requirements to be fulfilled, as well as new instrument dimensions that would be needed to allow the BSRN requirements to be fully satisfied. The group should also address similar questions of geometry for measurement of direct solar irradiance (pyrheliometers). It will report its findings and recommendations at the next BSRN workshop in 2000. Members of this group were identified as A. Ohmura (Chair) and G. Major." (*Report of the Fifth BSRN...*)

The Sixth Workshop of BSRN extended the activity of the working group: "The meeting agreed to the continuation of studies by an Ad-hoc Working Group on Solar Diffuse Shading Geometry, comprised of A. Ohmura (Chairman) and G. Major. The group is to report back on the magnitude of potential errors in diffuse and direct solar irradiance observations due to the actual fields of view used in typical BSRN instrumentation. This assessment is to include the effect of various levels of spectral aerosol optical depth in the atmosphere." (*Report of the Sixth BSRN...*)

The Seventh Workshop of BSRN accepted the results presented by the members of the and terminated the activity of the working group.

### **C 1.2 Activities of the Working Group**

- (1) On the Melbourne BSRN Workshop A. Ohmura presented his theoretical consideration of calculation of the circum-solar radiation contained in the direct solar radiation measurement or excluded from the diffuse solar radiation measurements (*Annex 3 to this WG report (C 2.4)*).
- (2) On the Melbourne BSRN Workshop G. Major presented a work done at the Hungarian Meteorological Service that contains:
  - (i) Basic geometrical data of some diffusometers used on BSRN Stations
  - (ii) Ratios of diffuse radiation values measured in Budapest using 3 different shading spheres with CM pyranometers
  - (iii) a suggested standard geometry of diffusometers (*Annex 1 to this WG report (C2.2)*).
- (3) Taking into account the recommendation of the Melbourne Workshop, G. Major and M. Putsay calculated the "optimal" geometrical parameters of diffusometers for different pyranometer-pyrheliometer pairs and sent the results to the International Pyrheliometer Comparison in Davos, 2000 September (*Annex 2 to this WG Report (C 2.2)*).
- (4) To understand better the behavior of diffusometers Dr. Joseph Michalsky organized a comparison of diffusometers that was held in Billings, Oklahoma, USA, between 24 September and 10 October 2001. On this Intensive Observation Period 14 diffusometers participated. The shading device for all the instruments was Sci-Tec solar tracker with its standard shading sphere (50.8 mm in diameter). The distance between the pyranometer sensor and the center of the shading sphere (arm length) varied between 50 and 51.5 cm. While the shading device could be regarded as identical for all diffusometers, the diameter of the pyranometers sensing surface varied between 4 mm and 32 mm, so the geometrical difference came from the pyranometers. G. Major estimated the possible difference between diffuse measurements due to the different geometry and found that it would not exceed  $2.5 \text{ W m}^{-2}$ . More details in: *Michalsky et al 2002*.
- (5) On the Regina BSRN Workshop A. Ohmura presented numerical results of his theoretical approach for Absolute Cavity Radiometers and CH-1 pyrheliometer as well as for diffusometers used in or suggested for BSRN Stations (*Annex 3 to this WG Report*). The theoretical background behind the methods used by Ohmura and Major is the same, the difference comes from the different order

of integration of the radiation falling on the receiver of the instrument: Ohmura integrates first the direction of the rays, Major integrates first along the surface of the radiation receiver. The numerical solutions of the equations would result some difference between the two type of calculation. Both members of the WG suggests Eppler 8-48 for diffuse measurements at BSRN Stations, however their shading devices differ:

Ohmura's calculations use a sphere with a 28 mm radius and an arm length of 641 mm.  
Major's calculations use a sphere with a 30 mm radius and an arm length of 726 mm.

The circumsolar radiation ( $W m^{-2}$ ) excluded by these two "arrangements" are as follows:

Solar zenith angle, deg	Major's shading	Ohmura's shading
0	12.8	12.9
30	10.6	11.1
60	6.0	6.3

### C 1.3 Statements and recommendations

- (1) The methods of calculating the received/excluded circumsolar radiation by pyrheliometers/diffusometers used by the two members of the WG have identical theoretical background, the numerical values provided by the two methods differ only by few tenths of a Watt (or by few percent in relative sense) due to the numerical approximations of the analytical forms.
- (2) As consequence of different geometry of the pyrheliometers the irradiances received by the pyrheliometric sensors used in BSRN stations might differ by more than  $1 W m^{-2}$  depending on the aureole conditions.
- (3) The differences of irradiances received by the sensors of the diffusometers used in BSRN stations can not exceed the  $5 W m^{-2}$  in any conditions.
- (4) The differences of irradiances received by the sensors of the diffusometers used in BSRN stations could significantly be decreased by changing the size of the shading device or the arm length or both of them (see the annexes to this WG Report).

### C 1.4 References

Report of the Fifth Bsrn Science and Review Workshop (Budapest, Hungary, 18-22 May 1988) WCRP Informal Report No. 10/1998.

Report of the Sixth Bsrn Science and Review Workshop (Melbourne, Australia, 1-5 May 2000) WCRP Informal Report No. 17/2001

Michalsky J.J. and 17 other authors, 2002: *Comparison of Diffuse Shortwave Irradiance Measurements*. In: *Proceedings of the Twelfth Atmospheric Radiation Measurements (ARM) Science Team Meeting, April 8-12, 2002, St Petersburg Florida*.

## C 2. Annex 1 to Diffuse Geometry WG Report: The effect of diffusometer shading geometry

Prepared by G. Major, Z. Nagy and M. Putsay for the BSRN Meeting, May 1-5, 2000, Melbourne

### C 2.1 Introduction

The diffuse radiation is the solar radiation received by the horizontal surface from the above 2 $\pi$  solid angle except the solid angle of solar disk. To exclude the solar disk from the whole sky some kind of shading device should be used. Several years ago, when computer controlled solar trackers were not available, shading rings were used. These rings covered much larger part (varying with the solar declination) of the sky than the solar disk, therefore so called "ring correction" had to be applied to the measured diffuse radiation values. The modern solar trackers keep both the pyrhemometers and the shading disks or shading spheres of diffusometers in the proper position, that is they move altogether with the apparent movement of the Sun. However the shading devices cover somewhat larger solid angle than that of the solar disk (but much less than the shading rings), moreover this extra coverage might be different for different diffusometers, this way the scattered solar radiation coming from the covered (circumsolar) part of the sky might also be different.

***The purpose of this work is to give estimation of the difference of diffuse radiation values measured by diffusometers of different geometry.***

For this end geometrical data of some diffusometers have been collected. The number of involved diffusometers is not large, but it is believed that their range covers that of the most frequently used ones.

The irradiance arising from the circumsolar radiation can be calculated knowing the geometry of the instrument and the distribution of circumsolar radiance (sky function). Since the measurement of the latter one is not a common practice, therefore measurements were made in Budapest by using 3 shading sphere of different size, to obtain a 18 months time series that contains large range of possible natural environmental conditions.

#### **Geometrical data of diffusometers**

The data were provided in 1997 and 1998 by the colleagues operating the instruments in the countries named in Table C 2.1 and by John Hickey of Eppley Co. The used pyranometers are: KippZonen (10 mm), Eppley (5.64 mm) and Star (16 mm). Larger variability is seen in the case of shaders and arm lengths. The shaded solid angle is characterized by the slope and limit angles (the (half)opening angle is their mean value) calculated for the "vertical position", that is when the Sun would be in the zenith. Their slope angles are larger than that of most pyrhemometers (*Major 1995*), this is due to that, that the shaders should be larger than the (outer) glass dome of the pyranometers used in the diffusometer set. On the other side, the long arm of the diffusometers results less limit angles than that of modern pyrhemometers. In most cases it is seen that the dimension of diffusometers were determined so, that the (half)opening angle would fit to that of one of the standard pyrhemometers. The two experimental shading spheres used in the Hungarian diffusometers have been designed so that they would cover the expected range of geometry of BSRN station diffusometers. The same size shading sphere and shading disk have almost the same effect (*Major 1994*).

### C 2.2 The calculation method

To calculate the irradiance measured by a diffusometer from the circumsolar belt, we have to know the circumsolar sky function and the penumbra function of the instrument (Pastiels method). The penumbra function describes the fraction of the sensing surface seen from a given direction. For the directions that decline less from the optical axis (pointed to the solar center) than the slope angle, the penumbra function is equal to 1 (the whole sensor is seen). For the directions that decline more from the optical axis than the limit angle, the penumbra function is equal to 0 (no part of the sensor is seen). The circumsolar sky function describes the distribution of radiance around the Sun (up to some degrees from the solar center).

Country	R mm	r mm	L mm	Slope angle	Limit angle	Opening angle	Remark
Australia I	34.8	10	795	1.79	3.23	2.51	Sky solar
Australia II	34.8	5.64	795	2.10	2.91	2.51	Sky infrared
Austria	45	16	500	3.32	6.96	5.14	To calibrate star pyranometers
Germany I	25	10	298	2.88	6.70	4.79	To fit to Linke-Feussner pyrheliometer
Germany II	30	10	603	1.90	3.80	2.85	To fit to NIP pyrheliometer
Germany III	30	10	687	1.67	3.33	2.50	BSRN station diffusometer
Hungary I	25.4	10	577	1.53	3.51	2.52	SciTec-KIPP diffusometer
Hungary II	30	10	577	1.74	3.72	2.73	Experimental 1
Hungary III	34	10	577	2.23	4.21	3.22	Experimental 2
USA	30.17	5.64	603.3	2.33	3.40	2.86	NOAA diffusometers

Table C 2.1. Geometrical data of diffusometers.

*R*: radius of the shading disk or sphere; *r*: radius of the pyranometer sensing area;

*L*: distance between shader and sensor. The slope, limit and opening angles are valid when the shader is above the pyranometer (Sun at zenith)

#### C 2.2.1 The penumbra functions.

In the case of circular pyrheliometers and diffusometers (when rotational symmetry exists around the optical axis of the instrument) the penumbra functions can be calculated by the relatively simple formula of PASTIELS (see Major 1994). This holds for diffusometers only then, when the Sun is in the zenith. At lower solar elevations the rotational symmetry of diffusometers is not valid, since the radiation receiving surface is not perpendicular to the optical axis. With decreasing solar elevation the slope and limit angles tend to the (half)opening angle (Major 1992, 1994). In this case the geometrical penumbra depends also on the azimuth angle measured around the optical axis in the plane perpendicular to it. To calculate the penumbra function for any position of shader numerical simulation should be used (Major 1994). In Figures C 2.1a and C 2.1b the penumbra functions (averaged in azimuth) are shown for the diffusometers listed in Table C 2.1. As it is seen from Figure C 2.1 the smallest diffuse radiation is measured by the Austrian diffusometer (largest shaded area around the Sun), while the largest one might belong to any of a group of instruments (Australian I, Australian II, German III, Hungarian I).

#### C 2.2.2 Sky functions

It is a century long effort to derive reliable (spectrally integrated) circumsolar sky functions. For clear atmosphere calculations can be made using aerosol models. In this respect Deirmendjian (1959), Frohlich and Quenzel (1974), Thomalla et al. (1983) and Putsay (1995) published results usable for pyrheliometric/diffusometric purposes. Their results are identical for identical aerosol conditions. The measurement of circumsolar radiation is more complicated than that of diffuse or direct solar radiation. Statistically significant amount of such measurements has only been made available in 1991 by the National Renewable Energy Laboratory (NREL), USA (Noring, Grether and Hunt). This database contains 170000 sky functions collected in eleven sites in the United States and cover a wide range of solar elevations and atmospheric conditions. The NREL kindly provided us with the data measured in April and May of 1977 at Boardman (Oregon). This dataset contains about 2000 functions of radiance distribution along the solar disc and the aureola up to 3.2° from the solar center.

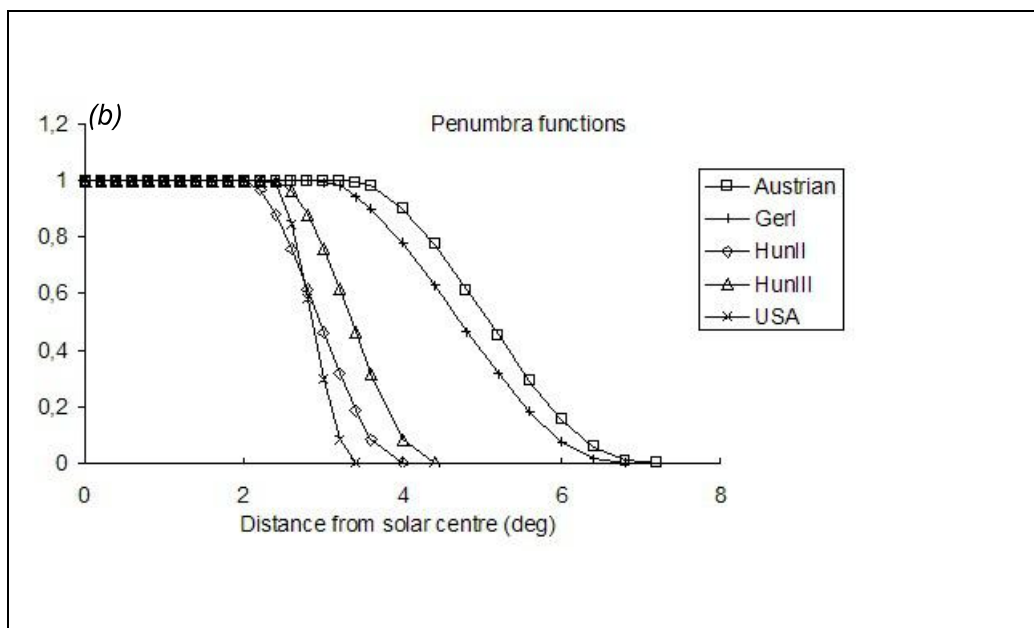
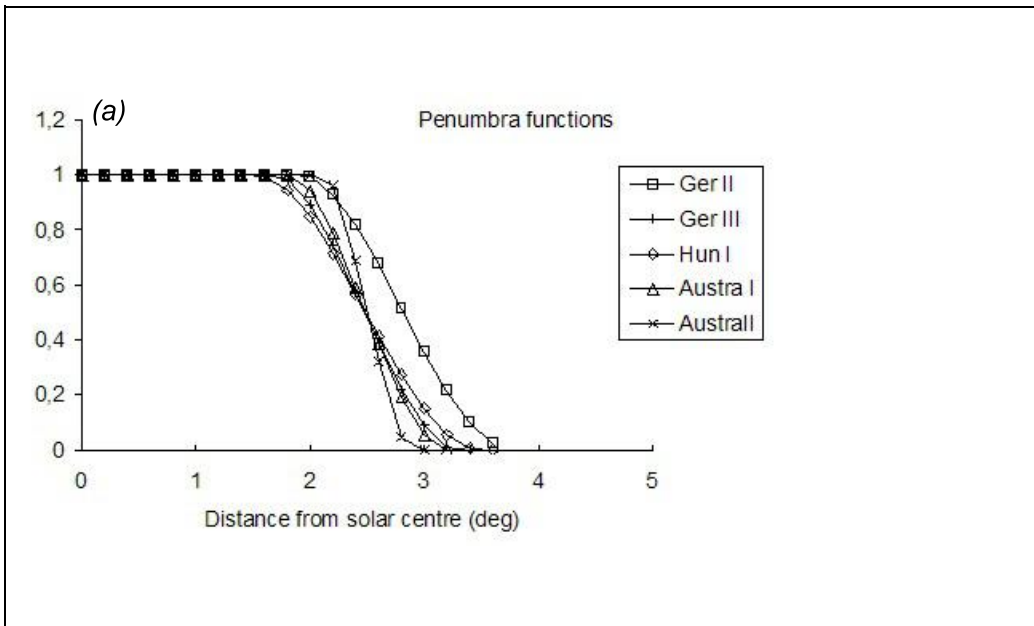

Figure C 2.1. Penumbra functions of diffusometers for 45 degrees solar elevation.

Comparing the calculated and measured sky functions it is seen, that the measured ones are much larger than the calculated ones. This is illustrated by Figure C 2.2 where the measured largest, smallest and mean function is seen altogether with ones calculated for different aerosol models, for 45 degrees solar elevation. All calculated functions are below the measured mean one. The variability of the calculated values is a factor of 5, while for the measured ones is about 10. The reason of difference between the calculated and measured values is that, that the real cloudless atmosphere usually contains haze particles too, while the model atmospheres are restricted to aerosol particles only. Figure C 2.3 shows the smallest, mean and largest measured functions together with ones calculated for atmosphere including haze particles too. Since the optical depth of haze contamination is very small, therefore the direct and diffuse radiation changes slightly, but the circumsolar radiation might vary by several times.

Summarizing the above mentioned results it should be stated, that the circumsolar radiation is a very variable parameter and it is almost independent of other characteristics (direct or diffuse radiation, optical depth) of the solar radiation field.

### C 2.2.3 Circumsolar diffuse irradiances

Let us suppose that the diffusometers listed in Table C 2.1 are at the same place and measure the diffuse radiation. Let us select a situation when the

- solar elevation is 45 degrees
- the direct radiation is  $700 \text{ W m}^{-2}$
- the diffuse radiation is  $160 \text{ W m}^{-2}$
- the circumsolar sky function is the mean of measurements (seen in Figs.C 2.2 or C 2.3).

Using the penumbra functions (Fig. C 2.1) of diffusometers, the calculated irradiance of their sensors seen in Table C 2.2a. For a more complete picture, in Table C 2.2b irradiances calculated for some pyrheliometers are shown. Since their slope angles are less than that of diffusometers, therefore the effect of circumsolar radiation on their output is less. More details regarding the pyrheliometers can be found in *Major (1995)*.

Four diffusometers from the ten "measure" identical value. It seems practical to declare these four instruments as "standard group" and to relate the output of the others to that of the standard group. Moreover, the standard group measures the highest value, so all the others have deficit compared

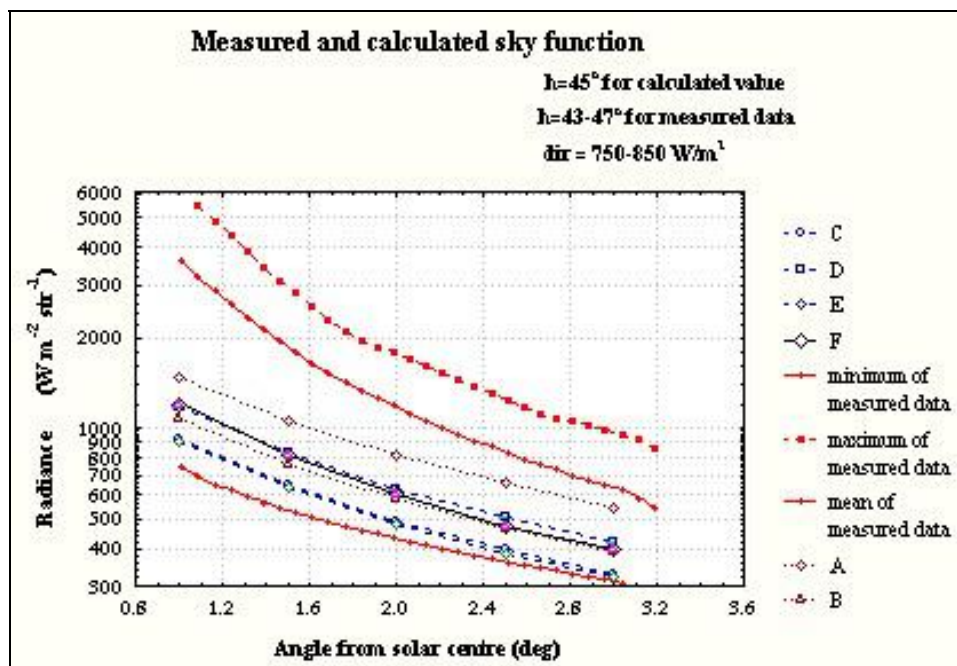

Figure C 2.2. Compared log measured and calculated circumsolar functions. Letters A, B, C, D, E, F symbolizes different aerosol models.

to the standard. In Table C 2.3 the values of deficit are shown for the diffusometers that are not in the standard group. Since the really measured deficit of Hungary III to Hungary I is collected for a long time and this way its variability with the conditions could be looked for, the deficits are normalized to that of HunIII. It is expected that the normalized deficit would not change with changing solar elevation and atmospheric conditions.

Diffusometer	Diffuse radiation from 0.5°	Circum 1 0.5° – 1.0°	Circum 2 1.0° - Z <sub>l</sub>	“Measured” value
Australia I	160	-3.11	-8.47	148.4
Australia II	160	-3.11	-8.51	148.4
Austria	160	-3.11	-16.90	140.0
Germany I	160	-3.11	-15.96	141.0
Germany II	160	-3.11	-9.90	147.0
Germany III	160	-3.11	-8.46	148.3
Hungary I	160	-3.11	-8.53	148.4
Hungary II	160	-3.11	-10.41	146.5
Hungary III	160	-3.11	-11.92	145.8
USA	160	-3.11	-10.03	146.9

Table C 2.2a. Diffusometer irradiances in  $W m^{-2}$ .

The radiation coming from the solar disk and from the belt up to 0.5 degree around it is excluded. The circumsolar radiance is divided into two parts.  $Z_l$  means the limit angle of the diffusometer.

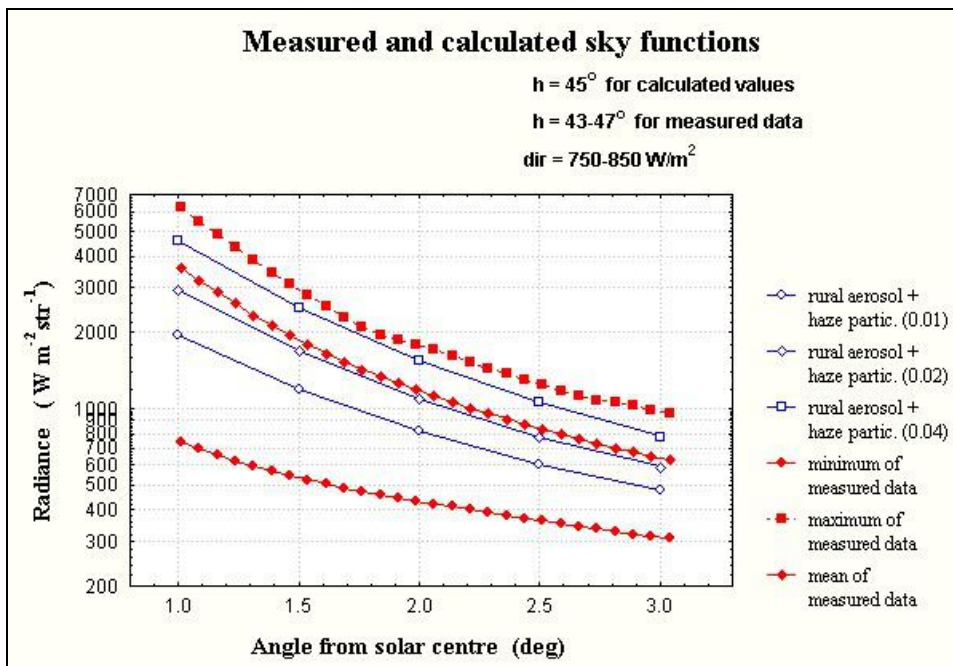

Figure C 2.3. Measured sky functions and their approximations by ones calculated for model atmosphere containing rural aerosol and haze particles.

### C 2.3 The measurement method

Between March of 1996 and August of 1997 three diffusometer of shading sphere were operated in Budapest using a SciTec solar tracker. Their characteristics are shown in Table C 2.1. The sampling of outputs were made at each 10 seconds, the stored data are 10 minutes averages. Due to different reasons, the operation was not continuous during the 18 months period, this way only the 60 percent of the possible daytime 10 minutes averages are available (cc. 33000 “readings”). The time series contain every kind of atmospheric conditions and solar elevation (up to 66 degrees) happened in that period. The data were processed in the year 2000 only.

Pyrheliometer	Direct radiation	Circum 1	Circum 2	“Measured”
CRO3	770	2.92	7.74	780.7
ABS	770	3.05	8.04	781.1
KIPP	770	3.11	8.65	781.8
NIP	770	3.11	10.92	784.0

Table C 2.2b. Pyrheliometer irradiances in  $W m^{-2}$

*CRO3 is the absolute pyrheliometer designed by D. Crommelynck. ABS is a group of absolute pyrheliometers (HF, PMO5, etc), KIPP and NIP are thermoelectric station pyrheliometers*

Instrument	Deficit percent	Deficit normalized to HunIII
Austria	6.1	2.54
Germany I	5.4	2.25
Germany III	1.0	0.42
Hungary II	1.3	0.54
Hungary III	2.4	1.00
USA	1.0	0,42

Table C 2.3. Comparison to the standard group.

There exists a group of diffusometers, the 4 members of the group give same diffuse radiation value according to the calculations, therefore it is suggested that this group could be regarded as geometrical standard of diffusometry.

#### C 2.3.1 Intercalibration of pyranometers

Kipp & Zonen CM5 pyranometers were used. Their intercalibration were made for each month. In overcast conditions the three diffusometers should provide the same value, since then the circumsolar effect is quite negligible. The ratio of HunI/HunII and of HunI/HunIII have different standard deviation, namely 0.011 and 0.006. This means that the “middle” pyranometer is more uncertain than the other two. This was recognized during the data processing, so the change of the uncertain pyranometer could not be made. It is lucky, that not the other pyranometers were problematic.

#### C 2.3.2 Dependence of ratios of measured diffuse radiation values on other parameters

For the whole data series the HunI/HunII and HunI/HunIII ratios had been calculated and their connection to other radiation measurements were looked for. A special “demonstration sample” of 50 observations has been selected to present here the relations. In this sample the cases of high direct radiation are over-represented.

Figure C 2.4 shows the connection between the ratio and the diffuse radiation itself. The upgoing part of the plot is the clear weather part. Figure C 2.5 shows the connections with the direct radiation. The highest ratios belong to the clearest atmospheric situations. The dependence on the diffuse per global ratio is seen in Figure C 2.6.

To estimate the deviation from the standard, the following type of equation is suggested:

$$RATIO_{HunIII} = a + b/(X-c)$$

Where a, b,c = regression parameters,  
X = either the direct radiation or the diffuse/global ratio.

For the direct radiation a = 0.98621  
b = - 14.9824  
c = 1086.5

For the diffuse/global ratio a = 0.99419  
b = 0.00537  
c = -0.07553.

## C 2.4 Reduction of measurements to standard geometry

The empirical formulae in section C 2.4.2 are valid for HunIII. Since

$$\text{RATIO}_{\text{HunIII}} = \text{HunI}/\text{HunIII} \sim \text{Standard}/\text{HunIII},$$

therefore the reduction of measurements of HunIII to standard geometry can be made by using any of the two formulae. The correction of other diffusometers are connected to that of HunIII in Table C 2.3 by the normalized deficit.

The normalized deficit of other diffusometers can be estimated by the following equation:

$$\text{DEFICIT}_{\text{NORM}} = a \cdot \text{SLOPE} + b \cdot \text{LIMIT} + c$$

where

$$\begin{aligned} a &= 0.425 \\ b &= 0.496 \\ c &= -2.270 \end{aligned}$$

These empirical constants derived from the data of the 10 instruments found in Tables C 2.1 and C 2.3. The correlation is 0.991. This way any diffusometer can be “placed “ into the last column of Table C 2.3 if its slope and limit angles have been calculated for “vertical position”. Since

$$1 + \text{DEFICIT} = \text{Standard}/\text{Diffuse}$$

where “Diffuse” = the output of the diffusometer so that the “Standard” value can be derived.

## C 2.5 Results

- (1) The following equipments have almost identical geometry: the two Australian diffusometers, the German BSRN station diffusometer and the SciTec-Kipp diffusometer, this way they could be regarded as a geometrically standard group of diffusometers.

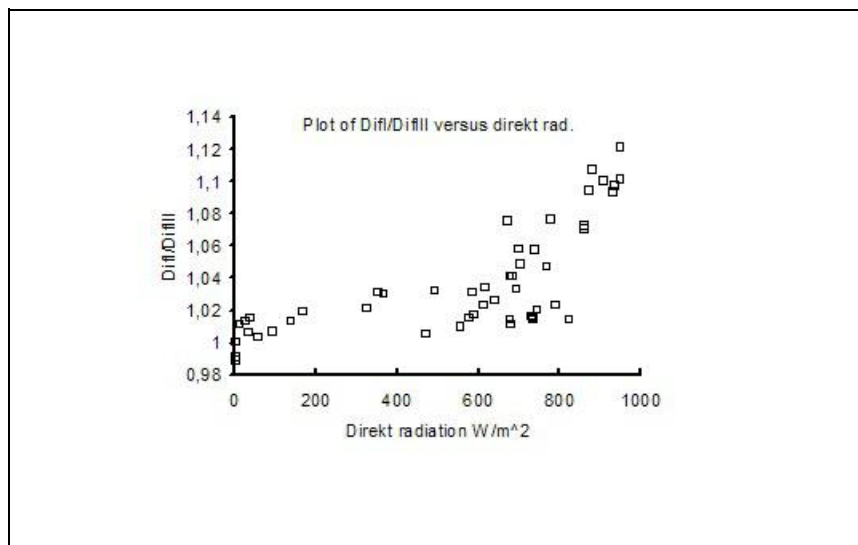

Figure C 2.5. Dependence of the HUNI/HUNIII on direct radiation.

- (2) The relation of the HunIII diffusometer to the standard (in practice to the SciTec-Kipp) is described by two empirical equations derived from 18 months measurements made in Budapest.
- (3) The relation of any diffusometer to HunIII is described by an other empirical equation (based on calculated circumsolar irradiances) that requires the radius of the shader, the radius of the sensor and the distance between them.

- (4) Using the empirical formulae mentioned in (1) and (2) the diffuse radiation measured by a diffusometer could be corrected to standard geometry.
- (5) Since the circumsolar sky radiation has high variability and it is almost independent from other radiation parameters, only the monthly (or at least several days) mean corrected diffuse radiation values could be expected as reliable.

## **C 2.6 Acknowledgements**

Thanks are due to those colleagues who provided the basic geometrical data of their equipment, namely: Klaus Dehne, John Hickey, Bruce Forgan, Ellis Dutton and Ernst Wessely.

## **C 2.7 References**

- Deirmendjian, D.: Theory of solar aureole. *Annales de Geophysique*. Part I: tome 13,1997; Part II: Tome 15, 1959.
- Frohlich, C and Quenzel, H.: Influence of the sun's aureole on the determination of turbidity. Special Environmental Report No. 3, WMO-No. 368, 1974.
- Major, G.: Estimation of the error caused by the circumsolar radiation when measuring global radiation as a sum of direct and diffuse radiation. *Solar Energy*, 48, No.4, 1992.
- Major G.: Circumsolar correction for pyrheliometers and diffusometers. WCRP, WMO/TD-No.635, 1994.
- Major, G.: The role of geometry in the comparison of standard pyrheliometers, *Idojaras*, 99, No.2, 1995.
- Noring, J.E., Grether, D.F. and Hunt, A.J.: Circumsolar radiation data: The Lawrence Berkeley Laboratory Reduced Data Base, NREL/TP-262-4429, 1991.
- Putsay, M.: Circumsolar radiation calculated for various aerosol models. *Idojaras*, 99, No.2, 1995.
- Thomalla, E., Kopke, P., Muller, H. and Quenzel, H.: Circumsolar radiation calculated for various atmospheric conditions. *Solar Energy* 30, 575-587, 1983.

### C 3. Annex 2 to the Diffuse Geometry WG Report: Optimization of Diffusometers to Pyrheliometers

Prepared by G. Major and M. Putsay, Hungarian Meteorological Service

#### C 3.1 Introduction

The instrument most commonly used to measure global radiation is the pyranometer. The sensitivity of pyranometers depend on several factors. To avoid several accuracy decreasing effects the following suggestion arises: measure the global radiation as sum of the diffuse radiation and of the vertical component of the direct radiation. The measured direct radiation always includes and the measured diffuse radiation always excludes some circumsolar radiation. To minimize the bias in the global radiation values, these two kind of circumsolar radiation should be as close to each other as is possible. The full equivalence can not be achieved (*Major 1992*). In this work geometrical parameters of diffusometers are derived to fit them to some selected pyrheliometers.

#### C 3.2 Basic considerations

The direct + diffuse method of measuring of global radiation is based on the following equation:

$$G = I \sin(h) + D \quad (1)$$

where  $I$  = the direct radiation coming from the solar disc,

$h$  = the solar elevation angle,

$D$  = the diffuse radiation, defined by (1).

The pyrheliometer measured direct radiation:

$$I_p = I + C_{dir} \quad (2)$$

where  $C_{dir}$  = the circumsolar radiation received by the pyrheliometric sensor.

The diffusometer measured diffuse radiation:

$$D_d = G - (I + C_{dif}) \sin(h) \quad (3)$$

where  $C_{dif}$  = the circumsolar radiation excluded by the diffusometer.

Our purpose is the minimization of the following difference:

$$DE = G - (D_d + I_p \sin(h)) = \sin(h) (C_{dif} - C_{dir}) \quad (4)$$

Taking into account the formulae of calculating the circumsolar radiation (*Major 1994, p. 34*), the difference is:

$$DE = \sin(h) \pi \int L(z) \sin(2z) (F_{dif} - F_{pyr}) dz, \quad (5)$$

where  $z$  = the angle measured from the solar center,  
the  $\int$  extends from the smaller of the slope angles to the larger of the limit angles of the two instruments,

$L(z)$  = the radiance distribution along the circumsolar sky (sky function),

$F(z)$  = the penumbra function for the diffusometer and pyrheliometer respectively.

For any pyrheliometer  $F_{pyr}$  is a definite function of its geometry, while in the case of diffusometers  $F_{dif}$  is a function of the geometry and of the solar elevation as well.  $L(z) \sin(2z)$  plays the role of a weighting function in integrating the difference of the penumbra functions. It weights the "circumstances" of the

measurement, namely the atmospheric conditions (scattering) and the solar elevation. For a given pyrheliometer and given circumstances several such diffusometers could be composed that would result in zero DE. For a given pyrheliometer + diffusometer system, DE varies with varying circumstances. To obtain small DE values in each condition, the two penumbra functions should be as close to each other as possible. The construction of a diffusometer that (together with the pyrheliometer) gives yearly zero-bias global radiation, requires that the yearly combined probability distribution of:

1. solar elevation,
2. turbidity (scattering),
3. diffuse radiation,
4. sunshine

be taken into account when minimizing the standard deviation of DE around its zero mean.

### Examples

The above considerations will be applied for:

1. a very wide range of sky functions,
2. 20, 45 and 60 degrees of solar elevation,
3. geometrically different pyrheliometers,
4. pyranometers used in radiation stations

to find the diameter of shading disk and the length of arm that diffusometers require for optimal performance.

#### C 3.2.1 Sky functions

The sky functions (only cloudless atmosphere is considered) depend on:

1. the type and amount of atmospheric aerosol,
2. the humidity (size distribution of aerosol and appearance of haze particles),
3. the solar elevation angle (optical path length).

For the least scattered radiation, a mountain aerosol model was used with an optical depth of 0.05. The middle conditions are represented by continental aerosol with an optical depth of 0.23. Also for these conditions a measured sky function is used. It is a mean of circumsolar measurements made in Boardman (USA) at 45 degrees solar elevation. This function is quite close to the one calculated for rural aerosol plus haze particles with an optical depth of 0.02. The radiation flux with the greatest scattering is represented by a summertime desert aerosol of 1.0 optical depth. For desert conditions there have been reports of optical depth as high as 4, but even in the case of 1 optical depth, direct radiation hardly could be measured. Table C 3.1 provides the direct beam irradiance for each of the model and solar elevation combinations.

The calculation of the sky functions has been made by M. Putsay.

Solar elevation (deg)	Mountain aerosol	Continental aerosol	Summer desert aerosol	Measured
60	1041	863	343	
45	983	785	253	770
20	727	470	45	

Table C 3.1. Direct radiation ( $W m^{-2}$ ) for the 10 sky functions.

### C 3.2.2 The pyrhemometers and pyranometers

For several pyrhemometers the basic geometric data can be found in (*Major 1995*). From these, three instruments have been selected that:

- (1) can operate continuously at radiation stations,
- (2) cover a relatively wide range of slope angles.

The Hickey-Frieden pyrhemometer (H-F) is a cavity type with a slope angle of 0.78 deg. The Kipp and Zonen CH-1 has a flat thermopile sensor. Its slope angle is 1 deg. The Eppley Inc. NIP is a wide angle (its slope angle is 1.78 deg) thermopile pyrhemometer. The geometry of the diffusometers will be fitted to these pyrhemometers.

It is seen from Table C 3.2 that these pyrhemometers receive different scattered radiation from the same sky. It is also seen that the sky function has a wide range of variation. The part of the sky nearer to the sun than 0.8 degrees has not been included into the calculations since the smallest slope angle of the involved instruments is 0.78 deg.

<b>Sky function</b>	<b>H-F</b>	<b>CH-1</b>	<b>NIP</b>
Mountain 60	1.83	1.92	2.54
45	2.11	2.22	2.93
20	3.18	3.34	4.42
Continental 60	2.67	2.82	3.54
45	2.95	3.12	3.92
20	3.59	3.78	4.75
Desert 60	30.2	31.9	40.2
45	27.2	28.7	36.2
20	9.78	10.3	13.0
Measured 45	8.62	9.13	11.3

Table C 3.2. Circumsolar irradiances ( $W m^{-2}$ ) on the pyrhemometric sensors from the part of the sky,  $z > 0.8$  deg.

At the BSRN stations Kipp & Zonen CM-11 / CM-21 or Eppley PSP pyranometers are used normally. To avoid the problem of zero deflection (sometimes known as nighttime offset), B&W instruments are being considered for the measurement of diffuse irradiance. The sensing surface is circular for each type. Table C 3.3 gives the sensor radius and diameter of the outer glass dome for each of the instruments considered in this study. Thanks are due to Mr. John Hickey (EPPLAB) and Mr. Leo van Wely (Kipp and Zonen) for providing detailed descriptions of their pyranometers.

### C 3.2.3 Existing diffusometers

For investigating the circumsolar effect, some BSRN station scientists provided the diameter of the shading disk/sphere and the arm length (distance between the pyranometer and the shading device) of their diffusometers. Each station has its individual preference, however most of the full opening angles are  $5^\circ$ , exceptions being the North American devices that match the Eppley NIP; their opening angle is  $5.8^\circ$ .

<b>Instrument</b>	<b>Type</b>	<b>Sensor's radius, mm</b>	<b>Diameter of glass dome, mm</b>
EPPLEY PSP	Black	5.64	50
KIPP CM-11 and CM21	Black	10	50
EPPLEY 8-48	B&W	16	50
SCHENK Star	B&W	16	65

Table C 3.3. Pyranometer characteristics.

As a first step, the arm length values of the diffusometers were varied. Equation (5) gives a DE value for each sky function and for each pyrhemometer-diffusometer system. The optimal arm length of a system is that for which the mean of the DE values derived for the 10 sky functions is zero, this way

the diffusometer has been fitted to the pyr heliometer. Table C 3.4 provides information on the original length of the diffusometer arm and the optimal arm-length fitted for the pyr heliometers used for these calculations.

The measures of fit are:

- (1) the standard deviation
- (2) and the maximal absolute value of DE.

<b>Diffusometer</b>	<b>Fitted to HF</b>	<b>Fitted to CH-1</b>	<b>Fitted to NIP</b>	<b>Original</b>
Austral CM	885	785	695	795
German CM	790	690	595	687
SciTec CM	630	600	505	577
Canadian CM	940	910	730	750
Austral PSP	885	820	700	795
USA PSP	845	745	580	603

Table C 3.4. Original and “optimal” arm length values (m m) for existing BSRN diffusometers.

The second step was the variation of the radii of shading devices. These results are given in Table C 3.5.

<b>Diffusometer</b>	<b>Fitted to HF</b>	<b>Fitted to CH-1</b>	<b>Fitted to NIP</b>	<b>Original</b>
Austral CM	31	34	39	34.8
German CM	27.3	29	34.5	30
SciTec CM	23.7	24	29	25.4
Canadian CM	29.5	31.7	37.5	37.5
Austral PSP	29	33	39	34.8
USA PSP	24.3	27	37.5	37.5

Table C 3.5. Values of original and “optimal” radii (m m) of shading disk or sphere for the existing BSRN diffusometers.

#### C 3.2.4 Optimal systems

The third step was to look for the arm length and shader radius for each *pyranometer – pyr heliometer pair* that gives the best possible fit. Since the full glass dome must be shaded (this is the common sense feeling contrary to the statement made by Kees van den Bos of Kipp & Zonen at the 1998 Budapest BSRN Workshop), therefore the shading disk/sphere must be a little larger than the glass dome. For three pyranometers (the exception is the Eppley 8-48) the lower limit value of the shading disk/sphere is the optimal one (Table C 3.6).

- (1) In the case of optimized arm lengths or shading disks/spheres (let us say half optimization) the bias is zero, the mean standard deviation is  $0.5 \text{ W m}^{-2}$ , the maximal difference is  $1 \text{ W m}^{-2}$ .
- (2) For the fully optimized pairs the mean (for the 12 pairs) of standard deviations is  $0.2 \text{ W m}^{-2}$ , the maximal difference is  $0.5 \text{ W m}^{-2}$ .
- (3) The NIP fits best to each pyranometer having one third of the values mentioned in the previous conclusion. The weakest of the NIP’s fit is to the PSP, this is due to the large dome size – sensor size ratio at PSP.
- (4) The 8-48 could be fitted best to any pyr heliometer, since its dome is only slightly larger than its sensor.
- (5) It is suggested to make individual optimization for each station (solar elevation, aerosol, radiation and sunshine conditions) taking into account the available instrumentation (pyranometer, pyr heliometer, tracker). This way the best fit could be achieved within the available financial possibilities and the actual differences can be determined for the system to be realized.

Pyranometer	Radius of shading disk/sphere	Arm length to fit to HF	Arm length to fit to CH-1	Arm length to fit to NIP
CM 11 or 21	25.4	630	603	505
EPPLEY PSP	25.4	635	605	510
EPPLEY 8-48	30	726	703	574
SCHENK Star	34	840	815	668

Table C 3.6. Optimal geometric parameters (mm) of diffusometer for the considered pyranometer- pyrliometer pairs.

### C 3.3 References

Major, G. 1992: Estimation of the Error Caused by the Circumsolar Radiation when Measuring Global Radiation as a sum of Direct and Diffuse Radiation. *Solar Energy*, 48.

Major, G. 1994: Circumsolar Correction for Pyrliometers and Diffusometers. WMO/TD-No. 635

Major, G. 1995: The role of geometry in the comparison of standard Pyrliometers. *Idojaras*, 99, No. 2.

**C 4. Annex 3 to Diffuse Geometry WG Report: Examination of shading mechanisms for diffuse sky irradiance measurement for use in the BSRN**

Prepared by: Atsumu Ohmura, Institute for Atmosphere and Climatic Science, Swiss Federal Institute of Technology (ETH)

**C 4.1 Introduction**

The uncertainty of the effect of the shading mechanism for diffuse sky irradiance observation compelled the BSRN to form a working group, which will examine the effect of the shading on the irradiance measurement and recommend the most suited mechanism for the BSRN standard. The core question is how a mechanism can be designed to observe the same irradiance in diffuse radiation which is also measured by the standard pyrheliometers under variety of atmospheric conditions. Major (1994) sought for the best geometrical structure for the diffusometer conceived around the Kipp CM-11 pyranometer and concluded that it is possible to keep the maximum difference in diffuse radiation received by the pyrheliometer and diffusometers within  $0.8 \text{ W m}^{-2}$ . This study shows, however, a consistently larger diffuse radiation blacked by the Kipp shading mechanism. From the fundamental difference in the geometrical structures between pyrheliometers and diffusometers based on pyranometers with a shading mechanism, exact symmetry is not possible. It is therefore desirable to find the best geometrical combination which provides the unbiased shading with smallest possible maximum deviations. As a pyrheliometer, the generic form of the seven absolute cavity radiometers of the World Standard Group is considered. Various sky functions as recently compiled by Major et al. (2000) are reproduced in Figure C 4.1. As the sky function, the interpolated radiance among the observations was taken, which

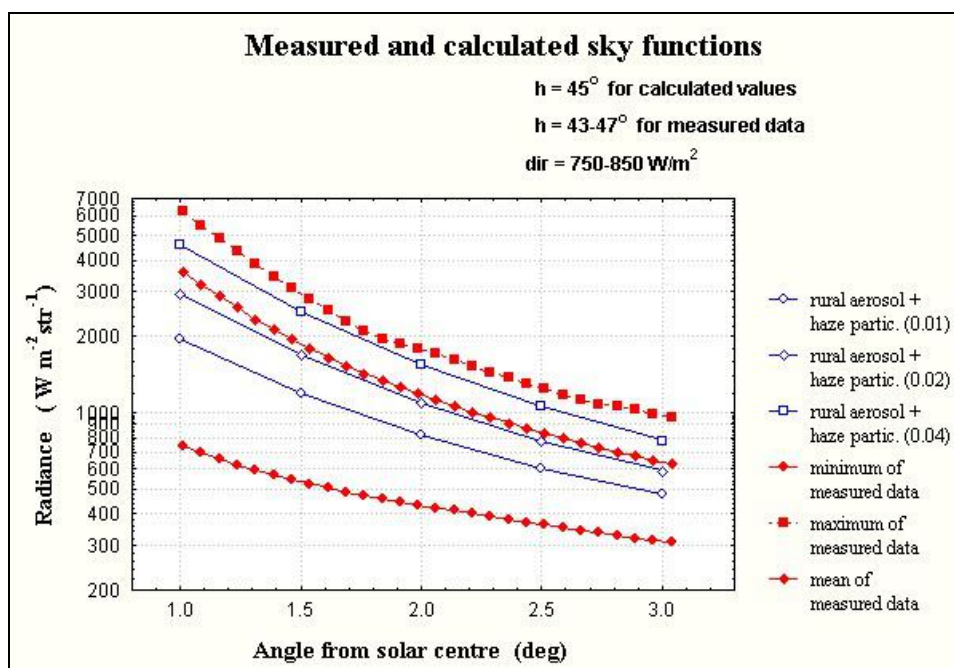

Figure C 4.1. Measured sky functions and their approximations by ones calculated for model atmosphere containing rural aerosol and haze particles too (courtesy of Major, 2001).

approximates the mean observed irradiance and yields total irradiance of  $1000 \text{ W m}^{-2}$  for the angle between  $1^\circ$  and  $4^\circ$  measured from the centre of the sun.

**C 4.2 Irradiance in the instrument: Numerical solutions**

Since the relationship between the radiation and the sensor continuously changes with the solar zenith angle, exact comparability happens only when the sun is at zenith. This rare occasion nevertheless is useful to develop the general case for which most measurements are carried out.

**C 4.3 Sun at zenith**

The geometrical condition between radiance and an instrument is illustrated in Figure C 4.2 for the sun at zenith. The same figure represents both pyrheliometers and diffusometers by swiching the frontal circle between the opening and the shading disc (or sphere). We consider a point on the sensor which is located at a distance of  $r'$  measured from the sensor centre. Radiance at this point falls at a zenith angle of  $z'$ . We consider total irradiance  $F_r$  at this point coming into the instrument (or blocked by the shading disc). This calculation involves a double integration, one from the normal to the sensor to the edge of the opening (or disc) whose angle to the normal is  $z$ , the other from  $0^\circ$  to  $360^\circ$  in azimuth:

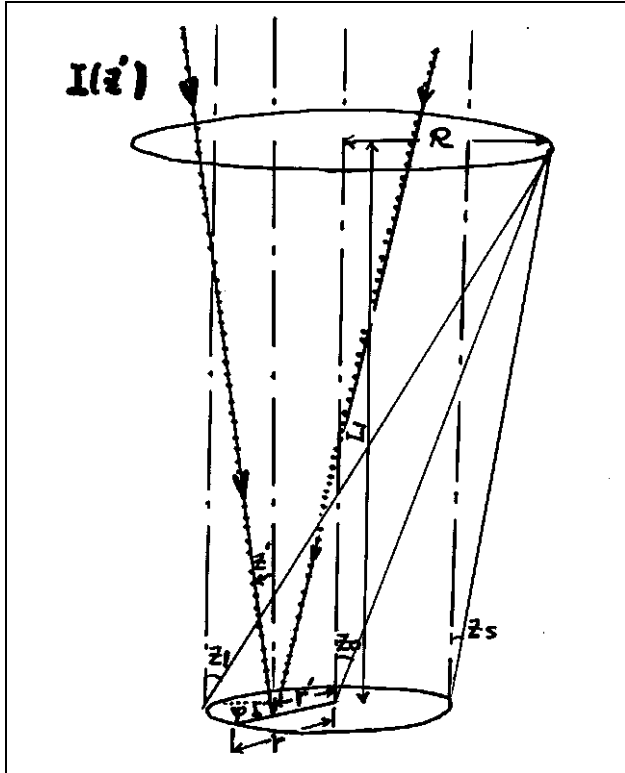

Figure C 4.2. Relationship between the geometry of pyrheliometers and radiance (The relationship applies for a diffusometer when the sun is at zenith).

$$F_{r'} = \frac{1}{2} \int_0^{2\pi} \int_0^z I(z') \sin 2z' dz' d\phi,$$

where

$$z = \frac{\sqrt{R^2 + r'^2 - 2Rr' \cos \phi}}{L}.$$

This irradiance  $F_r$  expected at  $r'$  on the sensor must be integrated for the entire sensor surface to obtain the absolute amount of radiative flux (or the amount blocked by the shading disc):

$$F = \int_0^{2\pi} \int_0^r F_{r'} r' dr' d\phi,$$

where  $r =$  the radius of the sensor.

This radiative flux can be converted for a unit area to obtain the irradiance expressed in the conventional unit.

$$F_s = \frac{F}{\pi r^2}.$$

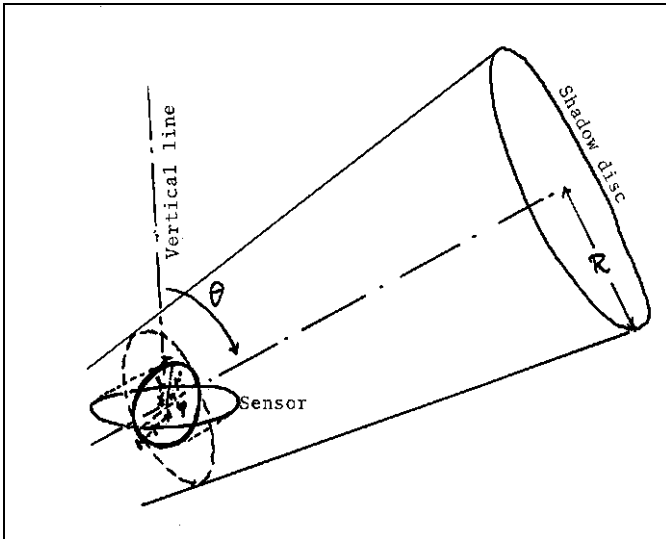

Figure C 4.3a. Relationship between the shadow disc and the sensor of a pyranometer.

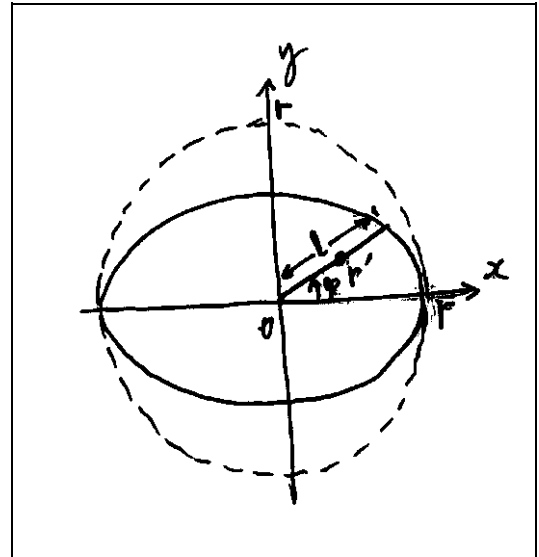

Figure C 4.3b. Detail of the sensor projection on to the normal plane parallel to the shadow disc.

#### C 4.4 Sun at an arbitrary zenith angle

The relationship between a pyranometer sensor and the shading disc is illustrated in Figure C 4.3a. The details on the geometrical situation on and near the sensor is presented in Figure C 4.3b. In this case the irradiance  $F_r$  at  $r'$  on the projected surface must be integrated for the surface of the ellipse which is projected on the plane normal to the direction of the sun. The solar zenith angle is designated to be  $\theta$ , then the distance from the centre of the ellipse to its edge  $l$  will be expressed as:

$$l = \frac{r \cos \theta}{\sqrt{1 - \sin^2 \theta \cos^2 \varphi}}.$$

Then the absolute amount of radiative flux for the entire surface will be,

$$F = \int_0^{2\pi} \int_0^l F_r r' dr' d\varphi.$$

The irradiance for the unit sensor surface on a horizontal surface will become

$$F_s = \frac{F}{\pi r^2}.$$

The results of the computation of irradiance for the standard pyrheliometer and various diffusometers are presented in Table C 4.1. From this result it can be concluded that most diffusometers used in the BSRN show less than  $3 \text{ W m}^{-2}$  influence. The best proposal is presented in the second right hand column in the table.

Pyrheliometer and Diffuse Geometry Configurations					
	ACR or Kipp & Zonen CH1	Kipp & Zonen 2AP Tracker with CM series pyranometer	Eppley SDK	BSRN with Eppley 8-48 B/W with similarity to ACR	BSRN with Kipp & Zonen CM Series pyranometer with 2000 design
Instrument Characteristics					
R (mm)	8	25.4	30	28	28
r (mm)	4.8	10.4	15.8	15.8	10.4
L (mm)	183	577	600	641	750
z <sub>i</sub> (°)	4	3.5	4.4	3.9	2.9
z <sub>o</sub> (°)	2.5	2.5	2.9	2.5	2.1
z <sub>s</sub> (°)	1	1.5	1.4	1.1	1.3
Sky irradiances expected from 0° to z <sub>l</sub> from the centre of the sun under various solar zenith angles (W m <sup>-2</sup> )					
0°	2.9	12.8	14.4	12.9	11.2
30°	11.1	11.1	12.4	11.1	9.7
60°	6.3	6.3	7	6.3	5.6

Table C 4.1. Sky irradiances expected from 0° to z<sub>l</sub> from the centre of the sun under various solar zenith angles (W m<sup>-2</sup>).

#### C 4.5 Analytical solutions

Since there is not much a problem to assume a mean radiance for the range of 1° to 4° for z', the above consideration can be solved analytically. The both ends on the angle range correspond sloping and limiting angles, respectively. An advantage of an analytical consideration is a possibility to be able to follow the entire process in one equation. Exercises of this kind often provide us an insight into a new idea. The mean value for I(z') is designated as  $\overline{I(z')}$ .

For the sun at the zenith or for pyrheliometers,

$$F_{r'} = \frac{1}{2} \overline{I(z')} \int_0^{2\pi} \int_0^z \sin 2z' dz' d\phi = \frac{\overline{I(z')}}{4} \int_0^{2\pi} (1 - \cos 2z) d\phi,$$

where

$$z = \frac{\sqrt{R^2 + r'^2 - 2Rr' \cos \phi}}{L}.$$

Since z can not exceed the limiting angle and therefore, is very small, approximating the cosine function with the polynomial development, it suffices to take the first two terms, and then

$$\begin{aligned} F_{r'} &= \frac{\overline{I(z')}}{4} \int_0^{2\pi} 2z^2 d\phi = \frac{\overline{I(z')}}{2} \int_0^{2\pi} \frac{R^2 + r'^2 - 2Rr' \cos \phi}{L^2} d\phi, \\ &= \frac{\pi \overline{I(z')}}{L^2} (R^2 + r'^2). \end{aligned}$$

The integration of  $F r'$  for the entire sensor surface gives,

$$F = \frac{\pi \overline{I(z')}}{L^2} \int_0^{2\pi} \int_0^r (R^2 + r'^2) r' dr' d\varphi = \frac{\pi^2 r^2 \overline{I(z')}}{L^2} \left( R^2 + \frac{r^2}{2} \right).$$

Then,

$$F_S = \frac{\pi l \overline{I(z')}}{L^2} (R^2 + r'^2)$$

Likewise for the sun at an arbitrary zenith angle  $\theta$ , we obtain the followings:

$$F = \frac{\pi \overline{I(z')}}{L^2} \int_0^{2\pi} \int_0^l (R^2 + r'^2) r' dr' d\varphi,$$

where

$$l = \frac{r \cos \theta}{\sqrt{1 - \sin^2 \theta \cos^2 \varphi}}.$$

Then further,

$$\begin{aligned} F &= \frac{2\pi \overline{I(z')}}{L^2} \left[ R^2 r^2 \cos^2 \theta \int_0^{\pi/2} \frac{d\varphi}{1 - \sin^2 \theta \cos^2 \varphi} + \frac{r^4 \cos^4 \theta}{2} \int_0^{\pi/2} \frac{d\varphi}{(1 - \sin^2 \theta \cos^2 \varphi)^2} \right] \\ &= \frac{2\pi \overline{I(z')}}{L^2} \left\{ R^2 r^2 \cos^2 \theta \left[ \frac{1}{\sqrt{1 - \sin^2 \theta}} \arctan \frac{\tan \varphi}{\sqrt{1 - \sin^2 \theta}} \right]_0^{\pi/2} + \frac{r^4 \cos^4 \theta}{2} \int_0^{\pi/2} \frac{d\varphi}{(1 - \sin^2 \theta \cos^2 \varphi)^2} \right\} \\ &= \frac{2\pi \overline{I(z')}}{L^2} \left( R^2 r^2 \cos^2 \theta \frac{\pi/2}{\cos \theta} + \frac{r^4 \cos^4 \theta}{2} \frac{\pi}{2} \frac{1 + \cos^2 \theta}{2 \cos^2 \theta} \right) \\ &= \frac{\pi^2 r^2 \overline{I(z')}}{L^2} \cos \theta \left[ R^2 + \frac{r^2 \cos \theta (1 + \cos^2 \theta)}{4} \right]. \end{aligned}$$

For the unit area,

$$F_S = \frac{\pi \overline{I(z')} \cos \theta}{L^2} \left[ R^2 + \frac{r^2 \cos \theta (1 + \cos^2 \theta)}{4} \right].$$

Since the irradiance on the surface by a pyrliometer adjusted for the horizontal surface  $F_{ph}$  is

$$F_{ph} = \frac{\pi \overline{I(z')} R^2 \cos \theta}{L^2} \left[ 1 + \frac{1}{2} \left( \frac{r}{R} \right)^2 \right],$$

the following relation must be kept,

$$\left( \frac{R}{L} \right)^2 \left[ 1 + \frac{1}{2} \left( \frac{r}{R} \right)^2 \right] = \left( \frac{R_d}{L_d} \right)^2 \left[ 1 + \frac{\cos \theta (1 + \cos^2 \theta)}{4} \left( \frac{r_d}{R_d} \right)^2 \right],$$

where the subscript d stands for the variable for the diffusometer.

This last equation shows two important aspects concerning the geometry of the diffusometer.

- (1) In principle it is important to keep  $R/L=R_d/L_d$  and  $r/R=r_d/R_d$ ,
- (2) Since it is not practical to change geometrical dimensions of the involved parts, it is a practically better solution to adjust geometry for representative solar zenith angle. The earth's equivalent solar zenith angle of  $53^\circ$ , can be regarded as a working angle. Therefore,  $R_d/L_d$  which is slightly larger than  $R/L$ , or  $r_d/R_d$  which is slightly larger than  $r/R$  suits the best for the present requirement. Since the latter possibility is difficult to fulfil due to a relatively large difference in radii between the sensor and the outer glass dome, the best solution can be obtained by adjusting  $R_d/L_d$ , by making  $L_d$  smaller than the designated length which is calculated based a perfect symmetry requirement.

#### C 4.6 Conclusion

Most diffusometers adopted by the BSRN stations are capable of keeping the errors induced by the shadow effect within  $2$  to  $3 \text{ W m}^{-2}$ . The best recommended diffusometer is to use Eppley B/W pyranometer 8-48, with the shading disc radius of  $28.0 \text{ mm}$  and the arm's length of  $641 \text{ mm}$ .

#### C 4.7 References

- Major, G., 1994: Circumsolar correction for pyrliometers and diffusometers. WMO/TD-No.635, 42 pp.
- Major, G., Nagy, Z., and Putsay, M., 2000: The effect of diffusometer shading geometry. Report for the BSRN Meeting, May 1-5, 2000, Melbourne, 8 pp.

## Annex D Pyrheliometers and Pointing

### D 1. On the Pointing Error of Pyrheliometers

Prepared by G. Major for the BSRN discussion held in Davos, Switzerland, in October of 1995

#### D 1.1 Introduction

The direct radiation is the solar radiation coming from the solid angle determined by the solar disk. The pyrheliometers are designed to measure the direct radiation. Their view limiting angles (slope, opening and limit angle) are larger than the visible radius of the solar disk. This is partly due for the easier tracking of the Sun: if the limiting angles are larger than the solar disk, it is not necessary to follow the Sun quite precisely.

How large pointing errors or inaccuracies occur in the everyday practice? Let us take a hand-operated pyrheliometer. If its adjustments are made once in a minute, its largest mispointing in azimuth angle would be one quarter of a degree. The deviation from the right position in elevation angle is in the same order. Regarding the pointing devices of the pyrheliometers, 1 mm deviation of the illuminated spot from its proper position could be regarded as large mispointing. Depending on the length of the pointing path, this deviation means about half a degree of pointing error.

The purpose of this document is to present calculated values of the errors in the output of pyrheliometers caused by pointing uncertainty up to 2 degrees. Two atmospheric conditions are taken into account:

-- mountain aerosol, optical depth: 0.07, solar elevation: 60 degrees, direct radiation: 1000 W m<sup>-2</sup>;

-- continental background aerosol, optical depth: 0.23, solar elevation: 20 degrees, direct radiation: 461 W m<sup>-2</sup>.

The calculations have been made for 3 pyrheliometers: the PacRad size cavity instrument (ABS), the KIPP and NIP pyrheliometers. Their slope angles are: 0.75, 1.0 and 1.78 degrees respectively.

#### D 1.2 The method of calculation

The calculation is based on the Pastiels' theory (see for example in Major 1994). The irradiance given by a circular pyrheliometer can be written as:

$$I = \frac{V}{KS} = \pi \int_0^{z_i} F(z) L(z) \sin(2z) dz$$

where  $V$  = the output of the pyrheliometer,  
 $K$  = the average sensitivity of the receiver,  
 $S$  = the area of the receiver,  
 $z_i$  = the limit angle of the pyrheliometer,  
 $F(z)$  = the penumbra function of the pyrheliometer,  
 $L(z)$  = the radiance (=sky function)  
 $z$  = the angle between the direction of radiance and the optical axis of the pyrheliometer.

Circular pyrheliometer means that all the view limiting diaphragms and the receiver are circular in shape, that is the whole pyrheliometer has a rotational symmetry around its optical axis. In the equation the same rotational symmetry is supposed for the solar disk and the circumsolar sky.

If the optical axis of the pyrhelimeter is not directed to the solar centre, than the angle measured from the solar centre ( $z_1$ ) differs from the angle measured from the optical axis ( $z$ ). The transformation:

$$\cos(z_1) = \cos(d) \cos(z) + \sin(d) \sin(z) \cos(\varphi),$$

where  $d$  = the deviation between the solar centre and the optical axis, that is the pointing error,  
 $\varphi$  = an azimuth angle measured in the plane of the receiver, it is zero if the radiance comes from the solar centre.

#### D 1.2.1 Radiance along the solar disk

Photospheric models of the Sun produce one-dimensional radiance distribution across the solar disk, that is the so called limb darkening function. According to theoretical calculations (Allen 1985, Zirin 1988) the radiance depends near linearly on the cosine of the zenith angle at the solar "surface". Taking into account some observations too (Zirin 1988) and using  $z_1$  as variable instead of the aforementioned zenith angle, the following radiance distribution along the solar disk has been used:

$$L(z_1) = L_0 (0.3 + 0.7 \text{SQR}(1-(z_1/0.26)^2))$$

where  $L_0$  = the radiance at the solar centre,  
 $0.26$  = the radius of the solar disk in degrees.

This way the atmosphere affects the absolute value of the radiance coming from the solar disk, but not the relative distribution along it. If the direct radiation is  $1000 \text{ W m}^{-2}$ , then  $L_0 = 2.01565 \cdot 10^7 \text{ W (m}^2 \cdot \text{sr)}^{-1}$ , while at  $461 \text{ W m}^{-2}$  it is  $9.29216 \cdot 10^6$ . Since the gradient at the solar edge is very large, the integration step for the calculation of irradiance received by a pyrhelimeter has to be  $0.0001$  degree to obtain  $0.1 \text{ W m}^{-2}$  accuracy.

#### D 1.2.2 Radiance along the circumsolar sky

For several atmospheric aerosol content and solar elevation angle the radiances coming from the circumsolar sky have been calculated by Putsay (1995). To make our calculation more practical, second order polynoms have been fitted to the logarithm of the two selected circumsolar sky function. The fit is not quite perfect, but it is not significant since we want to obtain the effect of the shift caused by the uncertain pointing.

On Figure D 1.1 the whole (solar and circumsolar) sky functions are shown for the two selected atmospheric models.

#### D 1.2.3 The penumbra functions

To make the computations faster, the penumbra functions have been approximated by third order polynoms in the interval between the slope and limit angles. Again, the fit is not perfect, but this has small effect on the deviations of the values calculated for different pointing uncertainty.

### D 1.3 Results

In the calculations the effect of the solar disk and that of the circumsolar sky could be separated. On Figure D 1.2 and D 1.3 the actually direct irradiance of the pyrhelimetric sensor can be seen. If the pointing error is smaller than the slope angle, the irradiance is not affected. If the solar disk is in the penumbra region of the pyrhelimeter, the irradiance decreases rapidly with the increasing pointing error.

On Figure D 1.4 the irradiance coming from the circumsolar sky is seen for all pyrhelimeters and for both atmospheric conditions. The decrease is continuous but the effect is not significant compared to that of the solar disk.

### D 1.4 Conclusions

- (1) If the pointing error of a pyrhelimeter is smaller than its slope angle, the effect is negligible.

- (2) If the pointing error of a pyrheliometer is larger than its slope angle, the irradiance of the pyrheliometric sensor decreases rapidly with increasing mispointing. The value can be estimated using Fig. C1.2 and Fig. 1.3.

#### **D 1.5 References**

Allen, C.W. 1985: *Astrophysical Quantities*. The Athlone Press, London.

Major, G. 1995: *Circumsolar Correction for Pyrheliometers and Diffusometers*. WCRP, WMO/TD-No.635

Putsay, M. 1995: *Circumsolar Radiation Calculated for Various Aerosol Models*. IDŐJÁRÁS, vol 99, pp 67-76.

Zirin, H. 1988: *Astrophysics of the Sun*. Cambridge University Press, Cambridge-New York-London-New Rochelle-Melbourne-Sydney.

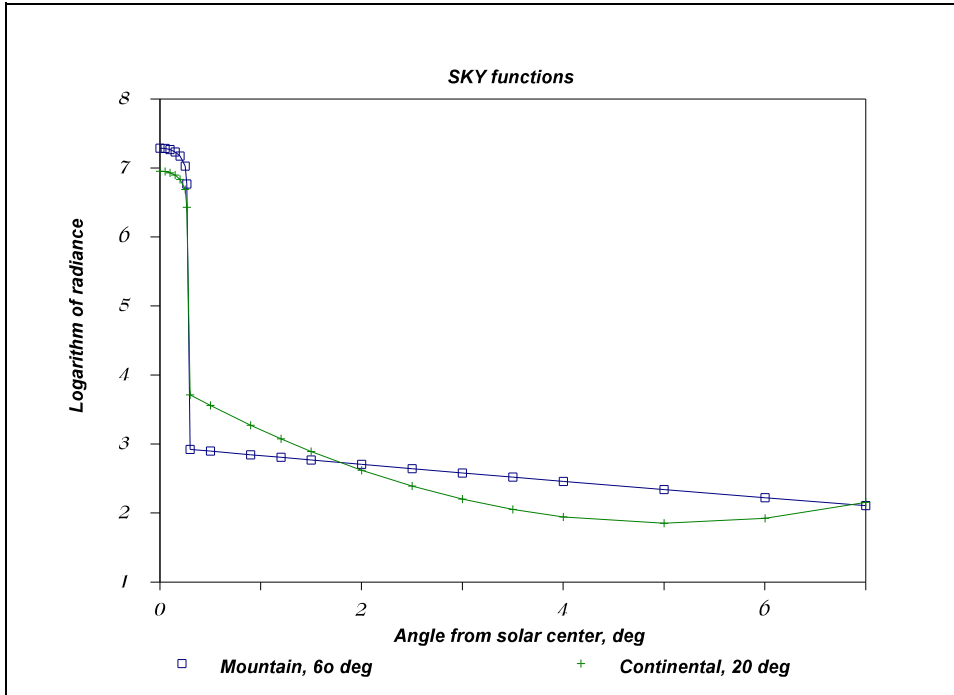

Figure D 1.1. The sky functions used in this calculation.

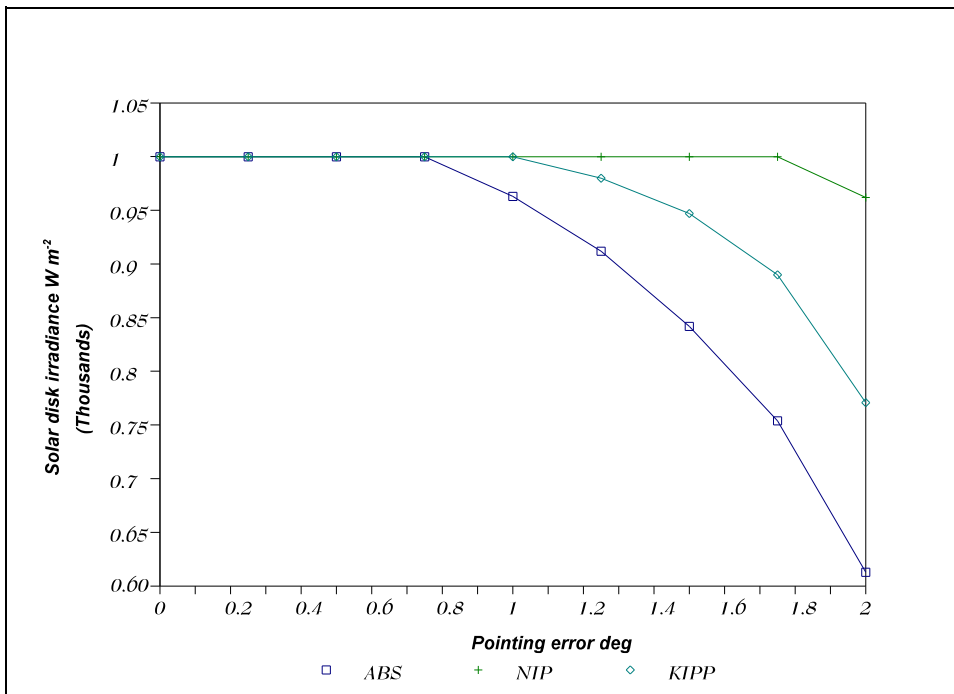

Figure D 1.2. The contribution of the solar disk to the irradiance of pyrheliometric sensors depending on the pointing error. Case of mountain aerosol and 60 degrees solar elevation.

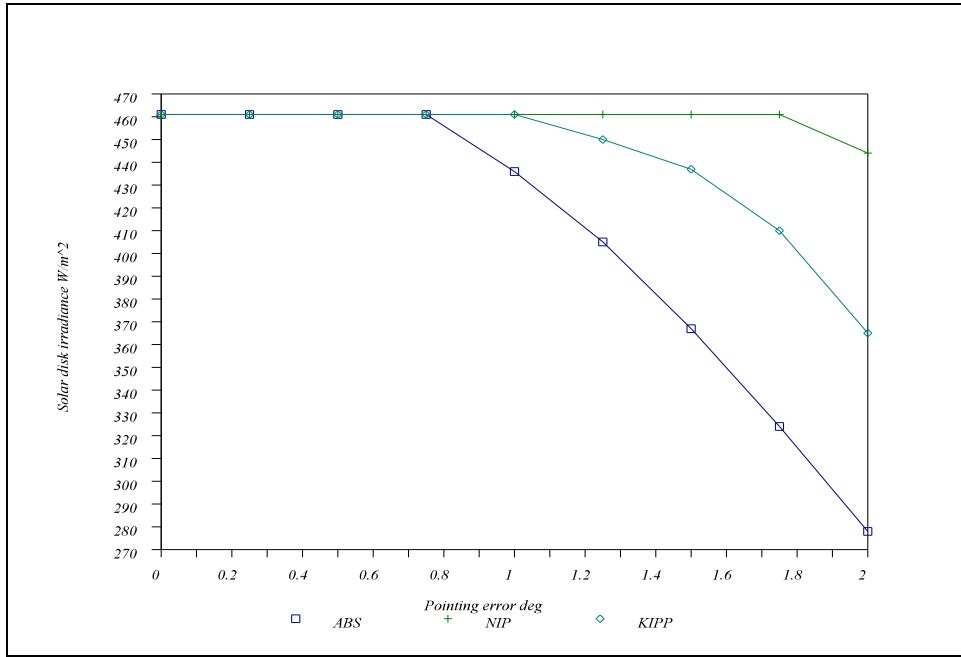

Figure D 1.3. Same as Fig. D 1.2 except the case is for continental background aerosol and 20 degrees solar elevation.

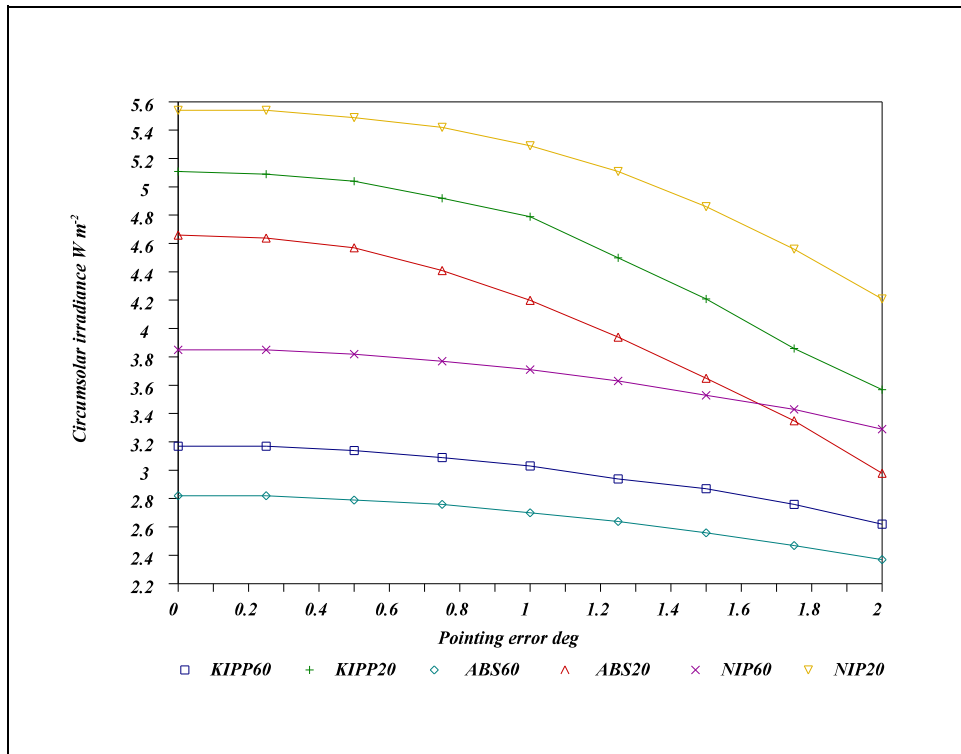

Figure D 1.4. The contribution of the circumsolar sky to the irradiance of pyrheliometric sensors. The upper 3 curves belong to the case of continental background aerosol and 20 degrees solar elevation, the lower 3 curves belong to the case of mountain aerosol and 60 degrees solar elevation. In both group of curves the instruments are from the top to down: NIP, KIPP and ABS.

## D 2. Effect of Clouds on the Pyrheliometric Measurements

Prepared by G. Major for the BSRN Workshop held in Boulder, Co, 12-16 Aug. 1996

### D 2.1 Introduction

In the last BSRN Meeting (Davos, October 1995) the question aroused: how large could be the effect of variable clouds around the Sun on the pyrheliometric measurements? In this report some results are presented.

The basic difficulty of making model calculations is the lack of proper radiance distributions around the Sun for cloudy situations. (For cloudless sky there are radiance distributions for several aerosol types and optical thickness values from several authors.) In this report "cloudy situation" mean that there is cloud near to the Sun (in the ring limited by the circles of 1 and 4 degrees from the solar centre) but not in between the Sun and the measuring pyrheliometer, that is the effect of transmission of cloud layers is not regarded here. High geometrical resolution radiance measurements were made from the solar centre up to 3 degrees by the Lawrence Berkeley Laboratory. The data are available from the National Renewable Energy Laboratory (NREL). They cover all weather situation at one dozen stations in the U.S.A (Noring et al., 1991). A sample of these data has been involved into this work.

Oversimplified assumptions have been used to derive the radiance distributions applied in calculating of the effect of clouds.

### D 2.2 The geometry

The base height of our rectangular model cloud is 2 km, its geometrical thickness is 0.5 km, optical thickness is 25, it is 1 km wide and its length is perpendicular to the solar vertical plane, the solar elevation angle is 45 degrees. The scene is irradiated by the direct and circumsolar beam, the surface irradiance is seen in Figure D 2.1 (personal communication from T. Varnai, McGill University). The edges of the cloud shadow are not sharp, since the left lower and right upper edges of the cloud scatter the solar beam. In this geometrical situation (cloud below or above the Sun) side reflectance into the pyrheliometer is not possible, the cloud affects the pyrheliometric measurement by scattered radiation only (edge scattering).

In the other special geometrical situation the cloud length is parallel with the solar vertical plane, that is the cloud is in the right or left side of the Sun. Now the cloud affects the pyrheliometric measurement by side reflection only.

#### D 2.2.1 Cloud edge scattering

For the example calculation, in Figure. D 2.2, the model cloud is above the Sun. In the cloud the geometrical path length of the radiation beam falling into the pyrheliometer:

$$X = H \left[ \frac{\text{ctg}(h + \beta)}{\cos(h + z)} - \frac{1}{\sin(h + z)} \right]$$

The meaning of the symbols is seen in Figure D 2.2.

Taking into account that the optical depth of the cloud is 25, the optical path length of the beam in the cloud:

$$T(h, \beta, z) = 100 \left[ \frac{\text{ctg}(h + \beta)}{\cos(h + z)} - \frac{1}{\sin(h + z)} \right] \quad z \geq \beta$$

It can be supposed that the radiance along the cloud as seen from the pyrheliometer

Using the data of Figure D 2.1

$$L(z) = A(\beta) \tau \exp(-\tau)$$

$$A(\beta) = A_0 \exp(-0.7 \beta)$$

where the constant  $A_0$  has to be determined to calculate absolute radiance values.

#### D 2.2.2 Cloud side reflectance

Figure D 2.3 shows a cloud in the right side of the Sun. It is supposed that:

- (1) the radiance coming from the cloud side is proportional to the direct radiation,
- (2) the radiance is constant in the viewing angle of the cloud side,
- (3) the viewing angle does not depend on the solar elevation,
- (4) the viewing angle is proportional to the distance from the solar centre.

Again, the absolute value has to be determined.

### D 2.3 Measurements

The National Renewable Energy Laboratory kindly forwarded the circumsolar measurements made at Boardman, OR (latitude 45,7°N) in April and May of 1977. During the daytime the instrument scanned the solar disk and the circumsolar sky (up to 3.2 degree) in every 10 minutes. The resolution is 1.5' in the solar disk and 4.5' in the outer parts. When the solar elevation is low, the scan is parallel with the surface. At solar noon the scan occurs in the solar vertical.

This way, cases for side reflectance could be found in the morning or evening measurements. An example is seen in Figure D 2.4 altogether with the least turbid cloudless cases found in the sample for both the low and high Sun. While the circumsolar radiances are quite near in the clear cases, the cloudy radiances differ significantly from them even in the cloudless part of the sky.

Figure D 2.5 shows circumsolar functions for the edge scattering altogether with the case of the cloudless high Sun. Again: the clear parts of the cloudy cases show much higher radiance than the absolutely clear atmospheric column.

Looking at Figures D 2.4 and D 2.5 one has to remember that real clouds differ much from the above described model one.

### D 2.4 The applied radiance distributions

Considering only the above described measurements and model, the following radiance distribution functions have been selected for further calculation:

- 60 degrees solar elevation, mountain aerosol for the solar disk and clear sky radiances (high clear case)
- 20 degrees solar elevation, continental background aerosol for the solar disk and clear sky radiances (low clear case)
- the above clear cases combined with clouds at 1, 2 and 3 degrees from the solar centre for both the edge scattering and side reflectance situations.

The radiance functions are shown in Figures D 2.6, D 2.7 and D 2.8. For example to calculate the effect of side reflected radiation if the cloud begins at 2 deg, the clear function has been used for the solar disk and circumsolar sky up to 2 degrees, from 2 deg to 2.4 deg the radiance seen in Fig 6, for angles larger 2.4 deg (bottom of the cloud) zero radiance has been taken in to account.

The cloud radiances have been tuned to the measured ones, while the cloudless parts are the same as calculated for the atmospheric column containing the named model aerosol. This latter does not agree with the measurements.

### **D 2.5 The pyrheliometers**

Geometrical differences can be found even amongst the newly developed pyrheliometers. The calculations were made for 4 pyrheliometer geometry (see Fig. D 2.9). ABS represents PMO2, PMO5, Pacrad and HF instruments. CRO3 is the Crommelynck 3L pyrheliometer that has the smallest slope angle and the largest limit angle. The KIPP and NIP thermoelectric pyrheliometers are used for continuous recording of the direct radiation.

### **D 2.6 The effect of clouds**

Calculations have been made for the cloudless atmosphere and for both types of cloudy situation. The distance of clouds from the solar centre was 1, 2 and 3 degrees respectively.

The deviations of calculated outputs of pyrheliometers between the clear and cloudy situations are presented in Figs D2.10 - D2.13. In all cases the cloud increases the radiation entering into the instrument, but the increase never reaches 1 percent.

### **D 2.7 Conclusions**

The presence of clouds in the circumsolar part of the sky increases the output of pyrheliometers but this increase does not exceed 1 percent.

It seems that the observed changes in the output of a pyrheliometer in cloudy conditions are related mainly to changes in the transmission and scattering of the atmospheric column, the scattering and reflection of clouds have smaller effect.

### **D 2.8 Reference**

Noring, J.E., Grether, D.F. and Hunt A.J. 1991: Circumsolar Radiation Data: The Lawrence Berkeley Laboratory Reduced Data Base NREL/TP-262-4429

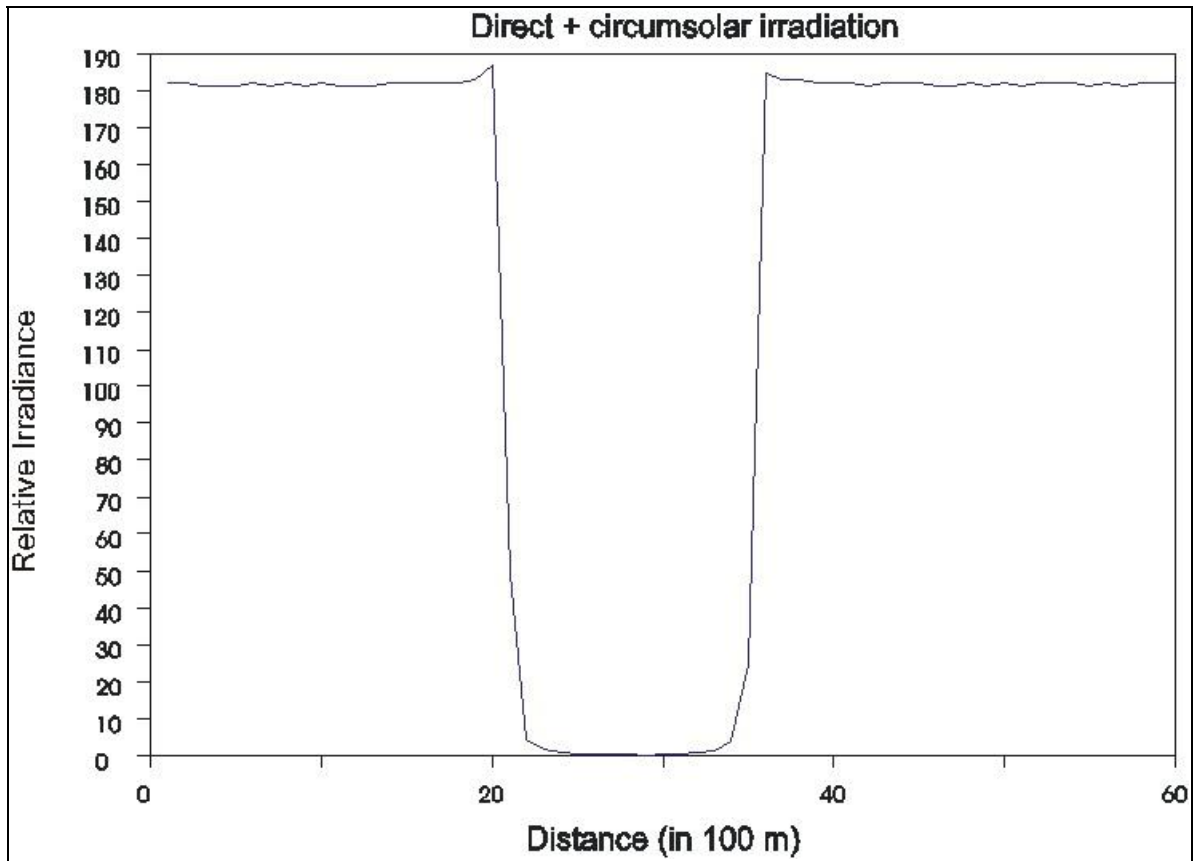

Figure D 2.1. Surface Irradiance: the shadow of the model cloud.

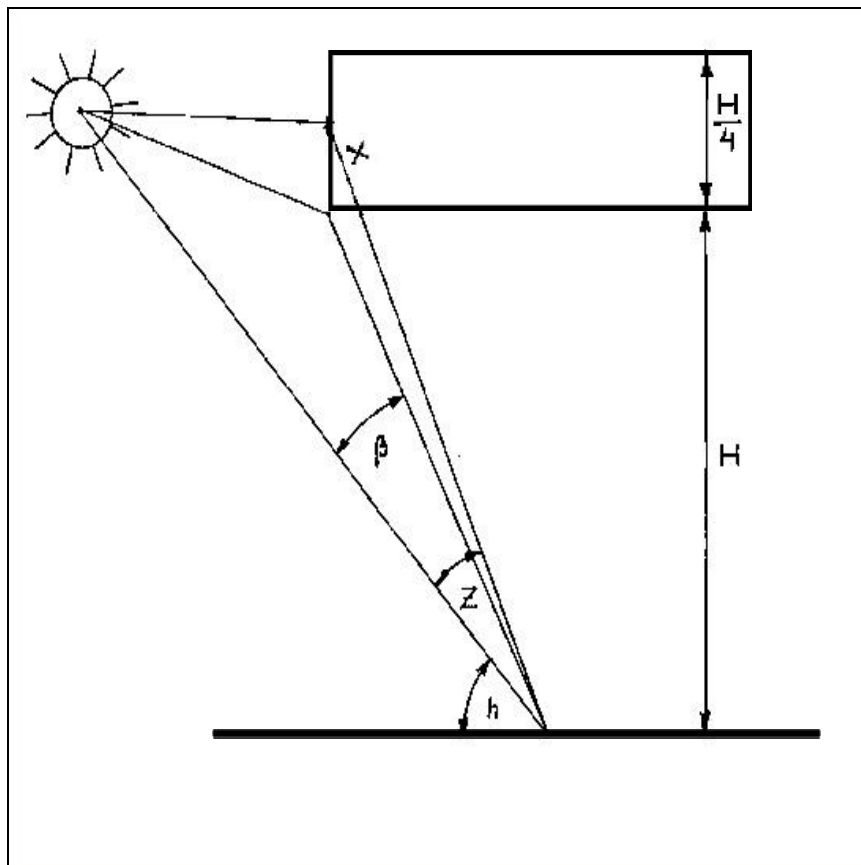

Figure D 2.2. The geometry of cloud edge scattering.

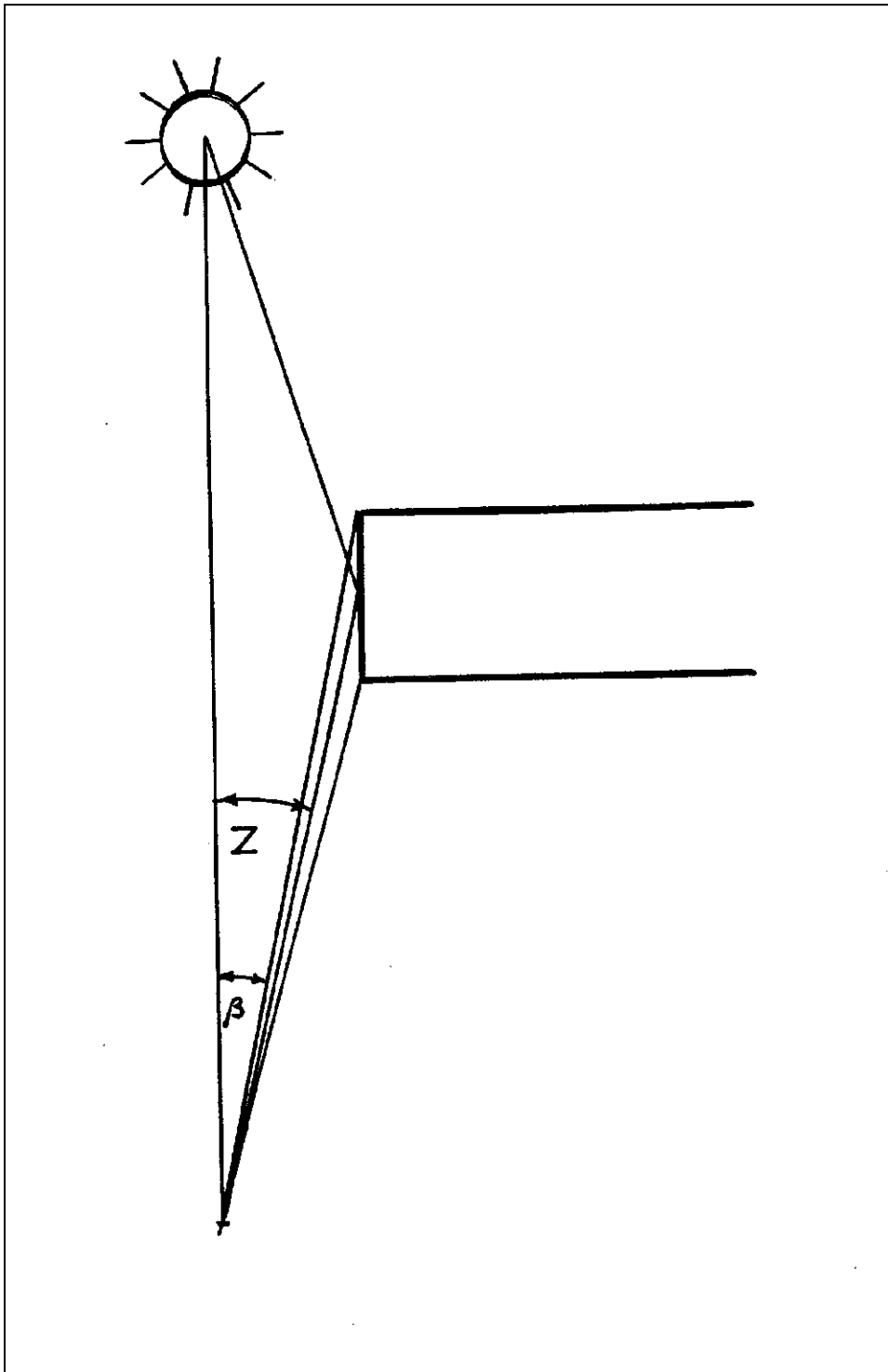

Figure D 2.3. The geometry of cloud side reflectance.

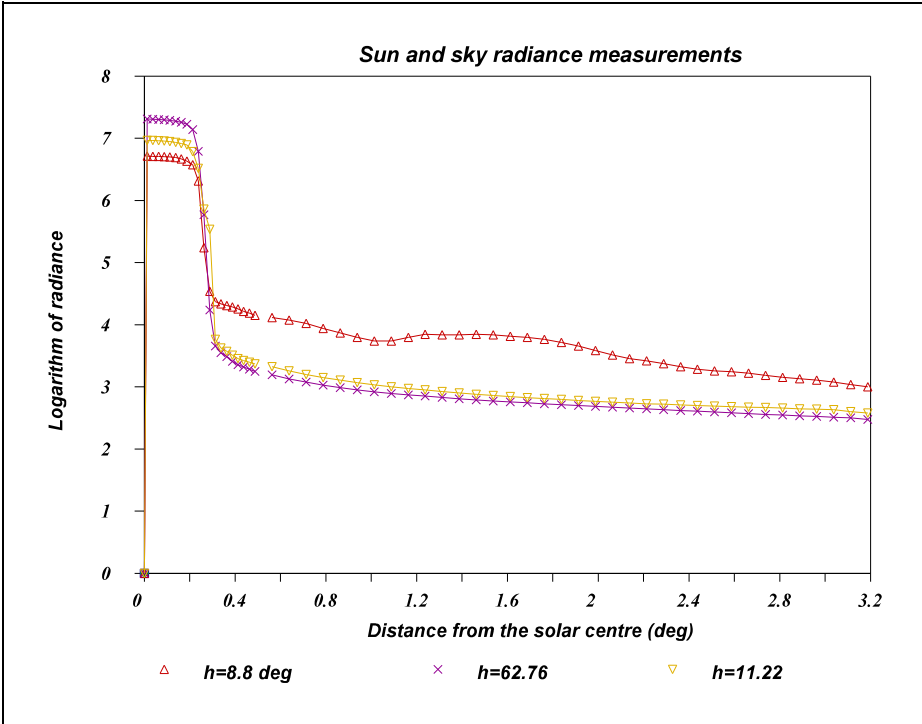

Figure D 2.4. Measured radiance functions: example for the cloud side reflectance (upper curve) as well the clearest cases for high and low solar elevation.

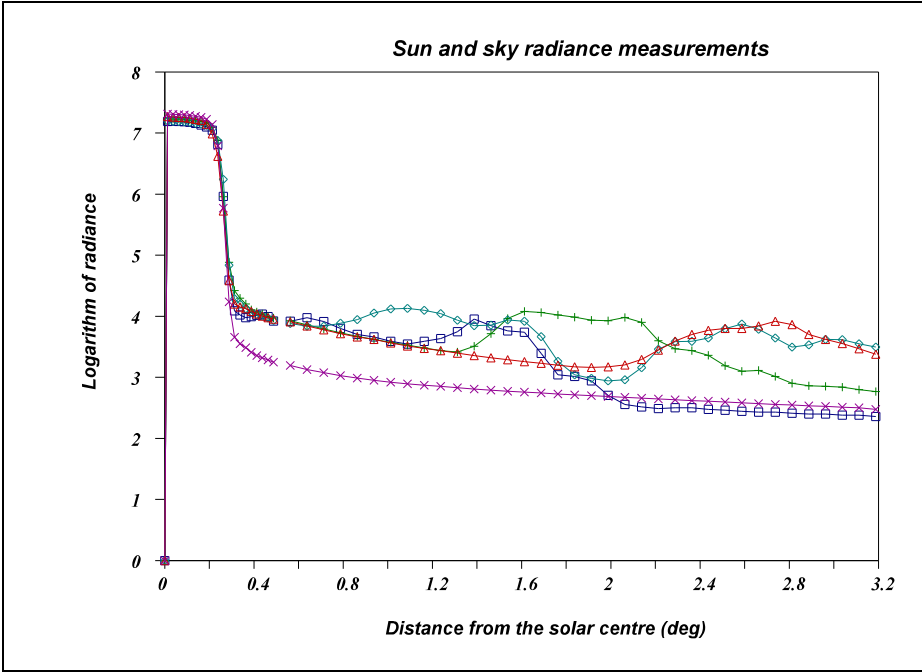

Figure D 2.5. Measured radiance functions: various unidentified examples for cloud edge scattering and the clearest case (cloudless high sun (x)). In all cases the solar elevations is around 60 degrees.

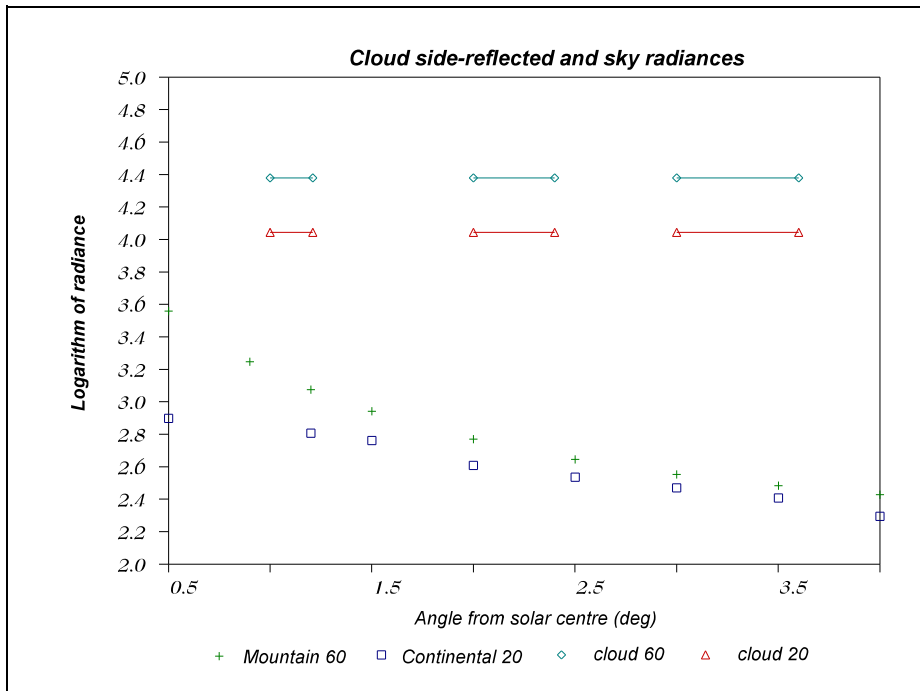

Figure D 2.6. Model radiances of clear sky at 60° solar elevation with mountain aerosol, clear sky at 20° solar elevation with continental background aerosol and the same conditions with cloud at 1, 2 and 3° from the solar centre.

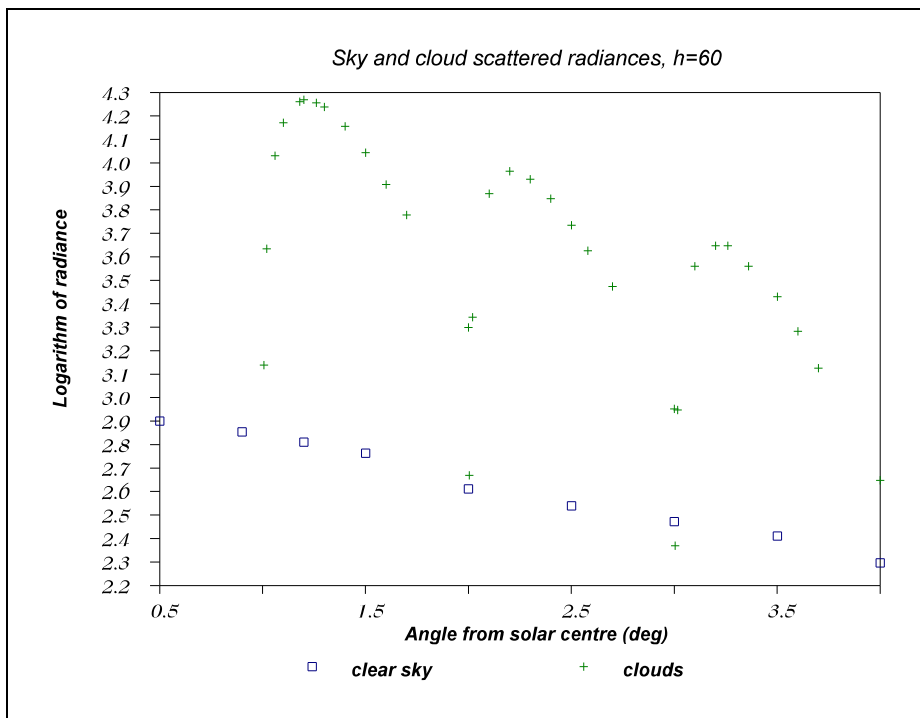

Figure D 2.7. Model radiances for the cloud edge scattering and for the clear sky, mountain aerosol, h=60 degrees.

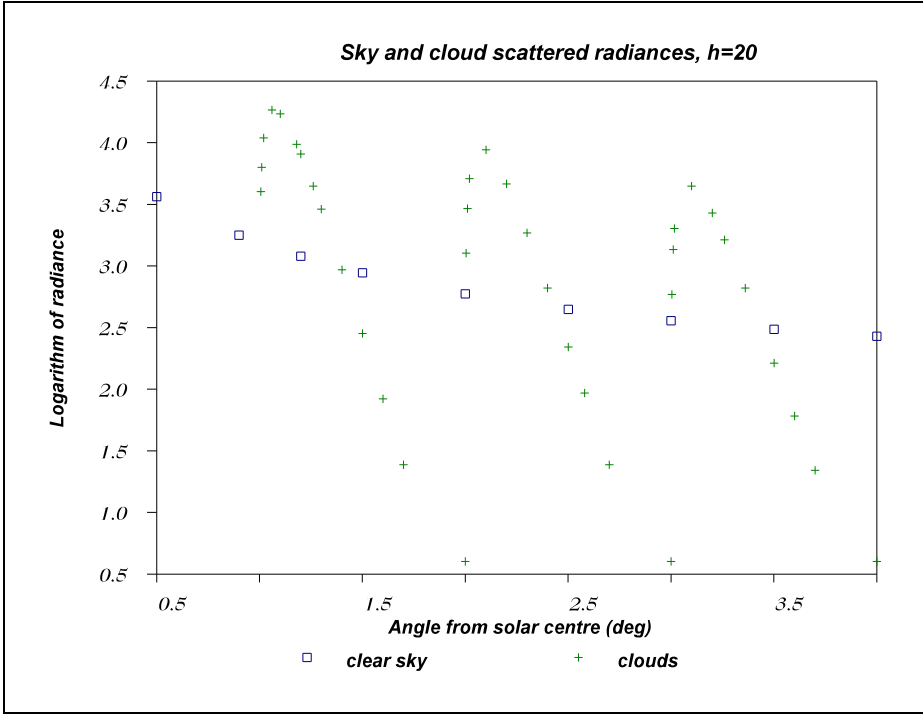

Figure D 2.8. Model radiances for the cloud edge scattering and for the clear sky, background aerosol, h=20 degrees.

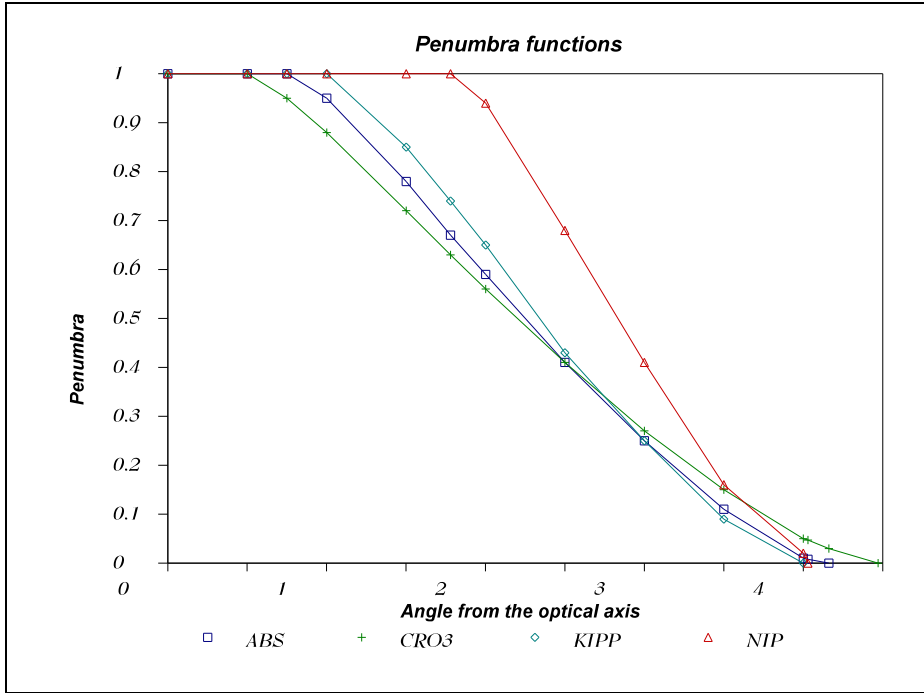

Figure D 2.9. The basic geometrical characteristics of the pyrheliometers involved into the calculation.

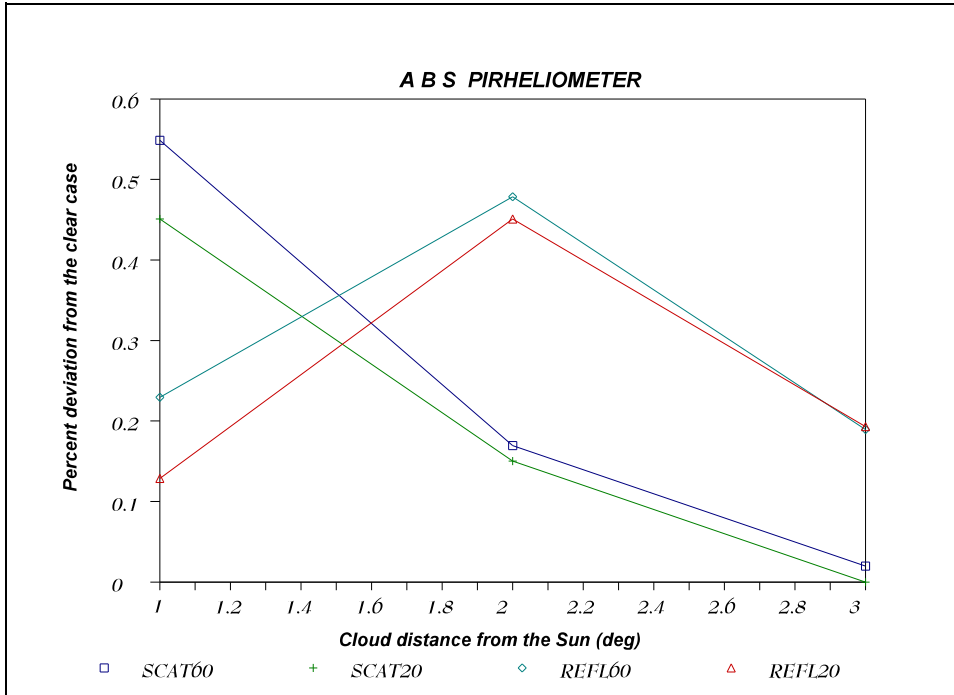

Figure D 2.10. Cloud effect for the ABS pyr heliometer group.

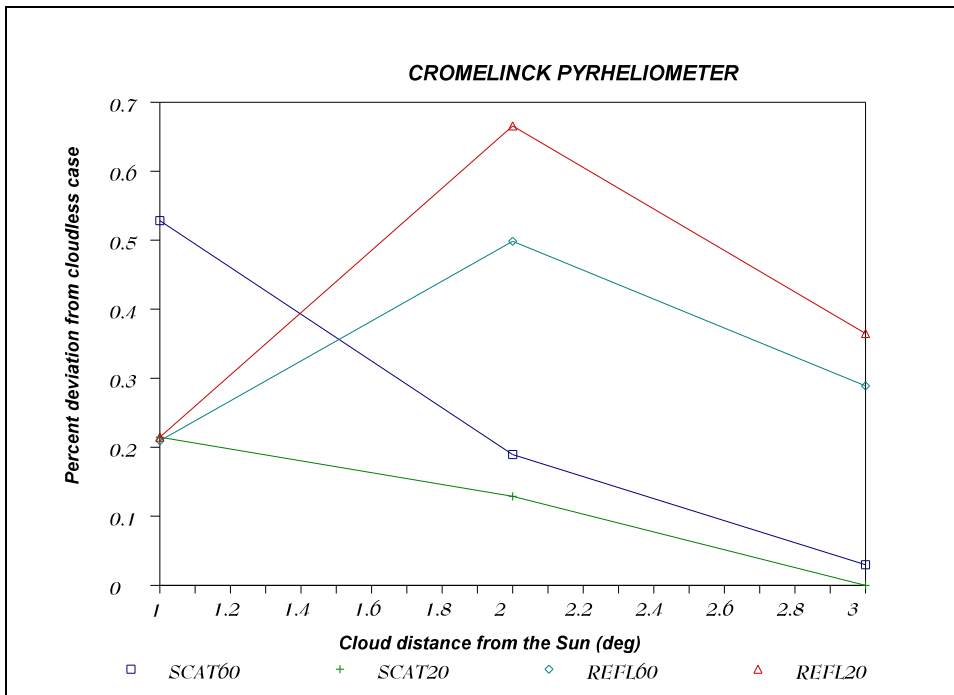

Figure D 2.11. Cloud effect for the Crommelynck 3L pyr heliometer.

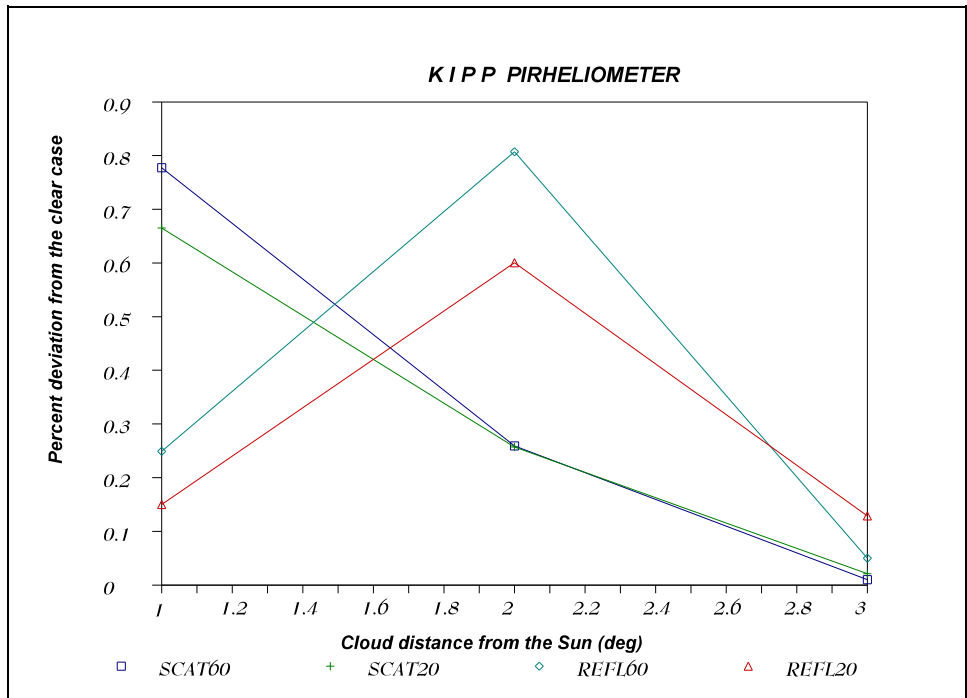

Figure D 2.12. Cloud effect for the KIPP pyr heliometer.

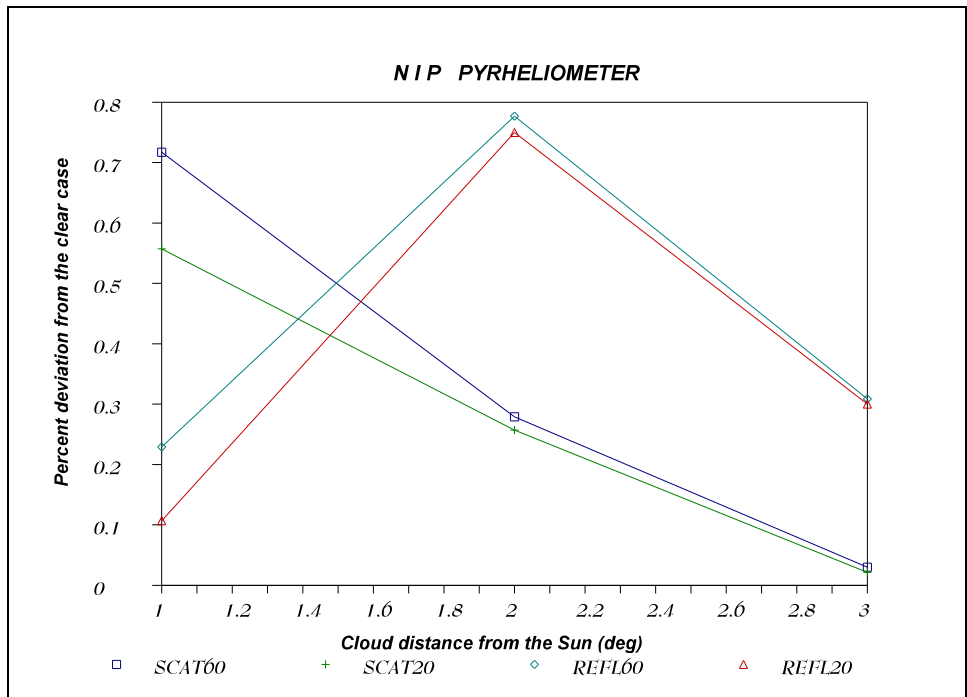

Figure D 2.13. Cloud effect for the NIP pyr heliometer.

## Annex E Suppliers of Solar Tracking Instruments (Partial Listing)

Brusag  
Chapfswiesenstrasse 14  
CH-8712 Stäfa  
Switzerland  
<http://www.brusag.ch/>

Eppley Laboratories  
12 Sheffield Avenue  
PO Box 419  
Newport, Rhode Island 02840  
USA  
<http://www.eppleylab.com/>

Kipp & Zonen B.V.  
Röntgenweg 1, 2624 BD Delft  
P.O. Box 507, 2600 AM Delft  
The Netherlands  
<http://www.kippzonen.com/>

Middleton Instruments  
Carter-Scott Design  
16 Wilson Avenue  
Brunswick, Victoria 3056  
Australia  
<http://www.carterscott.com.au/default.htm>

## Annex F Suppliers of Data Acquisition Systems (Partial Listing)

### F 1. Data Acquisition Types

Although the requirements for observing the basic radiation quantities associated with the BSRN are relatively simple in principle, the need for high accuracy, high resolution observations to be obtained once per second will tax many data acquisition systems if more than a few channels are to be sampled and the BSRN uncertainty requirement in irradiance observations of 0.01% of the reading or  $\pm 1 \mu\text{V}$  (whichever is greater based on an unamplified signal) is to be met.

Three types of data acquisition systems are normally considered for such measurements.

- Type 1 is a bench system consisting of a combination of digital multimeter and a multiplexer. These can be either housed in a single unit or be connected externally. Programming and final data storage are via a desktop computer. These types of systems are highly programmable, are capable of scanning nearly an unlimited number of channels and can normally measure voltage, resistance and current. Type 1 systems are the most accurate and are highly configurable, but must be kept in laboratory conditions and are the most expensive of the three types. Instrument manufacturers such as Keithley Instruments, Fluke or Agilent Technologies are the most common suppliers of this type of instrumentation.
- Type 2 are all-weather data acquisition systems that can be battery operated. Most are only capable of measuring voltage, so bridges must be used to convert resistance measurements. These systems can provide multiple measurement ranges and have on-board computational capabilities. Data can be downloaded from their internal storage by a variety of means, including direct connections to the internet. While most are capable of measuring only 10 or 12 channels, some are expandable, or can be chained to similar systems so that they can behave as a single unit. Units manufactured by Campbell Scientific, Climatronics or Vaisala are in this category.
- The third type of system is installed directly into a desktop computer or is connected to the computer through USB or similar interfaces. Similar to Type 2 systems, these data acquisition cards normally only sample voltages. Software, either provided by the manufacturer or purchased separately is used to program the card. At present, the highest resolution of Type 3 systems is 16-bits. Data storage is directly to the hard-drive of the computer. The major advantage of these cards over either Type 1 or Type 2 systems is the sampling speed is based on a different method of analog to digital conversion that allows speeds up to mega-samples per second. Newer software allows time averaging of such samples to increase the resolution of the measurement.

Table F 1 provides a comparison of the typical capabilities of these data acquisition system types with respect to voltage measurements and whether or not they are capable of measuring resistance directly (e.g. for the measurement of the temperature thermistors in pyrgeometers). Actual specifications and options are dependent on the manufacturer and the model and are continually changing. The table is provided only to assist in understanding the capabilities of the various types of data acquisition systems.

Specification	Type 1	Type 2	Type 3
Analog-to-digital converter type	Integrating	Integrating, Sigma-delta or Successive approximation	Successive approximation, Flash converters
Resolution (bits)	16 - 28	16 - 24	12 - 16
Max. Voltage Resolution ( $\mu$ V)	<0.1	< 1	20 (~ 2 with averaging)
One-year relative uncertainty ( $\mu$ V) for 10 mV reading	$\pm$ 0.2	$\pm$ 10	$\pm$ 20 (averaging of 100 measurements)
Sampling Rate per Second	<30 at 1 PLC	40	100 K
Power line Noise Filtering	Yes	No	No
Autozero Capability	Zero	Some	No
Internal Programming	Yes	Yes	No
Internal Storage	Limited	Yes	No
Direct Resistance & Current Measurement	Yes	Some	No
Cost	High	Medium-High	Low

Table F 1. Typical specifications for the three different types of data acquisition systems available for the measurements of basic BSRN variables.

## F 2. Data Acquisition Suppliers

A partial listing of data acquisition system manufacturers and the type of system(s) produced is provided below. The list is in alphabetical order and is only provided to aid users in obtaining information before selecting a system. Users must also be aware that many systems require additional software and all require regular calibration to operate effectively.

### Agilent Technologies

395 Page Mill Rd.  
P.O. Box #10395  
Palo Alto, CA 94303  
USA  
<http://we.home.agilent.com/>

Type 1

### Campbell Scientific, Inc.

P.O. Box 551  
Logan, UT 84321  
USA  
<http://www.csi.com/>

Type 2

### American Advantech Corporation

No. 1, Alley 20, Lane 26,  
Rueiguang Road, Neihu District,  
Taipei 114, Taiwan, R. O. C.  
<http://www.advantech.com/>

Type 3

### CyberReserach, Inc.

P.O. Box 9565  
New Haven, CT 06535-0565  
<http://www.cyberresearch.com/>

Type 3

**Data Translation Inc.**  
100 Locke Drive  
Marlboro, MA 01752-1192  
USA  
<http://www.datx.com/>

Type 3

**EIS Pty Ltd**  
P.O. Box 281  
Roseville, NSW 2069  
Australia  
<http://www.eis.com.au/DT/DT.htm>

Type 2

**Intelligent Instrumentation, Inc.**  
3000 E. Valencia Road, Suite 100  
Tucson, AZ 85706  
USA  
<http://www.instrument.com/>

Type 3

**John Fluke Manufacturing Co., Inc.**  
Fluke Corporation  
P.O. Box 9090  
6920 Seaway Blvd.  
Everett, Washington, 98206-9090  
<http://www.fluke.com/>

Type 1

**Keithley Test Instrumentation Group**  
Keithley Instruments, Inc.  
28775 Aurora Road  
Cleveland, OH 44139  
USA  
<http://www.keithley.com/>

Type 1 and Type 3

**Logic Beach Inc.**  
8363-6F Center Drive  
La Mesa, CA 91942  
USA  
<http://www.logicbeach.com/>

Type 3

**National Instruments**  
6504 Bridge Point Parkway  
Austin, TX, 78730-5039  
USA  
<http://www.nationalinstruments.com/>

Type 1 (plug-in cards) and Type 3

## Annex G Sample log sheets

The primary reason for keeping a log of the activities about the station is to help in determining the quality of the data. Until recently such logs were kept either by filling out forms on a daily basis or writing information into a station log book. The former has a tendency to encourage the observer/technician to record only those activities that are required by the sheet, while the latter is often used only for extraordinary occurrences or events (e.g. the station was hit by a tornado), but not the routine activities associated with the day-to-day operation of the observatory (e.g. cleaning the instruments). Whatever form is used must be determined in concert with the observer so that the information required by the scientist analysing the data can be easily discovered. Log sheets are essential in the rapid and accurate quality assurance of solar radiation data.

Recently, with the development of sophisticated computer data acquisition programs, the normal log sheet can be completed electronically. The advantage of such a form is that flags set by the data acquisition system can be written to the log automatically. Electronic logs provide a means of directly and permanently linking the data with a record of activities at the observatory. Care must be taken in the design of such a log so that text can be easily added beyond the normal "check-off" information. Furthermore, no matter how automated the site, it is essential to provide a forum for the technician responsible for the maintenance of the instruments, etc. to note any abnormalities.

Most log sheets provide basic checks for the instruments, the trackers, the data acquisition system and the clock. Many provide areas where the technician can insert the local temperature, cloud amount, surface conditions, etc. The overall design should also encourage comments beyond the daily routine information for which the sheet is designed.

The next three pages contain samples of log sheets which have been used successfully. Example 1 is from the University of Calgary, where the log was designed for the International Daylight Measurement Program (only the radiation portion is reproduced). Example 2 is a log sheet developed by the National Renewable Energy Laboratory for the Historically Black Colleges and Universities (HBCU) network of solar radiation stations. Example 3 is a former log sheet developed for the Canadian BSRN site.

U. of C. G. C. Daily Inspection Log Sheets U. of C. Station		Date:	T1:	T2:
		Julian:	T3:	MST DST
Parameter	Instrument	Cleaned	Remarks	Tracking
Beam Irradiance	NIP 28053E6			
Global Illuminance	ELV-641/89			
Global Irradiance	CM11/923949			<p>T1</p>
Diffuse Illuminance	ELV-641/92			
Diffuse Irradiance	CM11/924208			
North Illuminance	ELV-641/87			
East Illuminance	ELV-641/91			
South Illuminance	ELV-641/90			
West Illuminance	ELV-641/88			
North Irradiance	CM11/923952			<p>T2</p> 
East Irradiance	CM11/926954			
South Irradiance	CM11/924210			
West Irradiance	CM11/923951			
Thermistor	107F/C1191			<p>T3</p>
Additional Information:				
WWV Time Signal :				

Figure G 1. Sample log sheet from the University of Calgary.

Station Name: SERT/SREL

For the Period: 5/26/85 to 5/31/85

KEY: ✓ = found in GOOD condition    X = found in BAD condition    0 = corrected  
 A = adjusted  
 Clouds: ○ = Clear (Amount < 1/10)  
 ⊙ = Scattered (1/10 ≤ Amount < 5/10)  
 ⊕ = Broken (5/10 ≤ Amount < 9/10)  
 ⊗ = Overcast (Amount ≥ 9/10)

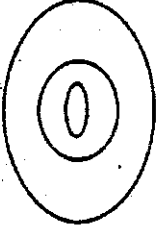
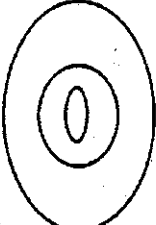
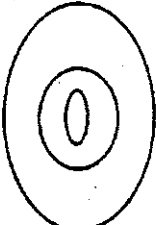
**DATE & TIME**

Day of Year	146	147	148	148	149	150	151
Day of Week	SUN	MON	TUE	TUE	WED	THU	FRI
Month/Day/Year	5-26-85	5-27-85	5-28-85	5-28-85	5-29-85	5-30-85	5-31-85
Standard Time	13:30	07:45	08:10	11:15	09:25	15:10	09:35
Observer (Initials)	TLS	TLS	TLS	VS	VS	MDR	MDR

**GLOBAL HORIZONTAL**

Dome Condition	⊗	✓	✓	✓	⊗	X	⊗
Sensor Level	✓	✓	✓	✓	✓	✓	✓
Desiccant	✓	✓	✓	✓	✓	X	0

**DIFFUSE HORIZONTAL**

Dome Condition	⊗	✓	✓	✓	⊗	X	⊗
Sensor Level	✓	✓	✓	✓	✓	✓	✓
Desiccant	✓	✓	✓	✓	✓	✓	✓
Shading Band	✓	A	✓	✓	✓	A	✓

**DIRECT NORMAL**

NIP Window Condition	⊗	✓	✓	✓	⊗	X	⊗
Tracker Alignment	✓	✓	X	0	✓	✓	✓
Signal Cable	✓	✓	⊗	✓	✓	✓	✓

**DATA ACQUISITION**

Time Display	✓	✓	✓	✓	✓	✓	A
Battery Voltage	12.2	12.2	12.1	12.1	12.2	12.1	12.2
Recorder Counter	125	130	135	137	140	150	155
Tape Change? (Y=yes)	✓	✓	A	✓	✓	✓	Y
Printer Status	✓	✓	A	✓	✓	✓	✓

**WEATHER OBSERVATION**

Cloud Amount	⊙	⊙	○	○	⊕	⊕	⊕
Temperature	79	65	68	85	72	67	65

\* \* \* C O M M E N T S \* \* \*

NIP Target:

⊗	⊙	⊙	⊙	⊗	⊙	⊙	⊗
Moderate Dust Spots on Domes	Adjusted Shadow Band to +21° NIP Alignment in "SAFE" ZONE	Tracker out of Alignment, Signal Cable Swaged on Adjusting Fixture	Tracker Replaced/Aligned at 11:31 (MST)	Light Dust Spots on Domes	Adjusted Shadow Band to +22° Rain Showers Began ~ 9:00 am (MST) Desiccant Turning White	CR-21 Time Reset at 9:40 am (4 minutes slow)	Desiccant Replaced in Horizontal NIP

Send Completed Form(s) EACH FRIDAY To: SERT, 1617 Cole Blvd., Golden, CO 80401  
 ATTN: Val Swarc 215 16/3  
 TAPE OFF: 09:41 ON: 09:46

Figure G 2. Sample log sheet from the NREL HBCU solar radiation network.

**BSRN DAILY LOG AND MAINTENANCE RECORD**

A) Inspection performed by (print): \_\_\_\_\_

B) Date (MM/DD/YY): \_\_\_\_/\_\_\_\_/\_\_\_\_ Time: IN \_\_\_\_:\_\_\_\_ OUT \_\_\_\_:\_\_\_\_

C) Present Conditions:

1. Temperature Interior \_\_\_\_ Degrees C Exterior \_\_\_\_ Degrees C
2. Relative Humidity Interior \_\_\_\_ % Exterior \_\_\_\_ %
3. Cloud Amount \_\_\_\_/10 Cloud Type \_\_\_\_\_
4. Wind Speed \_\_\_\_ km/hr Wind Direction \_\_\_\_ Degrees
5. Surface Condition \_\_\_\_\_

D) Radiation Instrument Maintenance:

	Domes Cleaned	Spirit Level In Circle	Bubble Corrected	Desiccant	
				Active	Replaced
East Tracker NIP	_____	_____	_____	_____	_____
East Tracker PIR	_____	_____	_____	_____	_____
East Tracker CM21	_____	_____	_____	_____	_____
West Tracker NIP	_____	_____	_____	_____	_____
West Tracker PIR	_____	_____	_____	_____	_____
West Tracker CM21	_____	_____	_____	_____	_____
Table East PSP	_____	_____	_____	_____	_____
Table East CM21	_____	_____	_____	_____	_____
Table West PSP	_____	_____	_____	_____	_____
Table West CM21	_____	_____	_____	_____	_____

E) Tracker Operation:

	East Tracker		West Tracker		Explanation
	Correct	Corrected	Correct	Corrected	
NIP on Target	_____	_____	_____	_____	_____
Shade Balls on Target	_____	_____	_____	_____	_____
Computer Time	_____	_____	_____	_____	_____
Computer Date	_____	_____	_____	_____	_____

F) Data Acquisition System:

Date (MM/DD/YY): \_\_\_\_/\_\_\_\_/\_\_\_\_  
 Time: \_\_\_\_:\_\_\_\_  
 Free Disk Space: \_\_\_\_ days  
 DAS resistances checked? \_\_\_\_ Are they in range? \_\_\_\_

G) Comments:

\_\_\_\_\_  
 \_\_\_\_\_  
 \_\_\_\_\_

Figure G 3. Sample log sheet from the Canadian BSRN site.

## Annex H Common Terms and Formulas used in Uncertainty Determinations

The terms and definitions reproduced below are based on those in *Guide to the Expression of Uncertainty in Measurement* (1995), International Organization for Standards.

The ISO, through Recommendation INC-1 (1980) details the expression of uncertainty:

- 1 *The uncertainty in the result of a measurement generally consists of several components which may be grouped into two categories according to the way in which their numerical value is estimated:*
  - A. *those which are evaluated by statistical methods,*
  - B. *those which are evaluated by other means.*

*There is not always a simple correspondence between the classification into categories A or B and the previously used classification into "random" and "systematic" uncertainties. The term "systematic uncertainty" can be misleading and should be avoided.*

*Any detailed report of the uncertainty should consist of a complete list of the components, specifying for each the method used to obtain its numerical value.*

- 2 *The components in category A are characterized by the estimated variances  $S_i^2$  (or the estimated "standard deviations"  $S_i$ ) and the number of degrees of freedom  $\nu_i$ . Where appropriate, the covariances should be given.*
- 3 *The components in category B should be characterised by quantities  $u_j^2$ , which may be considered as approximations to the corresponding variances, the existence of which is assumed. The quantities  $u_j^2$  may be treated like variances and the quantities  $u_j$  like standard deviations. Where appropriate, the covariances should be treated in a similar way.*
- 4 *The combined uncertainty should be characterized by the numerical value obtained by applying the usual method for the combination of variances. The combined uncertainty and its components should be expressed in the form of "standard deviations."*
- 5 *If, for particular applications, it is necessary to multiply the combined uncertainty by a factor to obtain an overall uncertainty, the multiplying factor used must always be stated.*

### H 1. Common Terms

#### Uncertainty

The uncertainty of the result of a measurement reflects the lack of exact knowledge of the value of the measurand. The result of a measurement after correction for recognized systematic effects is still only an *estimate* of the value of the measurand because of the uncertainty arising from random effects and from imperfect correction of the result for systematic effects.

Notes:

- a. The result of a measurement (after corrections) can unknowably be very close to the value of the measurand (and hence have a negligible error) even though it may have a large uncertainty. Thus the uncertainty of the result of a measurement should not be confused with the remaining unknown error.
- b. Possible sources of uncertainty in a measurement may include:
  - i. incomplete definition of the measurand
  - ii. imperfect realization of the definition of the measurand
  - iii. nonrepresentative sampling - the sample measured may not represent the defined measurand
  - iv. inadequate knowledge of the effects of environmental conditions on the measurement or imperfect measurement of environmental conditions
  - v. finite instrument resolution or discrimination threshold
  - vi. inexact values of measurement standards and reference materials
  - vii. inexact values of constants and other parameters obtained from external sources and used in the data-reduction algorithm

- viii. approximations and assumptions incorporated in the measurement method and procedure
- ix. variations in repeated observations of the measurand under apparently identical conditions

### **Standard Uncertainty**

Uncertainty of the result of a measurement expressed as a standard deviation.

### **Type A evaluation (of uncertainty)**

Method of evaluation of uncertainty by the statistical analysis of series of observations.

### **Type B evaluation (of uncertainty)**

Method of evaluation of uncertainty by means other than the statistical analysis of series of observations.

Note:

- a. A Type B evaluation of an uncertainty component is usually based on a pool of comparatively reliable information. For example,
  - i. previous measurement data
  - ii. experience with or general knowledge of the behaviour and properties of relevant materials and instruments
  - iii. manufacturer's specifications
  - iv. data provided in calibration and other certificates
  - v. uncertainties assigned to reference data taken from handbooks

### **Combined Standard Uncertainty**

Standard uncertainty of the result of a measurement when that result is obtained from the values of a number of other quantities, equal to the positive square root of a sum of terms, the terms being the variances or covariances of these other quantities weighted according to how the measurement result varies with changes in these quantities.

### **Expanded Uncertainty**

Quantity defining an interval about the result of a measurement that may be expected to encompass a large fraction of the distribution of values that could reasonably be attributed to the measurand.

Notes:

- a. The fraction may be viewed as the coverage probability or level of confidence of the interval.
- b. To associate a specific level of confidence with the interval defined by the expanded uncertainty requires explicit or implicit assumptions regarding the probability distribution characterized by the measurement result and its combined standard uncertainty. The level of confidence that may be attributed to this interval can be known only to the extent to which such assumptions may be justified.
- c. Expanded uncertainty is termed *overall uncertainty* in paragraph 5 of Recommendation INC-1 (1980).

### **Coverage Factor**

A numerical factor used as a multiplier of the combined standard uncertainty in order to obtain an expanded uncertainty.

Note:

- a. A coverage factor,  $k$ , is typically in the range 2 to 3.

### **(Measurable) quantity**

Attribute of a phenomenon, body or substance that may be distinguished qualitatively and determined quantitatively.

Notes:

- a. The term quantity may refer to a quantity in a general sense or to a particular quantity.
- b. Quantities that can be placed in order of magnitude relative to one another are called quantities of the same kind.
- c. Quantities of the same kind may be grouped together into categories of quantities.

### **Value (of a quantity)**

Magnitude of a particular quantity generally expressed as a unit of measurement multiplied by a number

Notes:

- a. The value of a quantity may be positive, negative or zero.
- b. The value of a quantity may be expressed in more than one way.
- c. The values of quantities of dimension one are generally expressed as pure numbers.
- d. A quantity that cannot be expressed as a unit of measurement multiplied by a number may be expressed by reference to a conventional reference scale or to a measurement procedure or to both.

### **True value (of a quantity)**

Value consistent with the definition of a given particular quantity.

Notes:

- a. This is a value that would be obtained by a perfect measurement.
- b. True values are by nature indeterminate.
- c. The indefinite article "a," rather than the definite article "the," is used in conjunction with "true value" because there may be many values consistent with the definition of a given particular quantity.

### **Conventional true value (of a quantity)**

Value attributed to a particular quantity and accepted, sometimes by convention, as having an uncertainty appropriate for a given purpose.

Notes:

- a. "Conventional true value" is sometimes called assigned value, best estimate of the value, conventional value or reference value.
- b. Frequently, a number of results of measurements of a quantity are used to establish a conventional true value.

### **Measurement**

Set of operations having the object of determining a value of a quantity.

Note:

- a. The operations may be performed automatically.

### **Principle of measurement**

Scientific basis of measurement

### **Method of measurement**

Logical sequence of operations, described generically, used in the performance of measurements.

Note:

- a. Methods of measurement may be qualified in various ways such as:
  - i. Substitution method
  - ii. Differential method
  - iii. Null method

### **Measurement procedure**

Set of operations that are described specifically and are used in the performance of particular measurements according to a given method.

Note:

- a. A measurement procedure is usually recorded in a document that is sometimes itself called a "measurement procedure" (or a measurement method) and is usually in sufficient detail to enable an operator to carry out a measurement without additional information.

### **Measurand**

Particular quantity subject to measurement

Note:

- a. The specification of a measurand may require statements about quantities such as time, temperature and pressure.

**Influence quantity**

Quantity that is not the measurand but that affects the result of the measurement.

**Result of Measurement**

Value attributed to a measurand, obtained by measurement.

Notes:

- a. When a result is given, it should be made clear whether it refers to:
  - i. the indication
  - ii. the uncorrected result
  - iii. the corrected result and whether several values are averaged
- b. A complete statement of the result of a measurement includes information about the uncertainty.

**Uncorrected result**

Result of a measurement before correction for systematic error.

**Corrected result**

Result of a measurement after correction for systematic error.

**Accuracy of measurement**

Closeness of the agreement between the result of a measurement and a true value of the measurand.

Notes:

- a. "Accuracy" is a qualitative concept.
- b. The term precision should not be used for "accuracy".

**Repeatability (of results of measurements)**

Closeness of the agreement between the results of successive measurements of the same measurand carried out under the same conditions of measurement.

Notes:

- a. These conditions are called repeatability conditions.
- b. Repeatability conditions include:
  - i. the same measurement procedure
  - ii. the same observer
  - iii. the same measuring instrument, used under the same conditions
  - iv. the same location
  - v. repetition over a short period of time
- c. Repeatability may be expressed quantitatively in terms of the dispersion characteristics of the result.

**Reproducibility**

Closeness of the agreement between the results of measurements of the same measurand carried out under changed conditions of measurement.

Notes:

- a. A valid statement of reproducibility requires specification of the conditions changed.
- b. The changed conditions may include:
  - i. principle of measurement
  - ii. method of measurement
  - iii. observer
  - iv. measuring instrument
  - v. reference standard
  - vi. location
  - vii. conditions of use
  - viii. time
- c. Reproducibility may be expressed quantitatively in terms of the dispersion characteristics of the results.
- d. Results are here usually understood to be corrected results.

### Experimental standard deviation

For a series of  $n$  measurements of the same measurand, the quantity  $s(q_k)$  characterizing the dispersion of the results and given by the formula:

$$s(q_k) = \sqrt{\frac{\sum_{k=1}^n (q_k - \bar{q})^2}{n-1}}$$

$q_k$  being the result of the  $k^{\text{th}}$  measurement and  $\bar{q}$  being the arithmetic mean of the  $n$  results considered.

Notes:

- Considering the series of  $n$  values as a sample of a distribution,  $\bar{q}$  is an unbiased estimate of the mean  $\mu_q$ , and  $s^2(q_k)$  is an unbiased estimate of the variance  $\sigma^2$ , of that distribution.
- The expression  $s(q_k)/\sqrt{n}$  is an estimate of the standard deviation of the distribution of  $\bar{q}$  and is called the **experimental standard deviation of the mean**.
- “Experimental standard deviation of the mean” is sometimes incorrectly called **standard error of the mean**.

### Uncertainty (of measurement)

Parameter, associated with the result of a measurement that characterizes the dispersion of the values that could reasonably be attributed to the measurand.

Notes:

- The parameter may be, for example, a standard deviation (or a given multiple of it), or the half-width of an interval having a stated level of confidence.
- Uncertainty of measurement comprises, in general, many components. Some of these components may be evaluated from the statistical distribution of the results of series of measurements and can be characterized by experimental standard deviations. The other components, which can also be characterized by standard deviations, are evaluated from assumed probability distributions based on experience or other information.
- It is understood that the result of the measurement is the best estimate of the value of the measurand, and that all components of uncertainty, including those arising from systematic effects, such components associated with corrections and reference standards, contribute to the dispersion.

### Error (of measurement)

Result of a measurement minus a true value of the measurand.

Notes:

- Since a true value cannot be determined, in practice a conventional true value is used.
- When it is necessary to distinguish “error” from “relative error,” the former is sometimes called absolute error of measurement. This should not be confused with absolute value of error, which is the modulus of the error.

### Relative error

Error of measurement divided by a true value of the measurand.

Note:

- Since a true value cannot be determined, in practice a conventional true value is used.

### Random error

Result of a measurement minus the mean that would result from an infinite number of measurements of the same measurand carried out under repeatability conditions.

Notes:

- Random error is equal to error minus systematic error.

- b. Because only a finite number of measurements can be made, it is possible to determine only an estimate of random error.

**Systematic error**

Mean that would result from an infinite number of measurements of the same measurand carried out under repeatability conditions minus a true value of the measurand.

Notes:

- a. Systematic error is equal to error minus random error.
- b. Like true value, systematic error and its causes cannot be completely known.

**Correction**

Value added algebraically to the uncorrected result of a measurement to compensate for systematic error.

Notes:

- a. The correction is equal to the negative of the estimated systematic error.
- b. Since the systematic error cannot be known perfectly, the compensation cannot be complete.

**Correction factor**

Numerical factor by which the uncorrected result of a measurement is multiplied to compensate for systematic error.

Note:

- a. Since the systematic error cannot be known perfectly, the compensation cannot be complete.

## H 2. Common Formulas

### H 2.1 Type A Evaluation

If the number of measurements is  $n$ , and  $x_i$  is the  $i^{\text{th}}$  measurement then:

**Mean**

$$\bar{x} = \sum_i^n x_i / n$$

**Variance**

$$\text{var} = \sum_i^n \frac{(x_i - \bar{x})^2}{n - 1}$$

**Standard Deviation**

$$s = \sqrt{\frac{\sum_i^n (x_i - \bar{x})^2}{n - 1}}$$

**Experimental Standard Deviation of the Mean**

$$ESDM = s / \sqrt{n}$$

**Standard Uncertainty, Type A Evaluation**

$$u = ESDM$$

### H 2.2 Type B Evaluation

Degrees of freedom, from relative uncertainty  $\frac{\Delta u(x_i)}{u(x_i)}$

$$v = 0.5 \left[ \frac{\Delta u(x_i)}{u(x_i)} \right]^{-2}$$

If:

$$R = \frac{\Delta u(x_i)}{u(x_i)} \times 100\%$$

Then:

$$v \approx 0.5 \left[ \frac{100}{R} \right]^{-2}$$

**Rectangular Distribution**

If the semi-range is  $a$ , then the standard uncertainty,  $u$ , is given by:

$$u = \frac{a}{\sqrt{3}}$$

The degrees of freedom ( $\nu$ ) for a rectangular distribution are infinite if the semi-range represents absolute limits.

**Sensitivity Coefficient**

If  $y$  is a function of  $x$ , then the sensitivity coefficient,  $c_i$  is:

$$c_i = \frac{\delta y}{\delta x_i}$$

**Combined Standard Uncertainty**

$$u_c = \sqrt{\sum_i^n (c_i u_i)^2}$$

**Effective Degrees of Freedom**

$$\nu_{eff} = \frac{u_c^4(y)}{\sum_i^n \frac{u_i^4(y)}{\nu_i}}$$

**Coverage Factor**

$k =$  Student's t - factor

**Expanded uncertainty**

$$U = k u_i$$

## **Annex I          Solar Position Algorithm**

An algorithm is provided for the calculation of astronomical parameters in QuickBasic. The subroutine is based upon the publication of Michalsky (1988) and uses the approximation formulae found in the Astronomical Almanac.

C-code based upon Michalsky (1988) can be found at [http://rredc.nrel.gov/solar/codes\\_algs/solpos/#refs](http://rredc.nrel.gov/solar/codes_algs/solpos/#refs). Information on the use of the code and a manual is also available at the site.

Other web-based solar position algorithms can be found at the following locations:

For Excel-based work: <http://users.vei.net/pelican/sunrise.html>

On-line calculation of parameters:          <http://susdesign.com/sunangle/>  
<http://solardat.uoregon.edu/SolarPositionCalculator.html>

A VisualBasic dll (dynamic link library) providing solar position is available by contacting the author at [bruce.mcarthur@ec.gc.ca](mailto:bruce.mcarthur@ec.gc.ca).

Subroutine Solar: Equations based upon the paper of Michalsky (1988) and the approximate equations given in the Astronomical Almanac.

Note: Subroutine call is to be a single line  
SUB AstroAlm (year, jd, GMT, Lat, Lon, StnHeight, Az, El, EOT, SolarTime\$, Decdegrees, Airmass\$, HaDegrees)

```
'=====
' The following subroutine calculates the approximate solar position and is
' based on the following paper:

' Joseph J. Michalsky: The astronomical almanac's algorithm for approximate
' solar position (1950-2050). Solar Energy 40 (3), 227-235 (1988).

' Note also that an Errata notice appeared in Solar Energy Vol. 41, No. 1,
' p. 113, 1988 concerning a correction to the above algorithm. This
' correction has been incorporated into the subroutine that follows.

' In the original subroutine, a division by latitude in the determination of
' of 'elc' (critical elevation) caused a divide by zero error for equatorial
' calculations. This code has been replaced by equivalent code for deter-
' mining solar azimuth.

' This subroutine calculates the local azimuth and elevation of the sun at
' a specific location and time using an approximation to equations used to
' generate tables in The Astronomical Almanac. Refraction correction is added
' so sun position is the apparent one.

' The Astronomical Almanac, U.S. Government Printing Office, Washington, DC

' Input parameters:
' Year    = year (e.g., 1986)
' JD      = day of year (e.g., Feb. 1 = 32)
' GMT     = Greenwich Mean Time (decimal hours)
' Lat     = latitude in degrees (north is positive)
' Lon     = longitude in degrees (west is positive)
' StnHeight = height of station in metres above sea level

' Output parameters:
' Az      = sun azimuth angle
'          (measured east from north, 0 to 360 degrees)
' El      = sun elevation angle (degrees) plus others, but note the
'          units indicated before return to calling routine
' EOT     = equation of time (seconds)
' TST     = True Solar Time (hours)
' SolarTime$ = solar time (HH:MM:SS)
' Decdegrees = declination in degrees
' Airmass$ = airmass as an alphanumeric string
'
' Notes: 1) The algorithm included in the above-mentioned paper was written
'         in Fortran and has been translated into QuickBasic V4.5.
'         2) Since QuickBasic V4.5 does not contain the arcsin function, the
'         following substitute relationship is used:
'         arcsin(x) = ATN(X / SQR(1 - X ^ 2))
'         where ATN is the arctangent.
'         3) The MOD (modulus) function provided by QuickBasic V4.5 is not
'         used since it does not yield the same result as the modulus
'         function in Fortran. For example:
'         in QuickBasic V4.5 19 MOD 6.7 = 5.0 (decimal portion truncated)
'         in Fortran         19 MOD 6.7 = 5.6
'         As a result, the Fortran modulus function has been rewritten
'         using the equivalent:
```

```
' MOD(X,Y) = X (MOD Y) = X - INT(X / Y) * Y
' The INT function in Fortran is identical to that in QuickBasic;
' they both return the sign of x times the greatest integer
' <= ABS(x).
```

```
'=====
```

```
' Work with real double precision variables and define some constants,
' including one to change between degrees and radians.
```

```
DEFDBL A-Z
```

```
Zero = 0#
Point02 = .02#
PointFifteen = .15#
One = 1#
Two = 2#
Four = 4#
Ten = 10#
Twelve = 12#
Fifteen = 15#
Twentyfour = 24#
Sixty = 60#
Ninety = 90#
Ninetyplus = 93.885#
OneEighty = 180#
TwoForty = 240#
ThreeSixty = 360#
ThreeSixtyFive = 365#
FiveOneFiveFourFive = 51545#
TwopointFour = 2400000#: '2.4D6
```

```
pi = Four * ATN(One)
TwoPi = Two * pi
ToRad = pi / OneEighty 'Conversion from degrees to radians
ToDeg = OneEighty / pi 'Conversion from radians to degrees
```

```
basedate = 1949#
baseday = 32916.5#
stdPress = 1013.25#
```

```
' Constants for solar time/location equations
```

```
  C1 = 280.463# :This constant varies by +/- 0.004 per year, but does not change the final values greatly
```

```
  C2 = .9856474#
  C3 = 357.528#
  C4 = .9856003#
  C5 = 1.915#
  C6 = 23.44#
  C7 = .0000004#
  C8 = 6.697375#
  C9 = .0657098242#
```

```
' Constants for refraction equation
```

```
  EC1 = -.56#
  EC2 = 3.51561#
  EC3 = .1594#
  EC4 = .0196#
  EC5 = .00002#
  EC6 = .505#
  EC7 = .0845#
```

```
' Constant for the determination of pressure from station height
```

```

HC1 = .0001184#

' Constant for the calculation of airmass
AC1 = -1.253#

' Get the current julian date (actually add 2,400,000 for JD).
Delta = year - basedate
Leap = INT(Delta / 4)
JulianDy = baseday + Delta * ThreeSixtyFive + Leap + jd + GMT / Twentyfour

' First number is mid. 0 jan 1949 minus 2.4e6; Leap = Leap days since 1949.

' Calculate ecliptic coordinates.
Time = JulianDy - FiveOneFiveFourFive
' 51545.0 + 2.4e6 = noon 1 jan 2000.

' Force mean longitude between 0 and 360 degrees.
MnLon = C1 + C2 * Time
MnLon = MnLon - INT(MnLon / ThreeSixty) * ThreeSixty
IF MnLon < 0 THEN MnLon = MnLon + ThreeSixty

' Mean anomaly in radians between 0 and 2*Pi
MnAnom = C3 + C4 * Time
MnAnom = MnAnom - INT(MnAnom / ThreeSixty) * ThreeSixty
IF MnAnom < 0 THEN MnAnom = MnAnom + ThreeSixty
MnAnom = MnAnom * ToRad

' Compute ecliptic longitude and obliquity of ecliptic in radians.
EcLon = MnLon + C5 * SIN(MnAnom) + Point02 * SIN(Two * MnAnom)
EcLon = EcLon - INT(EcLon / ThreeSixty) * ThreeSixty
IF EcLon < 0 THEN EcLon = EcLon + ThreeSixty
OblqEc = C6 - C7 * Time
EcLon = EcLon * ToRad
OblqEc = OblqEc * ToRad

' Calculate right ascension and declination.
Num = COS(OblqEc) * SIN(EcLon)
Den = COS(EcLon)
Ra = ATN(Num / Den)
IF Den < 0 THEN
    Ra = Ra + pi
ELSEIF Num < 0 THEN
    Ra = Ra + TwoPi
END IF

' Declination in radians.
Dec = SIN(OblqEc) * SIN(EcLon)
Dec = ATN(Dec / SQR(One - Dec * Dec))
' Declination in degrees
Decdegrees = Dec * ToDegrees

' Calculate Greenwich mean sidereal time in hours.
GMST = C8 + C9 * Time + GMT
' GMT not changed to sidereal since 'time' includes the fractional day.
GMST = GMST - INT(GMST / Twentyfour) * Twentyfour
IF GMST < 0 THEN GMST = GMST + Twentyfour

' Calculate local mean sidereal time in radians.
LMST = GMST - Lon / Fifteen
LMST = LMST - INT(LMST / Twentyfour) * Twentyfour
IF LMST < 0 THEN LMST = LMST + Twentyfour
LMST = LMST * Fifteen * ToRad

```

```

' Calculate hour angle in radians between -Pi and Pi.
  Ha = LMST - Ra
  IF Ha < -pi THEN Ha = Ha + TwoPi
  IF Ha > pi THEN Ha = Ha - TwoPi
' Hour angle in degrees, 0 North
  HaDegrees = Ha * ToDegrees + OneEighty
' Local Apparent Time or True Solar Time in hours.
  TST = (Twelve + Ha / pi * Twelve)

' Change latitude to radians.
  Lat = Lat * ToRad
' Calculate azimuth and elevation.

  EI = SIN(Dec) * SIN(Lat) + COS(Dec) * COS(Lat) * COS(Ha)
  EI = ATN(EI / SQR(One - EI * EI))

'Determination of azimuth angle based upon TST
IF TST = Twelve THEN
  Az = pi
ELSE
  cosaz = (SIN(Dec) * COS(Lat) - COS(Dec) * SIN(Lat) * COS(Ha)) / COS(EI)
  Az = -ATN(cosaz / SQR(One - cosaz * cosaz)) + pi / Two
  IF TST > Twelve THEN Az = TwoPi - Az
END IF

' Calculate refraction correction for US standard atmosphere. Need to have
' EI in degrees before calculating correction.
  EI = EI * ToDegrees
  IF EI > EC1 THEN
    Refrac = EC2 * (EC3 + EC4 * EI + EC5 * EI * EI)
    Refrac = Refrac / (One + EC6 * EI + EC7 * EI * EI)
  ELSE
    Refrac = -EC1
  END IF
' Note that 3.51561 = 1013.2 mb/288.2 K which is the ratio of the pressure
' and temperature of the US standard atmosphere.
  EI = EI + Refrac
' Elevation in degrees.

' Convert Az and Lat to degrees before returning.
  Az = Az * ToDegrees
  Lat = Lat * ToDegrees
' MnLon in degrees, GMST in hours, JD in days if 2.4e6 added;
' MnAnom, EcLon, OblqEc, Ra, Dec, LMST, and Ha in radians.

' Calculate the equation of time.
' EOT output in seconds.
  Radeegrees = Ra * ToDegrees
' Test for phase change between MnLon and Ra
  IF (MnLon - Radeegrees) > OneEighty THEN Radeegrees = Radeegrees + ThreeSixty
  EOT = (MnLon - Radeegrees) * TwoForty
' Format True Solar Time HH:MM:SS.
  SHr = INT(TST)
  SMn = INT((TST - SHr) * Sixty)
  SSc = INT(((TST - SHr) * Sixty - SMn) * Sixty) + One
  IF SSc = Sixty THEN SMn = SMn + One: SSc = Zero
  IF SMn = Sixty THEN SHr = SHr + One: SMn = Zero
  IF SHr = Twentyfour THEN SHr = Zero
  IF SHr < Zero THEN SHr = Twentyfour + SHr
  IF SMn < Zero THEN SMn = Sixty + SMn
  IF SSc < Zero THEN SSc = Sixty + SSc
  SolarHr$ = RIGHT$(STR$(SHr), 2)
  IF ABS(SHr) < Ten THEN SolarHr$ = "0" + RIGHT$(STR$(SHr), 1)

```

```

SolarMn$ = RIGHT$(STR$(SMn), 2)
IF ABS(SMn) < Ten THEN SolarMn$ = "0" + RIGHT$(STR$(SMn), 1)
SolarSc$ = RIGHT$(STR$(SSc), 2)
IF ABS(SSc) < Ten THEN SolarSc$ = "0" + RIGHT$(STR$(SSc), 1)
SolarTime$ = SolarHr$ + ":" + SolarMn$ + ":" + SolarSc$

' Solar zenith angle in degrees.
Zenith = (Ninety - EI)

' Station pressure in millibars.
StnPress = stdPress * EXP(-HC1 * StnHeight)

' Calculate the relative optical air mass.
IF (Ninetyplus - Zenith) < Zero THEN
  Airmass$ = "Undefined because sun below horizon"
ELSE
' Airmass calculation of Kasten (1966)
Airmass = StnPress / stdPress * (COS(Zenith * ToRad) + PointFifteen * (Ninetyplus - Zenith) ^ AC1) ^ -One
Airmass$ = STR$(Airmass)
END IF

END SUB

```

## Annex J BSRN Data Management

This annex contains an outline of the BSRN data management. A comprehensive description is given in (Gilgen et al. 1995).

The relationships between the BSRN stations and the WRMC are shown in Figure J1 which is a simplified version of Figure 2.1 in (Gilgen et al. 1995). The observations are made at the BSRN stations. The data are accumulated during a month and their quality is checked by the station scientist. The monthly data sets are then forwarded to the WRMC using the BSRN station-to-archive file format in ASCII code. Data transfer is made preferably by electronic means. The BSRN stations keep the log and the original readings for the duration of the BSRN project to allow anytime for a re-evaluation.

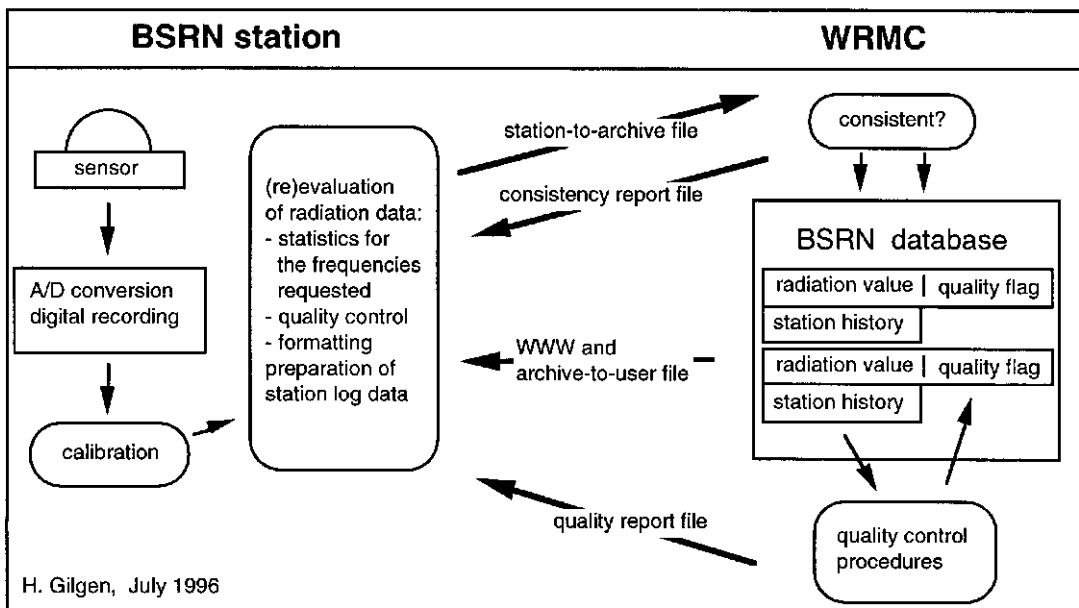

Figure J 1. A BSRN station and the WRMC.

A monthly data set consists of station log data and of atmospheric data (including the radiation data) formatted as prescribed in (Gilgen et al. 1995) and (Hegner et al. 1996). The station log data describe the station, the radiation instruments and the measurements. They are semantically much richer than the atmospheric data and thus are often afflicted with omissions and/or contradictions. Consequently, rules asserting the consistency of the station log data have been incorporated in the definition of the station-to-archive file format, e.g., "an instrument is assigned to every radiative flux". The station log data are written in the first part of the station-to-archive file. The radiation and the other atmospheric data are written in the second part of the station-to-archive file.

The WRMC data manager supports the BSRN station scientists when they start to prepare the monthly data sets: sample station-to-archive files and a format check program are available. It is recommended to apply the format check program before a station-to-archive file is forwarded to the WRMC. The format check program however does not perform consistency checks for the following reason. The consistency checks not only validate the data across the different parts in a site-to-archive file using the rules which are part of the format definition, but they also compare the station log data with the data already stored in the database. Thus, the consistency of a station-to-archive file is checked at the WRMC. If a station-to-archive file is found to be consistent, the data are inserted in the BSRN database. If a file is found to be inconsistent, a detailed consistency report is forwarded to the station concerned. The BSRN station scientist then prepares a consistent monthly batch of data.

On the one hand, the formalization of the descriptions of a station and of the measurements needs some effort when the monthly data sets are prepared for shipping. On the other hand, it is a prerequisite for the systematic treatment of station log data in a database. Only accurate and consistent station log data can be integrated with the radiation data and the other atmospheric data in the BSRN database. The consistency checks assert that the data in the BSRN database do not violate the integrity constraints which are part of the database definition. The BSRN database is managed by the WRMC.

All data in the BSRN database are consistent. The radiation data however may be afflicted with error, though their quality was controlled by the station scientists. Therefore at the WRMC, automated quality control procedures are applied to the radiative flux data to detect erroneous values which subsequently are flagged. The radiation data flagged at the WRMC as being afflicted with error and the reason for the flagging are reported to the station concerned. If the station scientist judges the flagged and/or other data to be questionable, he/she re-evaluates the monthly data set and forwards the new version to the WRMC. The WRMC processes updated versions of the monthly data sets in the same way as the original data sets, except that the older data are deleted from the database. Thus the BSRN database always contains the radiation data judged to be most reliable.

The data in the BSRN database are available to the BSRN station scientists (and to external scientific institutions after a certain delay) in archive-to-user files which are requested by means of a WWW-interface.

The integration of consistent station log data, high-quality radiative flux data and auxiliary atmospheric data in the BSRN database run by the WRMC enables an efficient production of datasets meeting the objectives of the BSRN project.

## References

- Gilgen, H., C. Whitlock, F. Koch, G. Muller, A. Ohmura, D. Steiger, and R. Wheeler, 1995: Technical Plan for BSRN (Baseline Surface Radiation Network) Data Management (Version 2.1, final). World Radiation Monitoring Centre Technical Report 1. WMO/TD-No. 443, World Climate Research Programme (WMO/ICSU), WMO Geneva, 57 pp.
- Hegner, H., G. Muller, V. Nespor, A. Ohmura, R. Steigrad and H. Gilgen, 1996: Updates of the Technical Plan for BSRN Data Management. World Radiation Monitoring Centre Technical Report 2. WMO/TD-No. 882, World Climate Research Programme (WMO/ICSU), WMO, Geneva, 34 pp.

## Index

Aerosol Optical Depth	<a href="#">III</a> , <a href="#">53-56</a> , <a href="#">58</a> , <a href="#">108</a> , <a href="#">114</a>
airmass	<a href="#">57-60</a> , <a href="#">167</a> , <a href="#">169</a> , <a href="#">171</a>
extraterrestrial constant	<a href="#">59</a>
Langley	<a href="#">55</a> , <a href="#">57-60</a> , <a href="#">63</a> , <a href="#">108</a> , <a href="#">111</a>
Ozone	<a href="#">5</a> , <a href="#">7</a> , <a href="#">53</a> , <a href="#">58</a> , <a href="#">62</a> , <a href="#">110</a>
ratio-Langley technique	<a href="#">58</a> , <a href="#">59</a>
Rayleigh	<a href="#">30</a> , <a href="#">53</a> , <a href="#">57</a>
standard lamp	<a href="#">60</a> , <a href="#">61</a> , <a href="#">63</a>
transmissivity	<a href="#">67</a>
Albedo	<a href="#">16</a>
Algorithm	<a href="#">6</a> , <a href="#">11</a> , <a href="#">17</a> , <a href="#">31</a> , <a href="#">40</a> , <a href="#">43</a> , <a href="#">60</a> , <a href="#">73</a> , <a href="#">158</a> , <a href="#">166</a> , <a href="#">167</a>
Aureole	<a href="#">37</a> , <a href="#">53</a> , <a href="#">111</a> , <a href="#">115</a> , <a href="#">123</a>
Baseline Surface Radiation Network	<a href="#">1</a> , <a href="#">I-III</a> , <a href="#">1-18</a> , <a href="#">20</a> , <a href="#">21</a> , <a href="#">30</a> , <a href="#">31</a> , <a href="#">33-35</a> , <a href="#">39-41</a> , <a href="#">43</a> , <a href="#">44</a> , <a href="#">47</a> , <a href="#">51-56</a> , <a href="#">64-68</a> , <a href="#">70</a> , <a href="#">72</a> , <a href="#">74</a> , <a href="#">81</a> , <a href="#">88</a> , <a href="#">113-117</a> , <a href="#">122</a> , <a href="#">126</a> , <a href="#">127</a> , <a href="#">129</a> , <a href="#">131</a> , <a href="#">132</a> , <a href="#">134</a> , <a href="#">135</a> , <a href="#">140</a> , <a href="#">151</a> , <a href="#">152</a> , <a href="#">154</a> , <a href="#">157</a> , <a href="#">172</a> , <a href="#">173</a>
BSRN Archive	
archive	<a href="#">1</a> , <a href="#">11-13</a> , <a href="#">17-21</a> , <a href="#">24</a> , <a href="#">44</a> , <a href="#">53</a> , <a href="#">54</a> , <a href="#">56</a> , <a href="#">62</a> , <a href="#">63</a> , <a href="#">66</a> , <a href="#">70</a> , <a href="#">73</a> , <a href="#">74</a> , <a href="#">172</a> , <a href="#">173</a>
data management	<a href="#">18</a> , <a href="#">53</a> , <a href="#">74</a> , <a href="#">172</a> , <a href="#">173</a>
data submission	<a href="#">74</a>
BSRN Site	
accessibility	<a href="#">45</a>
elevation	<a href="#">12</a> , <a href="#">13</a> , <a href="#">17-19</a> , <a href="#">21</a> , <a href="#">24</a> , <a href="#">32</a> , <a href="#">35</a> , <a href="#">37</a> , <a href="#">41</a> , <a href="#">56</a> , <a href="#">61</a> , <a href="#">117-120</a> , <a href="#">124</a> , <a href="#">125</a> , <a href="#">127</a> , <a href="#">135</a> , <a href="#">136</a> , <a href="#">138-141</a> , <a href="#">145</a> , <a href="#">167</a> , <a href="#">170</a>
horizon	<a href="#">16</a> , <a href="#">17</a> , <a href="#">19-21</a> , <a href="#">25-27</a> , <a href="#">35</a> , <a href="#">38</a> , <a href="#">42</a> , <a href="#">52</a> , <a href="#">56</a> , <a href="#">171</a>
latitude	<a href="#">1</a> , <a href="#">2</a> , <a href="#">17</a> , <a href="#">19</a> , <a href="#">35</a> , <a href="#">38</a> , <a href="#">41</a> , <a href="#">43</a> , <a href="#">58</a> , <a href="#">65</a> , <a href="#">141</a> , <a href="#">167</a> , <a href="#">170</a>
location	<a href="#">2</a> , <a href="#">3</a> , <a href="#">6</a> , <a href="#">9</a> , <a href="#">12</a> , <a href="#">16-19</a> , <a href="#">21</a> , <a href="#">24-26</a> , <a href="#">28</a> , <a href="#">34</a> , <a href="#">40</a> , <a href="#">41</a> , <a href="#">45</a> , <a href="#">48-50</a> , <a href="#">66</a> , <a href="#">67</a> , <a href="#">73</a> , <a href="#">74</a> , <a href="#">81</a> , <a href="#">161</a> , <a href="#">167</a> , <a href="#">168</a>
longitude	<a href="#">2</a> , <a href="#">17</a> , <a href="#">19</a> , <a href="#">41</a> , <a href="#">43</a> , <a href="#">167</a> , <a href="#">169</a>
map	<a href="#">1</a> , <a href="#">17-19</a> , <a href="#">21</a> , <a href="#">28</a> , <a href="#">41</a> , <a href="#">81</a>
photograph	<a href="#">20</a> , <a href="#">21</a> , <a href="#">34</a> , <a href="#">81</a>
security	<a href="#">23</a> , <a href="#">24</a>
site description	<a href="#">18-20</a> , <a href="#">75</a> , <a href="#">81</a>
topography	<a href="#">17-19</a> , <a href="#">81</a>
Circumsolar	<a href="#">11</a> , <a href="#">35</a> , <a href="#">103</a> , <a href="#">114-126</a> , <a href="#">128</a> , <a href="#">134-137</a> , <a href="#">139-142</a>
Climate	<a href="#">1</a> , <a href="#">I</a> , <a href="#">III</a> , <a href="#">1</a> , <a href="#">2</a> , <a href="#">4</a> , <a href="#">6</a> , <a href="#">16-19</a> , <a href="#">23-25</a> , <a href="#">30</a> , <a href="#">45</a> , <a href="#">52</a> , <a href="#">53</a> , <a href="#">64</a> , <a href="#">74</a> , <a href="#">114</a> , <a href="#">173</a>
Communication	<a href="#">14</a> , <a href="#">15</a> , <a href="#">22-24</a> , <a href="#">28</a> , <a href="#">35</a> , <a href="#">140</a>
Computer	<a href="#">14</a> , <a href="#">15</a> , <a href="#">22-24</a> , <a href="#">35</a> , <a href="#">36</a> , <a href="#">38</a> , <a href="#">40</a> , <a href="#">42-45</a> , <a href="#">49</a> , <a href="#">50</a> , <a href="#">99</a> , <a href="#">116</a> , <a href="#">151</a> , <a href="#">154</a>
File Transfer Protocol	<a href="#">74</a>
internet	<a href="#">14</a> , <a href="#">15</a> , <a href="#">22</a> , <a href="#">43</a> , <a href="#">74</a> , <a href="#">151</a>
Local Area Network	<a href="#">15</a> , <a href="#">22</a> , <a href="#">23</a>
Data Collection Instrumentation	
DAS	<a href="#">15</a> , <a href="#">44</a> , <a href="#">45</a> , <a href="#">70</a> , <a href="#">72</a> , <a href="#">73</a>
data acquisition system	<a href="#">8</a> , <a href="#">15</a> , <a href="#">19</a> , <a href="#">22</a> , <a href="#">27</a> , <a href="#">28</a> , <a href="#">44-46</a> , <a href="#">48</a> , <a href="#">51</a> , <a href="#">52</a> , <a href="#">56</a> , <a href="#">64</a> , <a href="#">65</a> , <a href="#">68</a> , <a href="#">151</a> , <a href="#">152</a> , <a href="#">154</a>
data logger	<a href="#">23</a> , <a href="#">24</a> , <a href="#">45</a> , <a href="#">108</a>
sampling rate	<a href="#">5</a> , <a href="#">8</a> , <a href="#">9</a> , <a href="#">53</a>
Diffusometer	<a href="#">116</a> , <a href="#">117</a> , <a href="#">120</a> , <a href="#">122-130</a> , <a href="#">134</a>
Electrical Cable	<a href="#">28</a>
Electrical Power	<a href="#">8</a> , <a href="#">15</a> , <a href="#">21</a> , <a href="#">22</a> , <a href="#">24</a> , <a href="#">27</a> , <a href="#">28</a> , <a href="#">33</a> , <a href="#">34</a> , <a href="#">41</a> , <a href="#">43</a> , <a href="#">45</a> , <a href="#">46</a> , <a href="#">48-50</a> , <a href="#">96</a> , <a href="#">99-101</a> , <a href="#">104</a> , <a href="#">106-112</a> , <a href="#">152</a>

Instrument Platform .....	<a href="#">15</a> , <a href="#">24</a> , <a href="#">26</a> , <a href="#">28</a> , <a href="#">31</a>
Instruments	
absolute cavity radiometer .....	<a href="#">10</a> , <a href="#">64</a> , <a href="#">89</a>
active cavity radiometer .....	<a href="#">38</a> , <a href="#">40</a>
bubble level .....	<a href="#">31</a> , <a href="#">32</a> , <a href="#">38</a> , <a href="#">39</a> , <a href="#">96</a>
calibration ...	<a href="#">1</a> , <a href="#">2</a> , <a href="#">4-6</a> , <a href="#">10</a> , <a href="#">12</a> , <a href="#">13</a> , <a href="#">19</a> , <a href="#">39</a> , <a href="#">48</a> , <a href="#">51</a> , <a href="#">52</a> , <a href="#">54</a> , <a href="#">56-61</a> , <a href="#">63-67</a> , <a href="#">70</a> , <a href="#">71</a> , <a href="#">81</a> , <a href="#">91</a> , <a href="#">96</a> , <a href="#">97</a> , <a href="#">99</a> , <a href="#">101</a> , <a href="#">102</a> , <a href="#">104</a> , <a href="#">106</a> , <a href="#">108</a> , <a href="#">109</a> , <a href="#">152</a> , <a href="#">159</a>
cleaning .....	<a href="#">26</a> , <a href="#">47</a> , <a href="#">48</a> , <a href="#">50</a> , <a href="#">61</a> , <a href="#">62</a> , <a href="#">73</a> , <a href="#">154</a>
dome ..	<a href="#">8</a> , <a href="#">11-13</a> , <a href="#">30</a> , <a href="#">31</a> , <a href="#">33</a> , <a href="#">35</a> , <a href="#">39</a> , <a href="#">46-48</a> , <a href="#">50</a> , <a href="#">67</a> , <a href="#">68</a> , <a href="#">72</a> , <a href="#">73</a> , <a href="#">93</a> , <a href="#">94</a> , <a href="#">96</a> , <a href="#">97</a> , <a href="#">107</a> , <a href="#">116</a> , <a href="#">126</a> , <a href="#">127</a> , <a href="#">134</a>
filter .....	<a href="#">54</a> , <a href="#">55</a> , <a href="#">59-61</a> , <a href="#">63</a> , <a href="#">67</a> , <a href="#">102</a> , <a href="#">106-109</a> , <a href="#">111</a>
installation .....	<a href="#">5</a> , <a href="#">17</a> , <a href="#">21-24</a> , <a href="#">26</a> , <a href="#">27</a> , <a href="#">30-34</a> , <a href="#">38-41</a> , <a href="#">45</a> , <a href="#">46</a>
levelling .....	<a href="#">32</a> , <a href="#">38</a> , <a href="#">39</a> , <a href="#">42</a> , <a href="#">91</a>
manufacturer .....	<a href="#">5</a> , <a href="#">12</a> , <a href="#">30</a> , <a href="#">31</a> , <a href="#">39</a> , <a href="#">40</a> , <a href="#">43</a> , <a href="#">45</a> , <a href="#">46</a> , <a href="#">50-52</a> , <a href="#">55</a> , <a href="#">62</a> , <a href="#">63</a> , <a href="#">66</a> , <a href="#">72</a> , <a href="#">88</a> , <a href="#">151</a> , <a href="#">152</a> , <a href="#">159</a>
meteorological .....	<a href="#">25</a>
pyranometer ..	<a href="#">11</a> , <a href="#">12</a> , <a href="#">26</a> , <a href="#">27</a> , <a href="#">30</a> , <a href="#">32-37</a> , <a href="#">39</a> , <a href="#">42</a> , <a href="#">43</a> , <a href="#">45</a> , <a href="#">46</a> , <a href="#">66</a> , <a href="#">67</a> , <a href="#">70</a> , <a href="#">71</a> , <a href="#">73</a> , <a href="#">88</a> , <a href="#">89</a> , <a href="#">91</a> , <a href="#">93-97</a> , <a href="#">106</a> , <a href="#">114</a> , <a href="#">117</a> , <a href="#">121</a> , <a href="#">124</a> , <a href="#">126-129</a> , <a href="#">131</a> , <a href="#">132</a> , <a href="#">134</a>
pyrgeometer .....	<a href="#">12</a> , <a href="#">13</a> , <a href="#">35</a> , <a href="#">38</a> , <a href="#">39</a> , <a href="#">42</a> , <a href="#">46</a> , <a href="#">48</a> , <a href="#">51</a> , <a href="#">64</a> , <a href="#">67</a> , <a href="#">68</a> , <a href="#">71</a> , <a href="#">72</a> , <a href="#">74</a> , <a href="#">106</a> , <a href="#">107</a>
pyrheliometer .....	<a href="#">9-11</a> , <a href="#">30</a> , <a href="#">35</a> , <a href="#">36</a> , <a href="#">38-41</a> , <a href="#">43</a> , <a href="#">50</a> , <a href="#">64-67</a> , <a href="#">70</a> , <a href="#">88</a> , <a href="#">90</a> , <a href="#">99</a> , <a href="#">101-104</a> , <a href="#">111</a> , <a href="#">114</a> , <a href="#">117</a> , <a href="#">121</a> , <a href="#">124-129</a> , <a href="#">131</a> , <a href="#">132</a> , <a href="#">134-137</a> , <a href="#">140</a> , <a href="#">142</a> , <a href="#">148</a> , <a href="#">149</a>
sunphotometer .....	<a href="#">36</a> , <a href="#">53</a> , <a href="#">109-111</a>
temperature compensation circuit .....	<a href="#">31</a> , <a href="#">40</a> , <a href="#">107</a>
thermistor .....	<a href="#">8</a> , <a href="#">12</a> , <a href="#">68</a> , <a href="#">69</a> , <a href="#">72</a> , <a href="#">97</a> , <a href="#">99</a> , <a href="#">103</a> , <a href="#">105-107</a>
ventilator .....	<a href="#">32</a> , <a href="#">33</a> , <a href="#">35</a> , <a href="#">48</a> , <a href="#">51</a> , <a href="#">68</a> , <a href="#">72</a> , <a href="#">106</a>
Irradiance	
diffuse irradiance .....	<a href="#">5</a> , <a href="#">8</a> , <a href="#">11-13</a> , <a href="#">30</a> , <a href="#">34</a> , <a href="#">50</a> , <a href="#">64</a> , <a href="#">72</a> , <a href="#">74</a> , <a href="#">126</a>
direct irradiance .....	<a href="#">35</a> , <a href="#">136</a>
global irradiance .....	<a href="#">11</a> , <a href="#">12</a> , <a href="#">30</a> , <a href="#">35</a> , <a href="#">89</a>
Maintenance .....	
annual .....	<a href="#">3-5</a> , <a href="#">9</a> , <a href="#">21</a> , <a href="#">24</a> , <a href="#">28</a> , <a href="#">32</a> , <a href="#">34</a> , <a href="#">35</a> , <a href="#">40</a> , <a href="#">43</a> , <a href="#">45</a> , <a href="#">47</a> , <a href="#">48</a> , <a href="#">51</a> , <a href="#">52</a> , <a href="#">61</a> , <a href="#">64</a> , <a href="#">70</a> , <a href="#">72</a> , <a href="#">154</a>
daily .....	<a href="#">48</a> , <a href="#">51</a> , <a href="#">52</a>
semi-annual .....	<a href="#">21</a> , <a href="#">34</a> , <a href="#">47</a> , <a href="#">51</a> , <a href="#">61</a> , <a href="#">70</a>
weekly .....	<a href="#">51</a>
Meteorological Variables .....	
	<a href="#">13</a> , <a href="#">14</a> , <a href="#">19</a> , <a href="#">21</a> , <a href="#">70</a>
Precipitation .....	
	<a href="#">10</a> , <a href="#">14</a> , <a href="#">25</a> , <a href="#">34</a> , <a href="#">47</a> , <a href="#">49</a> , <a href="#">61</a>
Quality Assurance .....	
	<a href="#">5</a> , <a href="#">7</a> , <a href="#">30</a> , <a href="#">36</a> , <a href="#">58</a> , <a href="#">62</a> , <a href="#">70</a> , <a href="#">72</a> , <a href="#">154</a>
Quality Control .....	
	<a href="#">4</a> , <a href="#">7</a> , <a href="#">12</a> , <a href="#">45</a> , <a href="#">108</a> , <a href="#">173</a>
Radiation	
diffuse ....	<a href="#">10-12</a> , <a href="#">17</a> , <a href="#">24</a> , <a href="#">25</a> , <a href="#">30</a> , <a href="#">34-36</a> , <a href="#">38</a> , <a href="#">41</a> , <a href="#">50</a> , <a href="#">51</a> , <a href="#">62</a> , <a href="#">66</a> , <a href="#">67</a> , <a href="#">71</a> , <a href="#">73</a> , <a href="#">89</a> , <a href="#">106</a> , <a href="#">108</a> , <a href="#">113-126</a> , <a href="#">128</a> , <a href="#">129</a> , <a href="#">132</a>
direct beam .....	<a href="#">10-12</a> , <a href="#">17</a> , <a href="#">21</a> , <a href="#">25</a> , <a href="#">30</a> , <a href="#">34-36</a> , <a href="#">38-40</a> , <a href="#">48</a> , <a href="#">50</a> , <a href="#">64-67</a> , <a href="#">73</a> , <a href="#">89</a> , <a href="#">125</a>
global ..	<a href="#">1</a> , <a href="#">2</a> , <a href="#">6</a> , <a href="#">10-12</a> , <a href="#">14</a> , <a href="#">16-19</a> , <a href="#">23</a> , <a href="#">25</a> , <a href="#">30</a> , <a href="#">32</a> , <a href="#">35</a> , <a href="#">36</a> , <a href="#">51</a> , <a href="#">53</a> , <a href="#">66</a> , <a href="#">67</a> , <a href="#">73</a> , <a href="#">89</a> , <a href="#">114</a> , <a href="#">121</a> , <a href="#">123-125</a> , <a href="#">128</a>
infrared .....	<a href="#">5</a> , <a href="#">6</a> , <a href="#">8-10</a> , <a href="#">12</a> , <a href="#">13</a> , <a href="#">25</a> , <a href="#">30</a> , <a href="#">38</a> , <a href="#">50</a> , <a href="#">64</a> , <a href="#">67</a> , <a href="#">69</a> , <a href="#">71</a> , <a href="#">72</a> , <a href="#">74</a> , <a href="#">106</a> , <a href="#">107</a> , <a href="#">117</a>
reflectance .....	<a href="#">6</a> , <a href="#">16</a> , <a href="#">25</a> , <a href="#">140</a> , <a href="#">141</a> , <a href="#">144</a> , <a href="#">145</a>
Ultraviolet .....	<a href="#">6</a>
Radiation budget .....	
	<a href="#">III</a> , <a href="#">1</a> , <a href="#">2</a> , <a href="#">5</a> , <a href="#">53</a>
Radiometer	
field of view .....	<a href="#">10</a> , <a href="#">21</a> , <a href="#">24</a> , <a href="#">27</a> , <a href="#">34</a> , <a href="#">38</a> , <a href="#">40</a> , <a href="#">49</a> , <a href="#">63</a> , <a href="#">66</a> , <a href="#">81</a> , <a href="#">95</a> , <a href="#">99-101</a> , <a href="#">107-111</a>
responsivity .....	<a href="#">8</a> , <a href="#">11</a> , <a href="#">30</a> , <a href="#">31</a> , <a href="#">39</a> , <a href="#">48</a> , <a href="#">55</a> , <a href="#">59</a> , <a href="#">61</a> , <a href="#">63-67</a> , <a href="#">70</a> , <a href="#">71</a> , <a href="#">89</a> , <a href="#">90</a> , <a href="#">92-96</a> , <a href="#">104</a>
Scientist .....	
	<a href="#">II</a> , <a href="#">1</a> , <a href="#">2</a> , <a href="#">4</a> , <a href="#">5</a> , <a href="#">8</a> , <a href="#">9</a> , <a href="#">13</a> , <a href="#">50</a> , <a href="#">53</a> , <a href="#">54</a> , <a href="#">64</a> , <a href="#">74</a> , <a href="#">88</a> , <a href="#">126</a> , <a href="#">154</a> , <a href="#">172</a> , <a href="#">173</a>

Shade	<a href="#">11</a> , <a href="#">25</a> , <a href="#">33-35</a> , <a href="#">37</a> , <a href="#">66</a> , <a href="#">68</a> , <a href="#">113</a>
Signal Cable	<a href="#">24</a> , <a href="#">27</a>
Steinhart and Hart equation	<a href="#">8</a> , <a href="#">68</a> , <a href="#">72</a>
Surface	<a href="#">1</a> , <a href="#">I-III</a> , <a href="#">1</a> , <a href="#">2</a> , <a href="#">5</a> , <a href="#">6</a> , <a href="#">10-12</a> , <a href="#">16-21</a> , <a href="#">26</a> , <a href="#">27</a> , <a href="#">30-32</a> , <a href="#">35</a> , <a href="#">38</a> , <a href="#">42</a> , <a href="#">47</a> , <a href="#">48</a> , <a href="#">51</a> , <a href="#">53</a> , <a href="#">55</a> , <a href="#">57</a> , <a href="#">64</a> , <a href="#">67</a> , <a href="#">74</a> , <a href="#">93</a> , <a href="#">94</a> , <a href="#">106</a> , <a href="#">107</a> , <a href="#">114-117</a> , <a href="#">126</a> , <a href="#">130</a> , <a href="#">131</a> , <a href="#">133</a> , <a href="#">134</a> , <a href="#">136</a> , <a href="#">140</a> , <a href="#">141</a> , <a href="#">143</a> , <a href="#">154</a> , <a href="#">173</a>
Temperature	<a href="#">8-12</a> , <a href="#">14</a> , <a href="#">15</a> , <a href="#">24-27</a> , <a href="#">30-33</a> , <a href="#">40</a> , <a href="#">46</a> , <a href="#">51</a> , <a href="#">53-55</a> , <a href="#">62</a> , <a href="#">67-72</a> , <a href="#">74</a> , <a href="#">89-97</a> , <a href="#">99-112</a> , <a href="#">151</a> , <a href="#">154</a> , <a href="#">160</a> , <a href="#">170</a>
Time	
absolute time	<a href="#">13</a> , <a href="#">15</a>
averaging time	<a href="#">8</a>
integration time	<a href="#">15</a> , <a href="#">45</a> , <a href="#">61</a>
national time standard	<a href="#">14</a>
Network Time Protocol (NTP)	<a href="#">15</a>
observation time	<a href="#">56</a>
response time	<a href="#">8</a> , <a href="#">23</a> , <a href="#">89-91</a> , <a href="#">93</a> , <a href="#">95</a> , <a href="#">97</a> , <a href="#">98</a> , <a href="#">102</a> , <a href="#">104</a> , <a href="#">106</a> , <a href="#">107</a> , <a href="#">111</a>
settling time	<a href="#">44</a> , <a href="#">45</a> , <a href="#">96</a> , <a href="#">105</a>
solar time	<a href="#">73</a> , <a href="#">167</a> , <a href="#">168</a> , <a href="#">170</a>
time delay	<a href="#">14</a>
time period	<a href="#">III</a> , <a href="#">18</a> , <a href="#">23</a> , <a href="#">39</a> , <a href="#">57</a> , <a href="#">60</a>
time signal	<a href="#">14</a>
time stamp	<a href="#">50</a> , <a href="#">56</a> , <a href="#">73</a>
time-synchronization	<a href="#">14</a>
Tracker	
active	<a href="#">36</a> , <a href="#">40</a> , <a href="#">41</a> , <a href="#">49</a>
active eye	<a href="#">40</a>
passive	<a href="#">43</a> , <a href="#">50</a>
shade disk	<a href="#">34</a> , <a href="#">35</a>
sighting	<a href="#">21</a> , <a href="#">40</a> , <a href="#">101</a>
single-axis	<a href="#">34</a> , <a href="#">35</a> , <a href="#">40</a> , <a href="#">42</a>
solar pointing	<a href="#">41</a> , <a href="#">43</a> , <a href="#">54</a> , <a href="#">61</a> , <a href="#">100</a>
solar tracking	<a href="#">5</a> , <a href="#">31</a> , <a href="#">40-43</a> , <a href="#">73</a> , <a href="#">150</a>
synchronous motor	<a href="#">34</a> , <a href="#">36</a> , <a href="#">40-43</a>
two-axes	<a href="#">35</a>
Uncertainty	<a href="#">9-15</a> , <a href="#">30</a> , <a href="#">43</a> , <a href="#">44</a> , <a href="#">53</a> , <a href="#">54</a> , <a href="#">57</a> , <a href="#">60</a> , <a href="#">63-65</a> , <a href="#">67</a> , <a href="#">70</a> , <a href="#">73</a> , <a href="#">101</a> , <a href="#">129</a> , <a href="#">135</a> , <a href="#">136</a> , <a href="#">151</a> , <a href="#">152</a> , <a href="#">158-162</a> , <a href="#">164</a> , <a href="#">165</a>
Wavelength	<a href="#">30</a> , <a href="#">54</a> , <a href="#">55</a> , <a href="#">57</a> , <a href="#">59-63</a> , <a href="#">67</a> , <a href="#">91</a> , <a href="#">107</a> , <a href="#">108</a> , <a href="#">111</a>
Wind	<a href="#">9</a> , <a href="#">14</a> , <a href="#">24-27</a> , <a href="#">33</a> , <a href="#">96</a> , <a href="#">100</a>
Zenith angle	<a href="#">62</a> , <a href="#">67</a> , <a href="#">73</a> , <a href="#">91</a> , <a href="#">97</a> , <a href="#">115</a> , <a href="#">130</a> , <a href="#">131</a> , <a href="#">133</a> , <a href="#">134</a> , <a href="#">136</a> , <a href="#">171</a>