



Xpert² Data Logger

Operations and Maintenance Manual

Part No. 8800-1173

Rev 3.22

February 5, 2018

Sutron, Corporation
22400 Davis Drive
Sterling, Virginia 20164

TEL: (703) 406-2800





FAX: (703) 406-2801



























WEB: <http://www.sutron.com/>

























Table of Contents















CHAPTER 1: INTRODUCTION.....	1
FEATURES.....	2
Key Features	2
Features.....	2
HIGHLIGHTS	3
EzSetup and Graphical Setup – The Key to Flexibility	3
I/O Modules – The Key to Expansion	3
DLLs – The Key to Modularity	3
PRODUCT DESCRIPTION.....	4
Models	5
CHAPTER 2: GETTING STARTED	7
UNPACKING.....	8
Standard Items	8
Common Optional Items.....	8
Other Optional Items	8
INITIAL CHECKOUT	9
Powering Up	9
Adjust the Contrast (optional)	9
Verify Touchscreen and Display Work	9
Verify XTerm Works.....	9
Verify I/O Modules Work	9
Optional SLL Library	10
PREPARING FOR SETUP.....	14
Analyze the System	14
Choosing the Right Block.....	14
SDI-12 Sensors over RS-485 port on an 8080-0000-3B.....	15
Redirecting SDI to COM9 on an 8080-0000-3B.....	15
CHAPTER 3: OPERATING THE XPERT	17
LOGGING IN.....	18
User Access	18
Tab Overview	18
MAIN TAB	19
Date/Time	19
Station Name	20
Station Status	20
Contrast.....	20
Battery Voltage.....	21
Logout.....	21
SETUP TAB	22
Tree overview	22
Coms (SSP/CL)	23
COMS (SSP/CL) Setup Menu	24
Coms Configuration Settings	28
EzSetup Measurements.....	35
Measurement Schedules.....	36
Sensor Configuration	37
Graphical Setup	41
I/O Modules.....	42
Naming I/O Modules	42
Resetting I/O Modules	43
LAN Settings	43
Crossover Connections	44

LAN Settings - Transmit.....	44
Log Files.....	47
Log Properties.....	47
Satlink.....	49
Self-Timed Dialog.....	51
Append Lat/Lon.....	54
Self-Timed Test.....	55
Random Test.....	56
Satlink Status.....	57
Self-test.....	57
Setup File.....	58
New.....	59
Open.....	59
Save As.....	59
Append.....	60
SNTP.....	60
Users.....	60
SENSORS TAB.....	63
DATA TAB.....	65
LOG TAB.....	68
Column Labels.....	68
Selecting Log File.....	69
Navigating the Log.....	69
+Day, -Day.....	69
Find.....	69
Clearing the Log.....	69
Entering a NOTE.....	69
Export.....	70
STATUS TAB.....	72
USING STORAGE CARDS.....	74
Expand Log File Capabilites.....	74
Upload/Download Setups.....	75
Download log files.....	75
CHAPTER 4: GRAPHICAL SETUP DIAGRAMS.....	77
OVERVIEW.....	78
AN EXAMPLE SETUP DIAGRAM.....	79
Block Categories.....	79
Block Inputs and Outputs.....	79
Block Connectivity.....	80
Active Blocks and Push/Pull.....	80
Block Placement.....	81
Block Properties.....	81
CREATING A NEW SETUP DIAGRAM.....	83
Adding a Sensor Using the Wizard.....	83
Adding Additional Blocks.....	84
Changing Block Properties.....	86
MODIFYING A SETUP DIAGRAM.....	89
Wiring and Unwiring.....	89
Deleting a Block.....	91
Deleting Multiple Blocks.....	91
Insert A Block.....	92
CHAPTER 5: EXAMPLE SETUPS.....	95
EZSETUP FOR A STREAM GAUGING STATION.....	96
GRAPHICAL SETUP TO COMPUTE DAILY MIN/MAX.....	101
CHAPTER 6: OPERATION WITH A PC RUNNING XTERM.....	103

INTRODUCTION.....	104
Installing XTerm.....	104
Automatic Detection of Xperts on a Network	106
SSP Settings.....	106
Redirector Settings	107
Preparing the Xpert to work with XTerm	108
Operating XTerm.....	108
File Transfer	110
Process List Folder.....	111
Set Clock	112
Connect.....	113
Upgrade	113
Web Server	113
Auto Update.....	113
Station Operations	113
Startup.....	113
Shutdown	113
Reboot.....	114
FireWalls	114
Configuring the PC modem for use with Xterm	115
Status and Rx, Tx, Xp, Err indicators	115
Special Command Line Options	117
CHAPTER 7: INSTALLATION.....	121
STEPS TO INSTALL AN XPERT	122
USING COM PORTS.....	125
Overview	125
Pin-out information.....	125
Jumper Settings.....	127
Maximum Current Draw from Com Port Pin 9	128
Xpert Com 1 - 4	128
Xpert com 5 - 9 (Optional Quad Serial board).....	129
Switched power settings.....	129
CHAPTER 8: MAINTENANCE AND TROUBLESHOOTING	131
COMMON MAINTENANCE AND TROUBLESHOOTING.....	132
Calibrate the Touchscreen	132
Skip the autoexec.bat	132
Unit missing functionality	132
Xterm has a White screen or Black Screen.....	133
Adjust the contrast.....	133
Replace the Internal Battery every 5 years	133
Cleaning Instructions	134
Fuses	134
APPENDIX A: SETUP BLOCKS	135
INTRODUCTION.....	136
SENSOR BLOCKS.....	137
 Air Temperature Sensor (AirTemp).....	137
 Air Temperature/Relative Humidity (AT/RH).....	139
 Analog (ADC).....	140
 Barometric Pressure (BP)	146

	BEI Absolute Encoder (BEIEnc)	147
	Binary Input (BinIn)	148
	Binary Input – All Channels (BinInAllChan)	150
	Bridge Resistance (Bridge)	152
	CapRain (CapRain).....	153
	Constant (ConstIn)	155
	CS107 Temperature Sensor (CS107Temp).....	159
	Frequency (Freq).....	161
	Fuel Moisture (FM)	163
	GetTag	164
	GillWind (Gill Wind Sensor).....	165
	Heat Flux (HeatFlux)	167
	Internal Battery (IntBat).....	170
	Log Input.....	171
	ML2x Soil Moisture Sensor (ML2x).....	172
	MRL 700 Radar Sensor (MRL700)	173
	Net Radiometer Sensors (NetRad)	175
	Airmar PB200/200WX (PB200)	178
	Platinum RTD (PlatRTD)	181
	Quadrature Shaft Encoder.....	183
	R.M. Young Wind Sensor (RMYoung)	184
	SDI-12.....	186
	SDI AquaTrak (SDIAqua)	187
	SE8500 (SE8500)	188
	Send Current Time (SendTime)	189
	Soil Moisture (SoilM)	190

	Soil Temperature (SoilTemp).....	192
	Solar Radiation (SolRad)	193
	Submersible Pressure Transducer (SubPres)	195
	Tipping Bucket Sensor (Precip).....	196
	Volt Meter (VoltMeter).....	198
	Vibrating Wire (VWire)	199
PROCESSING BLOCKS		200
	Alarm	200
	Accumulator (Accum).....	202
	Average (Average).....	203
	Bool (Boolean).....	205
	CS625 Water Content Reflectometer (CS625WCR)	206
	Dew Point (DewPt).....	208
	DQAP (Quality-Controlled Average)	209
	Interpolate (Interpolate)	211
	Georgia Pacific Sampler (GPSmpl)	213
	Measure (Measure)	214
	Minimum/Maximum (MinMax)	215
	Moving Average (MovingAverage).....	216
	Polynomial (Poly).....	217
	PtCtrl (Point Control).....	218
	Quality Control (QC)	220
	Set Point Control (SetPoint).....	221
	Solar Radiation Accumulator (SRAcc)	222
	Vector Average (VectAvg)	224
	Wave Processor (WavProc).....	226

	XY Function (XYFunc)	231
	LOGGING BLOCKS	232
	Log	232
	LogField	234
	LogRec	236
	WebLog	239
	TELEMETRY BLOCKS	240
	Coms Tag	240
	Random Group (RndGroup)	241
	LAN Telemetry Tag	243
	Random Parameter (Random)	246
	Self-Timed Parameter (SelfTimed)	247
	OUTPUT BLOCKS	250
	Binary Out (BinOut)	250
	Pulse Out (PulseOut)	251
	Send Tag	252
	MISCELLANEOUS BLOCKS	253
	Display (Display)	253
	Field Variable (FieldVar)	254
APPENDIX B: UPDATING THE FIRMWARE		257
	UPDATING THE FIRMWARE	258
	Serial/Ethernet Upgrade	258
	Customizing a Serial/Ethernet Upgrade	259
	Storage Card Upgrade (SD or USB)	262
	Customizing a Storage Card Upgrade	262
	Manual Component Upgrade	263
	Upgrade the Boot Loader	263
	Upgrade the Kernel	263
	Upgrade the Application	264
APPENDIX C: I/O MODULES		265
	ANALOG I/O MODULE – 8080-0003	266
	Features	266
	Specifications	267
	Operational States	268
	Running	268
	Stopped	268
	Inputs/Outputs	268

Inputs	268
Outputs.....	268
Analog Measurements	268
Accuracy.....	269
Example Configurations Using the 8080-0003 Analog I/O Module	270
ANALOG I/O MODULE – 8080-0007	271
Features.....	271
Transient Protection Installation Note	271
Specifications.....	272
Example Configurations Using the 8080-0007 Analog I/O Module	273
DIGITAL I/O MODULE – 8080-0002.....	274
Inputs	275
Outputs	276
APPENDIX D: SPECIFICATIONS.....	277
Basic Unit with Display – 8080-0000-1B, 8080-0000-2B, and 8080-0000-3B.....	278
Basic Unit without Display – 8080-0001-1B.....	278
I ² C Modules	278
RS232 Modules	278
Speech Modem	278
LOS Radio	279
Satlink Transmitter.....	279
APPENDIX E: SOFTWARE DEVELOPMENT KIT (SDK).....	281
OVERVIEW	282
APPENDIX F: CREATING CUSTOM VOICE FILES	283
OVERVIEW	284
APPENDIX G: AUTOEXEC.BAT AND REMOTE.EXE	285
AUTOEXEC.BAT	286
REMOTE.EXE	287
ABOUT Command Example	296
Get Command Example	297
INFO command Example	298
MAIL Command Example.....	298
MEASURE/SHOW Command Example	298
PASSTHRU Command Example.....	299
RECORDING Command Example.....	299
SET Command Example.....	299
SHUTDOWN Command Example	300
STARTUP Command Example	300
STATION Command Example.....	300
STATUS Command Example.....	300
UPGRADE Command Example	300
YMODEM Command Example.....	300
APPENDIX H: TRANSMISSION FORMATS.....	301
ASCII Column Format	301
Handar Format.....	301
NFDRS and NIFC Formats	302
Pseudobinary Formats	303
Pseudobinary B (Interleaved “Bin Int”, and Non-Interleaved “Bin Non-Int”).....	303
Pseudobinary-C Format	304
Pseudobinary-D Format	306
Six-Bit Binary Encoded Format.....	307
SHEF and SHEFFIX	308
NOS	309

NFDRS	309
INSAT	310
BUFR.....	311
BUFR Content Options	314
APPENDIX I: DIMENSIONS	315
XPERT2 DATA LOGGER	316
IO MODULES	318
XPERT MODEM.....	319

Chapter 1: Introduction

FEATURES

Sutron's Xpert is designed to be the heart of a wide range of remote monitoring and control systems. The Xpert is a highly modular design that is scalable to handle simple to complex requirements.

Key Features

Intuitive, EzSetup and a graphical block-oriented setup.

Unlimited expansion with I/O Modules.

Software extensibility with DLL libraries.

Features

USB and SD card support for log memory expansion.

Multiple, independent log files. Changes to setup do not affect logged data.

Modular design – you build the logger from modules offered by Sutron.

Expandable – additional modules can be added as needed.

Scalable – handles simple as well as complex sites.

Low power consumption – sleep modes with low quiescent power, low operating power.

Battery operated – each module operates off of 9.5 to 16 VDC.

Wide temperature operation – -40 to +60C.

High reliability and robust – no fuses, fault tolerant, lightning protection.

Multiple telemetry – can add telephone, LOS Radio, GOES, METOESAT telemetry.

Plug-n-play ease of setup – the system is setup with ease. Install a new module, and the system automatically detects it and allows it to be configured for operation.

Flexible measuring and recording – The setup allows separate measuring schedules for data as well as individual recording intervals.

Open design – the system will operate with sensors and modules manufactured by others.

Takes measurements from low cost sensors.

High-speed data transfers – data downloads to PC at 115k baud.

Time accuracy of ten seconds per month over full temperature range.

HIGHLIGHTS

EzSetup and Graphical Setup – The Key to Flexibility

A unique part of the design is the ability to use the EzSetup and/or the graphical block-oriented setup. Many simple measurements are quickly setup using EzSetup, for even more flexibility the graphical setup blocks of various types are connected together to graphically represent data flow from all sensors, with data flowing from left to right. An example EzSetup is shown below on the left and a graphical setup is shown below on the right.

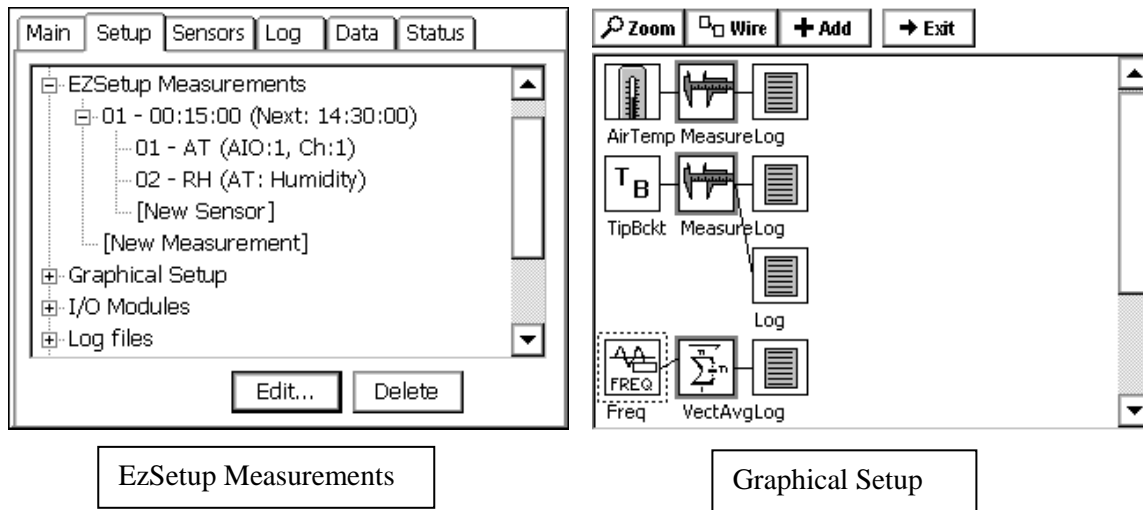

I/O Modules – The Key to Expansion

The Xpert epitomizes the concept of expandability. By itself, the Xpert functions as a highly capable SDI-12 v1.3 compliant logger. To add a sensor with an analog or digital output, simply connect a Sutron I/O module through the unit's I²C port. Need to add more sensors than one module will support? Simply stack additional modules onto the first. The Xpert supports a nearly unlimited number of analog and digital I/O modules, so running out of I/O is never an issue.

DLLs – The Key to Modularity

The Xpert software is modular and utilizes Windows DLLs (Dynamic Linked Libraries). DLLs are additional software components that can be added to the system at any time without having to update the main software. This makes adding a new feature to the Xpert that was not available when the unit was purchased easy - simply download the new DLL from the Sutron web page, and send it across to the Xpert. This might be done, for example, to add support for a new sensor, or to add some newly released communication capability to the unit. Some customers can even create their own DLLs using Microsoft Visual C++ and a Software Development Kit (SDK) provided by Sutron.

PRODUCT DESCRIPTION

The Xpert data acquisition platform is based on a 32 bit microprocessor, the Microsoft Windows CE operated system, and a touch-sensitive graphical display (optional). The Xpert comes in two models: one with a touch screen and one without a touch screen. Sensors are added to the system via the SDI-12 port or via I/O modules that plug into the I²C port. For data retrieval, the Xpert comes with up to four serial ports for connection to satellite, modem, a PC, the Internet, etc. In addition, every unit comes with a minimum thirty-two megabytes of flash disk for data and program storage and thirty-two megabytes of RAM for program execution. All units support expanding storage up to 2GB via the SD card slot. All inputs to the systems can be found at the bottom side of the unit, as shown below. The Xpert requires power from an external battery of 9.5-16 VDC.

All the functionality in the Xpert can be accessed through the touch screen of the device. The screen can be activated either with the special stylus that came with the system or with a finger. All the operations necessary to operate the unit can be done via the graphical interface on the touch screen. For units without a touch screen, the windows based program Xterm.exe provides the necessary screens for operation.

Xpert (Shown with display and 4 additional com ports)



Xpert (with display and 4 additional com ports)



Xpert Connector Panel

Models

The Xpert comes in several different models. The available models include:

- 8080-0000-1B Xpert with Display and Backlight
- 8080-0000-2B Xpert with Display and Backlight and 8 Serial ports
- 8080-0000-3B Xpert with Display and Backlight, 7 RS-232 and 1 RS-485 serial port
- 8080-0001-1B Xpert without Display
- 8080-0001-2B Xpert without Display, with 8 Serial ports

In addition, the following are available as add-ons to the system.

Xpert Telemetry Modules

- 8080-0005-1 Speech modem
- SL2-G312-1 Satellite Transmitter

Xpert I/O Modules

- 8080-0002-1 Xpert, Digital I/O, 8 Channels
- 8080-0002-4 Xpert, Digital I/O, 8 Channels with Surge Protection and 24" Cable
- 8080-0003-1 Xpert, Precision Analog I/O, 6 Channels
- 8080-0003-3 Xpert, Precision Analog I/O, 6 Channels with Surge Protection and 24" Cable
- 8080-0007-1 Xpert, 10 channel, 16 bit Analog I/O

Termination Boards

- 6461-1239-1T RS232 Surge Protection
- 6461-1240-1T Phone Surge Protection
- 6461-1241-1T SDI Surge Protection
- 6461-1242-1T Power Protection

Chapter 2: Getting Started

UNPACKING

Carefully unpack the Xpert and other components that came with the system. Note that some items come standard with every Xpert while other items are optional.

Standard Items

The following items come with every Xpert that is shipped:

- One Xpert.
- One stylus for use with the touch screen (only with models that have a touch screen).
- One CDROM containing PC Utilities and manuals
- One DB9 M-F serial cable.

Common Optional Items

The next items – sold separately, either because they can be shared between systems or because not all installations require them – are often also included:

- A DB9 M-F serial cable for I/O Modules.
- One or more Analog I/O modules.
- One or more Digital I/O modules.
- One or more termination boards.
- System enclosure box.
- Lead acid battery.
- Solar panel regulator.

Other Optional Items

One or more of the following might also be included:

- Analog, digital or SDI-12 sensors.
- Modem, Line-of-Site Radio or Satellite transmitter.
- Antenna.

INITIAL CHECKOUT

Powering Up

To start the Xpert, connect power (9.5 to 16 VDC) to the G and + power connections on the left side of the terminal strip (labeled PWR). When power is applied, the Xpert will first display a startup screen and then, if configured to do so, display the login screen. Note: do not touch the screen during power up as this may cause the Xpert to run one of its special power-up routines.

Adjust the Contrast (optional)

On the Xpert, if the login screen is not readable the contrast may need adjustment. Try tapping the display in the upper right corner to darken the display or tap in the lower right corner to lighten it. Wait at least 2 seconds each time you tap the display for the adjustment to take effect. If tapping the display has no effect, the application program is probably not running. Refer to the troubleshooting section for help to diagnose the problem.

Verify Touchscreen and Display Work

To verify the touchscreen and display work, press the Setup Access button on the login screen. Then press the button labeled next to the station name. Use the stylus, enter a name for the station and press OK. If the Xpert does not respond properly to the stylus, the touchscreen may need calibration. Refer to the troubleshooting section for help to recalibrate the touchscreen.

Verify XTerm Works

XTerm is a program that connects your PC to the Xpert. Using XTerm you will be able to setup and test an Xpert or Xpert without display. See Chapter 6 for the details on how to install and run XTerm.

Verify I/O Modules Work

If you purchased separate I/O modules with the Xpert, connect the I/O modules together, and then using a 9-pin cable, connect them to the I²C port on the Xpert. You can connect the cable to either side of the I/O modules.

Once the modules have been connected, use the stylus (or PC mouse if using XTerm) to select the tab labeled *Setup*. If you don't see it as one of the tabs, use the scroll buttons to the right of the tabs to bring it into view. Now press the + in front of the I/O Module branch. You will now see a list of the modules you have connected to the system. If any have the same name, then the module number will have to be changed in order to differentiate them. Changing the module number is described in the [Naming I/O Modules](#) section. If you do not see the + in front of I/O Modules, the system was not able to detect any I/O modules. Check your cable to the I/O modules. Make sure you are connected to the I²C port. Refer to the troubleshooting section for help if you cannot get the system to find the I/O modules.

The initial checkout of the Xpert is complete.

Optional SLL Library

Sutron has written several custom sll's for various customers. These sll's are provided in all upgrades for convenience. While most of these sll's are specific to certain sensors, special processing, etc., other customers may find a use for them. Listed below are all the extra-slls that are provided in the standard upgrade zip file, along with a short description of their purpose. If you find that one of these sll's may be of some use to your application, and you want more information, please contact Customer Service.

NOTE: In some of these sll's, a serial interface is needed. In most cases, the blocks that are created, or setup tab entries that are made, will need to have full control of the com port. This is accomplished by leaving the com port set to "NONE" in the Coms (SSP/CL) branch under the setup tab. Refer to the specific documentation for the sll to see if the com port is to be defined in Coms (SSP/CL) or not.

Aanderaa.sll	The purpose of this SLL is to receive data from an Aanderaa logger, but may also be used to parse any space or comma separated numeric data using an RS-232 com port.
AirGap.sll	The purpose of this SLL is to allow users to connect a MIROS Air Gap water level sensor to one of the COM ports.
AlohaHazmat.sll	Formats and outputs messages specific to the Aloha Hazmat PC desktop software via com port. Supports Aloha weather station.
ASWell.sll	This SLL implements a custom processing block to support Alamosa Salvage Well control.
ATDisplay.sll	The purpose of this SLL is to allow users to display information from an Xpert/Xlite LOG file on an Adaptive Technologies display device. Adaptive Technologies offers a variety of indoor and outdoor displays that can be used to make information in an Xpert easily accessible to the public.
AtoN.sll	Adds ability to select sensor values for inclusion into an AIS Message 8 broadcast over an AtoN (Aid to Navigation) radio, e.g., the Mando 3 by Alltek.
AWOS.sll	This SLL implements custom processing blocks and reporting mechanisms to support AWOS weather stations.
CoOp.sll	This SLL implements custom sensor and processing blocks to support CO-OP weather stations. Sensors include OTT Rain gauge and Stevens Soil moisture probe. Processing block for the Geonor Rain gauge is also included.

DGH.sll	The purpose of this SLL is to connect any DGH output module, typically a 4-20mA or 0-5V, to a com port. The DGH module simply needs to respond to the following output string: \$1AO+0yyyy.yy followed by a CR. Refer to App note 33 for details on use of this block.
Evapotran.sll	The purpose of this SLL is to add an Output block to weather stations that will calculate daily potential evapotranspiration (ET0)
GPRS.sll	This SLL adds support for GPRS cell modem communications, both transmissions and incoming message processing.
GPRS232.sll	This SLL provides a general purpose RS-232 communications block, intended to enable measurement of a variety of RS-232 sensors.
IMD.sll	This SLL implements custom reporting functionality required by IMD.
IECModbus.sll	This SLL extends the capabilities of the modbus sll to work with a device built by Applied Systems Engineering to interface to an IEC-104 network.
Iridium.sll	This SLL adds support for Iridium cell modem communications, both transmissions and incoming message processing.
LCRAPLCDriver.sll	The purpose of this SLL is to connect a serial input PLC to one of the COM ports. The PLC is used to provide remote output of the headwater and tailwater levels in reservoirs
LCRASerialDisplay.sll	The purpose of this SLL is to connect a two-line Adaptive Alpha™ display to one of the COM ports. The purpose of the display is to provide remote output of the headwater and tailwater levels in reservoirs.
ManualEntry.sll	This SLL adds a block that allows the user to enter observed data measurements manually.
Modbus.sll	The purpose of this SLL is to add the ability to communicate via modbus to the Xpert/9210. For more information, see the document “Xpert Modbus SLL User Manual”, available under separate cover.
NIFC.sll	The purpose of this SLL is to provide the necessary blocks to connect sensors used in Fire Weather applications.

NOS.sll	This SLL implements a reporting mechanism for NOS stations using the user login and a data file to determine the report contents. In addition, this sll adds average and measure blocks that allow data time-stamps to be centered on the interval.
Pflow.sll	This SLL implements custom pump flow rate and duration calculations.
PPP.sll	This SLL adds support for PPP and SLIP protocols, as well as support for SSP messaging over related devices.
PPSaver.sll	This SLL implements custom power-saving measurement and communication algorithms for Poland Power project.
QFE.sll	This SLL adds a sensor block used to calculate standard atmosphere based on elevation.
QuadW.sll	This SLL adds the QuadW sensor block, used to measure a quadrature sensor connected to a Weeder Tech WTDIN-M module. The WTDIN-M module is capable of tracking quadrature at much faster rates than the normal Quad block in the Xpert. A single QuadW block reads all four channels of the Weeder Tech module. The WTDIN-M will retain its measurement of position until power is removed. For more information, see the document, "Xpert QuadW SLL User Manual.doc", available separately.
RDI.sll	This SLL Implements RDI protocol.
Relay.sll	This SLL contains a block intended to control a relay. The block will set a digital output for a specified time duration, and then clear the output.
RS485SDI.sll	This SLL enables SDI over an installed RS485 com port, if any (Xperts may be ordered/upgraded to support RS485 via a change to internal hardware; 9210s normally support RS485 on COM4, and may also have internal hardware change for other ports). NOTE: for more information on using SDI-12 over RS485, see the 9210B user manual discussion of this SLL.
SR50.sll	This SLL enables measurement of SR50 ultrasonic height gauge.
SRP.sll	This SLL works with the 9210 only, prompting the user to download data after inserting a storage card.
TerminalServer.sll	This SLL adds commands to the remote command line interface based on the user login.

VibratingWire.sll	The purpose of this SLL is to allow users to connect a Canary Systems VW DSP serial interface to one of the COM ports on a Sutron Xpert or XLite (Model 9210) data logger. The VW DSP can be used by itself to measure temperature and pressure from two vibrating wire sensors (e.g. those made by Geokon). The VW DSP can also be wired to one or more Canary Systems MiniMuxes, providing the capability to measure from additional sensors in increments of 16 or 32 per MiniMux.
VWireMux.sll	The purpose of this SLL is to allow user to log multiple pressure transducer and optional thermistor readings by using a Canary Systems MiniMux™ digital switch.

PREPARING FOR SETUP

This section discusses various issues important to know before setting up the Xpert.

Analyze the System

Chapters 3 and 4 describe all the elements that go into setting up the Xpert. Before jumping in to setting up the unit, it's useful to think about the nature of the problem the Xpert is being used to solve. The following questions can help guide that thinking:

What data needs to be collected?

What sensors will give this data?

What is the raw output of these sensors, DC voltage, AC voltage, frequency, Serial, etc.?

Can the built-in I/O handle all of these sensors, or are additional modules needed?

How often should this data be collected?

What processing is needed to convert this raw data into a meaningful value? Is there already a block defined to do this processing or is a generic input needed?

Where does the data need to go once it is processed, to a Satlink, a modem, a LOS radio, a serial device (PC, display, printer) or just to a log?

Chapter 5 describes several example setups that can help get you started in configuring the Xpert. If you need more help, don't hesitate to call our Customer Service department. They've worked with many data collection and reporting scenarios, and can help you set up your system just as you need.

Choosing the Right Block

As Chapters 3, 4 and 5 will reveal, the Xpert setup is based on "blocks" that perform a specific function on data collected from a sensor, or from another block. The Xpert's *Graphical Setup* provides an interface to connect and configure these blocks. The Xpert's *EzSetup* interface also uses blocks, though they are hidden from the user's view.

Here's a simple map of sensor types to block types:

Sensor Type	Sensor Block
DC voltage output	VoltMeter or ADC
Resistance	ADC
Frequency output	Counter or Frequency
SDI-12 output	SDI-12
RS-232/RS485 output	RS232 (GPRS232.sll) or Basic Sensor

See Appendix A for a listing of all the different types of blocks available in the system.

The most common measurement type is an analog measurement, i.e., either a voltage or resistance. Many analog sensors simply specify a +5 V excitation voltage and provide a slope and offset. The ADC block provides all the properties needed to make this measurement.

For the most accurate analog reading, use the ADC block's *Double Volts* option, and multiply the given slope by 5. *Double Volts* will always return a ratio of REF / reading, meaning it will return a value between 0 and 1, since the slope for a +5 REF assumes an output of 0 – 5. Multiplying the given slope by 5 will return the correctly scaled value. Using *Double Volts* will

require 2 analog channels. If the system is running low on analog inputs, the *Voltage* reading could be used, if you multiply the given slope by 2 (since Vref is 2.5).

What if you don't see a block that appears to do what you need? Starting with version 2.2, the Xpert supports Xpert Basic, a programming language with which you can write your own blocks, and other custom processing. Refer to the Xpert Basic Users Manual for more details.

SDI-12 Sensors over RS-485 port on an 8080-0000-3B

The 8080-0000-3B has the ability to use RS-485 for SDI-12 sensors that support SDI-12 over RS-485 interfaces (which the 3B provides via the COM9 connector).

Differential SDI-12 is not a defined standard. It is a low power modification of an RS-485 interface. It overcomes the cable limitation of SDI-12 since transmitted data is not referenced to the power supply ground. It does not utilize a power consuming DC termination resistor. The data signaling rate and protocol conform to SDI-12 standards. The specification can be obtained at <http://www.sdi-12.org/>

Four wires are needed to use the differential SDI-12 interface, two for power and two for data. Wire as follows:

SENSOR	8080-0000-3B
GND	COM9 pin 5
+12V in	COM9 pin 9 with J4 configured for +12V
RS-485(A)	COM9 pin 3 (idles high)
RS-485(B)	COM9 pin 2 (idles low) same polarity as SDI-12 data line

NOTE: Since this is not a defined standard, the labeling of the data lines is also not standardized. The A and B above reflect the naming utilized in the RS485 specification. No harm will be caused by reversing the data lines, but there will be no communication.

When no SDI-12 communication is occurring, no device is driving the data lines, but once the port has been opened for the initial communication, the Xpert applies a slight bias current to maintain the idle condition. If the sensor is expecting a stronger idle bias, then that could be provided with external resistors. Stronger biasing can be achieved by placing a 100K resistor from the COM9 pin2 data line to GND and another 100K resistor from the COM9 pin3 data line to +12V.

NOTE: In this case, the com port settings in the Coms (SSP/CL) section of setup should be left as none. Coms (SSP/CL) is strictly for configuring SSP and Command Line communication devices (e.g., Modem, Voice Modem, Radio, SSP, and Direct).

Redirecting SDI to COM9 on an 8080-0000-3B

To redirect SDI-12 to COM9, the XPERT.EXE program must be run with the /SDI COM9: command line parameter. To do this, edit the autoexec.bat to look like this:

```
\flash disk\remote.exe com1:115200  
\flash disk\xpert.exe /SDI COM9:
```

Note: Be sure to include the colon after the 9.

NOTE: Once the Xpert application has been configured this way, ALL SDI-12 sensors will use COM9 for communicating.

Chapter 3: Operating the Xpert

This chapter describes how to operate the Xpert using its graphical user interface (GUI). If the Xpert has a touch screen display, the GUI is available on the front of the Xpert. If the Xpert does not have a touch screen, then a PC running XTerm must be used to get access to the GUI. See chapter 6 for instructions on how to install and run XTerm.

LOGGING IN

User Access

After connecting with Xterm, two choices of access are available – Retrieval and Setup. Each succeeding level provides all the privileges of the preceding level. Therefore, users logging in under Setup Access can retrieve data, but users logging in under Retrieval Access cannot access the system setup. Multiple usernames/passwords (accounts) are allowed for these levels. If no users are added for a particular level, then that level can be entered without a password.

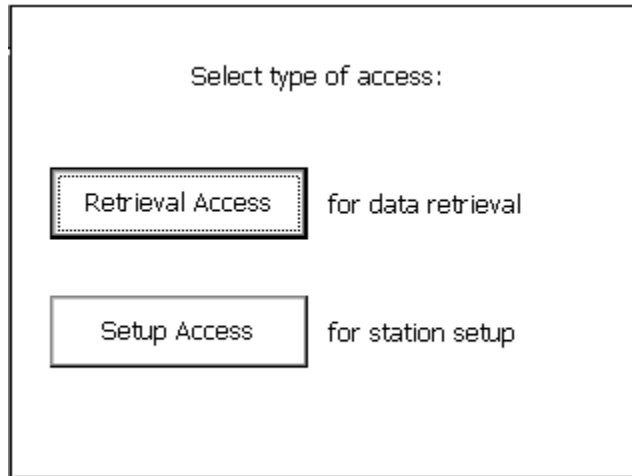

Logging into the unit causes a note to be sent to the system log, recording the username and time of the login. The user accounts are maintained on the *Setup* tab under *Users*. Access to this tab is available to the Setup group only.

Press the Logout button on the Main tab to logout. NOTE: If using Xterm, Logout does not close Xterm, it just logs you out of the system.

The contrast setting for the Xpert display can be changed from the login dialog (temperature extremes affect contrast considerably and can render the display unreadable without adjustment). Invisible “buttons” exist in the upper and lower right corners of the screen. Each button is about an inch or so square. Pressing the upper right button increases the contrast setting, while pressing the lower right button decreases the contrast setting.

Tab Overview

To see all available tabs, login using the Setup Access button. Many tabs are available, clicking one of these tabs will bring it to the foreground for viewing. Of all the available tabs, the *SETUP* tab is used primarily to set the system up, the other tabs simply provide station status or details on collected data.

MAIN TAB

After logging in, the display should look similar to the one shown below, with the *MAIN* tab in the foreground. The *MAIN* tab is where information about the station status is primarily displayed.

Across the top of the screen is a text label that identifies the platform. Under this label are a series of tabs like the tabs on file folders. These tabs are used to provide quick access to the different functions.

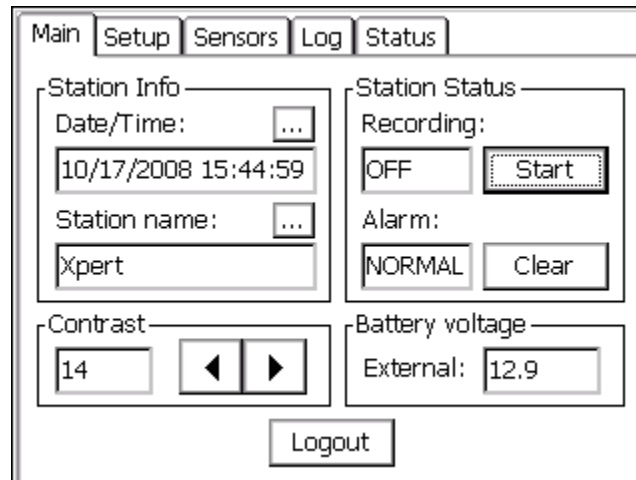

The screen image below reveals tabs for *Main*, *Setup*, *Sensors*, *Data*, *Log* and *Status*. The actual tabs displayed on a system depend on the DLLs installed in the system and the access mode selected at login.

Date/Time

Date and/or time are used to perform scheduled functions. The internal clock will keep time accurate to ten seconds a month over the temperature range of -40 to +60 C. The date and time is maintained even after power is removed from the system by a lithium coin-cell battery. NOTE: On Satlink systems, with self-timed transmissions enabled, the system will synchronize its clock to the Satlink periodically, maintaining higher clock accuracy.

To change the date or time, press the button to bring up the Set Date/Time window shown below. Use the stylus or the << or >> buttons to move from one field to the next, and use the numbers in the virtual keypad to enter the new value. The values in the field can also be incremented or decremented via the + and - buttons.

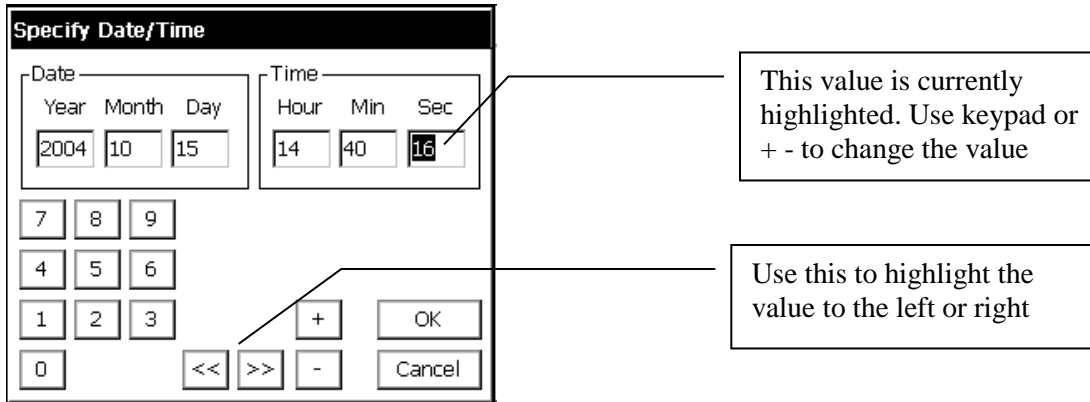

Station Name

The station name is the general-purpose identifier for the station. It can be up to 16 alphanumeric characters. This name does not need to be the same as the GOES/METEOSAT identifier, but is used when connecting into a SSP system as the slave station name. When communicating to other stations, or a base station (PCBASE, XCONNECT), this name is case-sensitive, therefore it should be entered in UPPERCASE letters to avoid confusion.

NOTE: If the station name is changed, power must be cycled for SSP communications to use the new name. When the Xpert is started, it will try to load a setup file with the same name as the station name.

Station Status

The Station Status box indicates both the recording and alarms states, and contains buttons to affect those states.

The recording status box indicates the current state of recording (i.e., whether measurements are being made and logged). This box also indicates whether transmissions are enabled when recording is on. When recording is off, the status box reads "OFF" and the button to its right is labeled *Start*. Pushing *Start* will start recording, changing the status box to read "ON" (or "ON+TX", if transmissions have been enabled in the setup). The *Start* button then changes to read *Stop*.

The alarm status box indicates the current alarm state. The current alarm state may be NORMAL, ALARM, or ALERT. The Clear button is used to clear the current state (a clear during ALERT transmissions the system to ALARM, while a clear during ALARM transmissions the system to NORMAL). See *Coms (SSP/CL)* under *Setup* for more information.

Contrast

The contrast setting for the Xpert touchscreen display can be adjusted using the "<" and ">" buttons. The ">" button increases the contrast while the "<" button decreases it.

Note: This contrast adjustment has no effect on the XTerm program, adjusting it from Xterm will affect the LCD though.

Battery Voltage

The Battery Voltage status area displays the supply voltage next 'Ext:'. This value is measured and updated every 5 minutes.

The internal lithium clock battery should be replaced every 5 years. This battery is only used for preserving date and time when power is removed from the system. If on power up, the system detects that it has lost the date and time, it will set the date to 1/1/1984. No other operating parameters are preserved by this battery. See Common Maintenance and troubleshooting for information on changing the battery.

Logout

Pressing *Logout* will re-display the login screen and turn off the display. You will need to touch the screen again to turn on the display.

If using Xterm, the connection to the unit is not shut down on a logout. Close XTerm by pressing the X in the upper right hand corner to ensure the remote system can go into its lowest power mode.

SETUP TAB

The setup tab allows for viewing and editing system settings. The items shown in the setup tab will vary depending on the configuration of the system and the version of the system software. Some standard entries are: *Graphical Setup*, *I/O Modules*, *Log Files*, *Self-test* and *Setup File*. Examples of entries that might also appear include: *Coms (SSP/CL)*, *EZSetup Measurements* and *Satlink*.

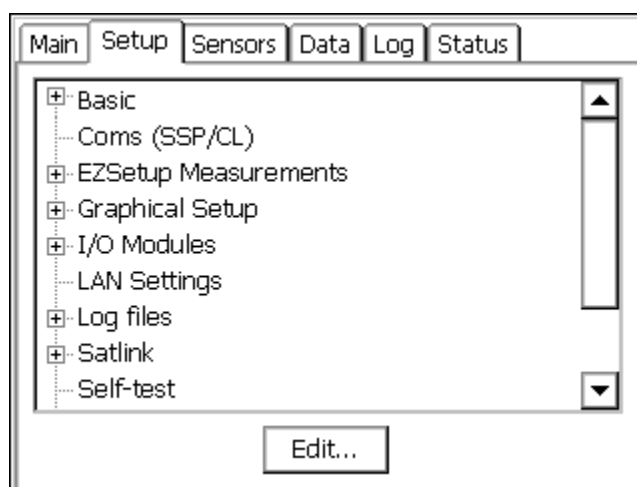

Tree overview

Items in the setup tab are displayed with branches that can be expanded or compressed by clicking the '+' or '-' next to the branch. This structure allows for displaying only as much information on the screen at one time as desired.

The following table gives a brief description of the purpose of each item. The sections following the table give more detail on each item.

<i>Tree Item</i>	<i>Description</i>
Basic	Used to compile and schedule basic programs. See the Xpert Basic SLL User's Manual for more information.
Coms (SSP/CL)	Used to configure SSP and Command Line communications (e.g., communications with Xconnect, PCBase, Xterm, Hyperterminal, etc.). This section is not used with most extra sll's that use com ports, unless the documentation for that sll says to use a specific connection in the Coms (SSP/CL) setup. Note: See Chapter 7 for coms pinouts and jumper settings.
EZSetup Measurements	Used to define simple (single input) measurements. Sensor measurements defined here can be measured or averaged on a regular interval, have a slope and offset applied, be displayed on the front panel, be transmitted via Satlink or modem, and be used to identify alarm conditions.

Graphical Setup	Used to define both simple and complex measurements. Measurements can have one or more inputs cascading into one or more outputs. Special processing blocks can be used to implement complex calculations, including polynomial, interpolation table, f(x,y), and others. See the Processing section in Appendix A, for descriptions of all possible blocks.
I/O Modules	Used to view address and serial numbers of I/O modules connected to the system. The 9210 has three modules built into it, AIO1, DIO1 and DSP1. Note: If you connect any external I/O modules to a 9210, their module number MUST be set to 2 or higher. See Naming I/O Modules .
LAN Settings	Used to turn on the LAN (Ethernet) at boot (i.e., when Xpert powers on), or automatically when a device is connected. The sub-item, “LAN Setting – Transmit”, is used to configure scheduled and alarm transmissions over the LAN.
Log Files	Used to view, and define new, log files.
Satlink	Used to configure a Sutron Satlink transmitter.
Self Test	Used primarily by the factory for verifying the unit meets specifications. Please note that external test harnesses and cables are required for all tests to pass.
Setup File	Used to manage setups. On power up, the setup file having the same base name as the station name is loaded, or if such a file doesn't exist, the file “default.ssf” is loaded, if it exists.
SNTP	Used to configure system time synchronization to an NTP network time server.
Users	Used to define system users in terms of name, password, access level, and inactivity timeout.

Coms (SSP/CL)

Coms SSP/CL (functions included in coms.sll) enhances the remote communications abilities by adding support for the Sutron Speech/Voice modem, alarm detection and transmission with Speech, or via a Hayes compatible data modem, a LOS Radio modem, or a direct connection. Note: GPRS, Iridium, and Satlink communications are not managed in this entry. See their respective entries on the Setup tab.

SSP/CL com ports are configured for Remote in the autoexec.bat file; factory default is a direct connect on COM 1 with no alarms going out the port. To add support for alarms and/or speech to other COM ports, simply define them in the Coms (SSP/CL) entry in the *Setup* tab. The system will then reconfigure remote to start running the new configuration immediately and update the autoexec.bat for the next power cycle.

The **Coms Tag** block in the graphical setup is used to name SSP “cur data” points in the system and to specify speech phrases for Voice Modem, if defined. The **Alarm** block in the graphical setup is used to define what levels are considered “in-alarm”, which may trigger alerts (transmissions) over SSP/CL communication devices.

Alarm: A condition when one or more sensors exceed their alarm limits.

Alert: A condition which when triggered will cause the system to transmit immediate messages.

An Alert can be configured to occur when a sensor goes in to alarm, out of alarm, or both. When an Alert occurs the “Alarm Status:” on the Main menu turns to ALERT!. The system will then attempt to send an alarm message to the various configured devices. By default the software will try a Direct Connect first, then a LOS Radio, a Speech/Voice modem, and then finally a Data Modem. If at any time the ALERT is acknowledged, the system status will change to ALARM or NORMAL and the transmissions will stop. OFF will be displayed if alarm transmissions have been disabled by for instance a voice modem user or a Basic program.

The Direct Connect, LOS Radio, SSP and RS485 blocks are also capable of sending alarm messages on a regular interval. There can be one interval for when the system is in ALARM and another for when everything is NORMAL.

The [Clear] button (on MAIN TAB) is used to acknowledge an ALERT! condition manually, causing any alert transmissions to cease. If the system is still in ALARM that condition may be cleared as well by pressing the [Clear] button again, and the system should return to NORMAL until the next measurement occurs and any alarms are redetected. If ALERT transmissions have been disabled (OFF), then pressing the [Clear] button will re-enable them.

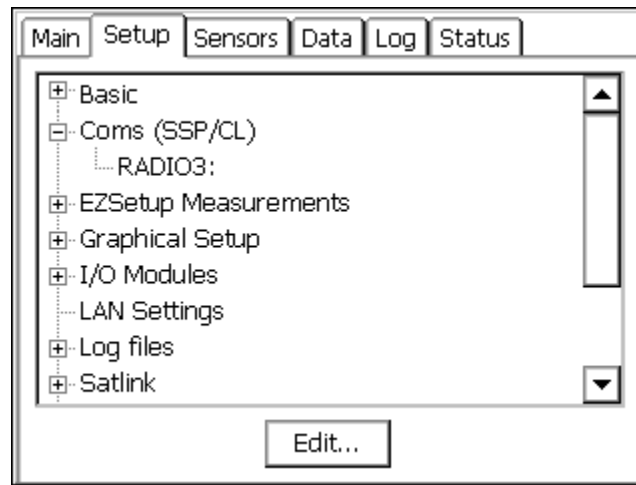

COMS (SSP/CL) Setup Menu

The Setup tab is used to assign the various devices to a port. This is done by clicking **Coms (SSP/CL)** and pressing [Edit...]. This brings up the Com Port Setup Menu as follows:

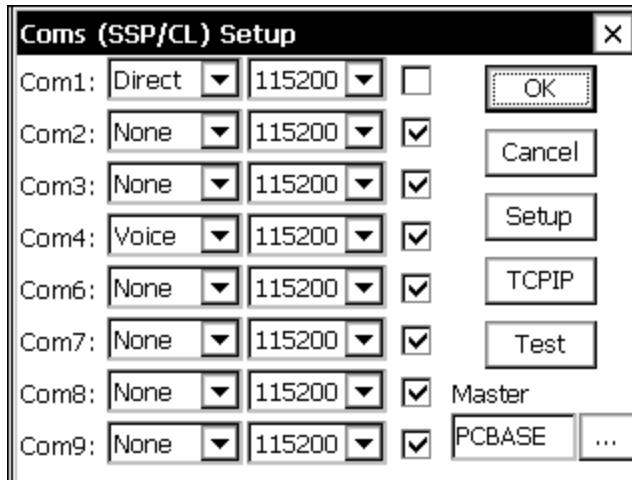

The ports and baud rate you wish to use are selected from this menu. Each port can be configured as None, Direct, Radio, Modem, Voice, SSP or RS-485 (if RS-485 option is installed).

Checking the checkbox next to each port will tell the Xlite to enhance and manage the port above and beyond what Remote alone does. This includes sending out alarms on the port, as well as handling speech dial-in, and dial-out, and support for SSP blocks which can be used to send and retrieve tags, or set the time. Typically, com1 would not be checked, as it is used for Xterm communications to setup the station. You would check it if you wanted to connect a communications device to com1 and see alarm data go out that port.

The Master ID, which is the name of the PC Base Station in an SSP system, is specified here too. Other SSP parameters can be specified in the Setup menu, and pressing the Test button will test communications.

SSP Settings

Pressing the Setup button displays this SSP setup menu. This menu will allow additional settings for SSP communications, over a variety of devices. All entries, except # retries, are in units of seconds.

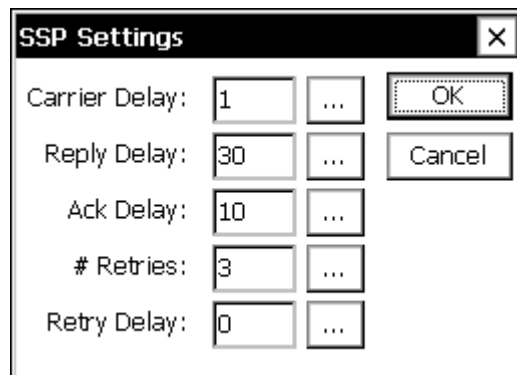

Carrier Delay: When the com port is set for "RADIO" communications, this is how long to key the transmitter (assert DTR) to warm up the radio before sending data. With Sutron radios

typically 1 second or less is needed, but this may need to be increased if hardware repeaters are used in the network, as each hard-repeater in the network needs time to warm-up.

Ack Delay: When the Xpert is acting as a master, this is how long to wait for a response to a request (aka an acknowledgement). The default value is 10 seconds, which is suitable for a single hop 1200 baud system. It may be reduced if higher-baud rates are available, or increased if store and forward repeater hops are necessary.

Retries: More precisely, this is the total number of tries. When an SSP request is made that requires a reply (such as a GetTag) the system will wait for the Ack Delay for the reply. If a reply is not received then one or more retries is performed. # Retries is the total number of attempts to make. The default value is 3. Combined with the default Ack Delay of 10 seconds, this means SSP will send the same message as many as 3 times, with a 10 second delay between each attempt before it will timeout and report a "tx error". All retry messages have the same FLAG SEQUENCE number as the original message. This is used to prevent the same message from being processed twice due to a long network delay.

Reply Delay: When the Xpert is acting as a slave, this is how long the RTU will wait for a message before timing out. This delay includes the time needed for all retries to occur, so it's typically set to the value of AckDelay * (# Retries). The only situation where the Xpert acts as a slave currently is when it's receiving a new setup from a base station. The Basic GetMessage() function may be used to add slave operations to the Xpert, but the timeout value is specified as a parameter to the function.

Retry Delay: This parameter is rarely used in the software and inserts an extra delay before attempting a retry, and is hence redundant with the AckDelay. Recommendation is to just leave it set to 0.

TCPIP Alarm Setup Menu

Pressing the TCPIP button displays the TCPIP Alarm Setup menu (requires V3.2 of the Xpert application or later). This menu allows alert and/or alarm messages to be configured to be sent to a base station over the LAN connection. The messages may be in SSP format or text format. Each URL is attempted in order (1 then 2, then 3) until the message has been successfully delivered (unless Send to All is enabled). As long as alerts are not disabled, when an alert occurs TCPIP delivery will be attempted first before other communication methods.

URL	Type	options
1: XCONNECT2	SSP	options
2: 127.0.0.1	Compute	options
3: myorg.gov	Data	options

Tx Normal Rate: 01:00:00 Send to All

Tx Alarm Rate: 00:10:00 Disable Alerts

(00:00:00 will disable a Tx)

OK Cancel

URL: Machine name or IP address to send a message to. Leaving an entry blank will cause it to be skipped.

Type: Type of message to send. SSP selects an SSP message. The Xpert2 waits for an OpAck packet to be received to confirm reception. Computer selects a text message with a prompt to press ENTER to confirm reception. Data also selects a text message but it doesn't wait for confirmation and assumes it has been delivered correctly if the TCPIP stack does not report an error making the connection and sending the message.

Tx Normal Rate: Selects an interval at which a message will be sent when the system is in the NORMAL state (entering 00:00:00 will disable this feature).

Tx Alarm Rate: Selects an interval at which a message will be sent when the system is in the ALARM state (entering 00:00:00 will disable this feature).

Send to All: If checked messages will be sent to all 3 URLs. If left unchecked then each URL is tried in order until a message has been delivered.

Disable Alerts: If checked this will disable alert messages to be sent via TCPIP, but not Tx Normal or Tx Alarm messages. Alert messages occur when a sensor transitions in to (or out of) the alarm state.

Options: The options button brings up further options that may be enabled for each URL.

The image shows a dialog box titled "TCPIP Options #1". It contains three input fields: "User Name" with the text "MYBASEID", "Password" with "*****", and "Port" with "23". Each field has a small "..." button to its right. Below the "User Name" and "Password" fields is the text "(leave blank if login is not required)". Below the "Port" field is the text "(default tcp port for telnet servers is 23)". At the bottom of the dialog are two buttons: "OK" and "Cancel".

User Name: SSP alarms may require a user name in order to login to the server before the alarm message can be sent. The user name can be specified with this field, leave it blank if login is not required.

Password: SSP alarms may require a password in order to login to the server before the alarm message can be sent. The password can be specified with this field, leave it blank if a password is not required.

Port: The messages are sent using TCP socket communications with auto-detection of the Telnet protocol. The standard port for a telnet server (including the Xpert2's) is 23, but on a base station that port may not be available (or desirable) and hence a different port number may be selected with this field.

Communication Test Menu

Pressing Test displays the following Test Menu. This menu gives communications statistics for the selected COM port along with a way to run some simple tests on the port. Key and UnKey force DTR on and off for the port. Send Mail and Check Mail can be used to communicate with other Xperts or a master station. Mail messages are simple text messages. Pressing Send Mail will cause the system to prompt you for a destination and a message. The destination can be a master station or another field station. For mail to work, you will need to have a dedicated or LOS radio communications link. Send and Check mail use Sutron Standard Protocol (SSP) for the mail messages.

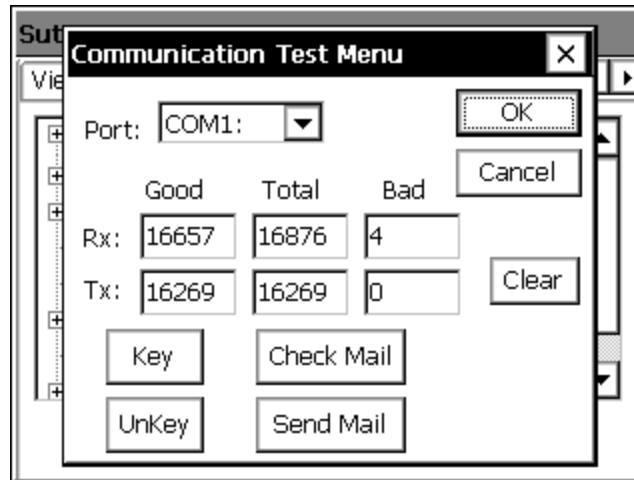

Coms Configuration Settings

After you define a device under Coms, it is displayed as a sub-item of the Coms entry. See the picture below, where the comms devices "RADIO2:" and "MODEM3:" have been defined.

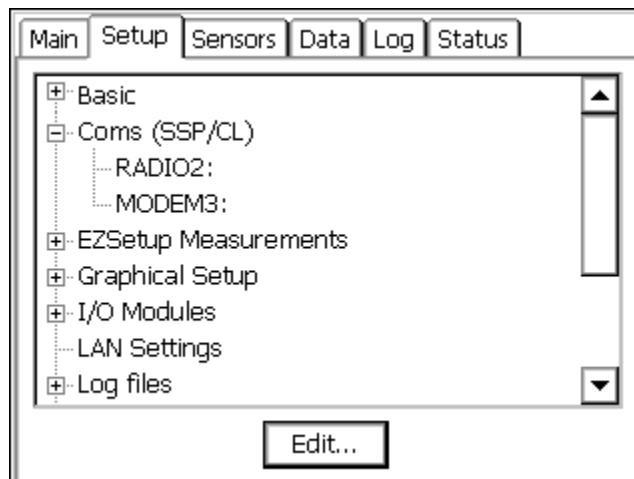

To access the configuration settings for one of these devices, simply highlight the device in the tree, and press the "Edit" button. This will bring up the config settings that are specific to the device selected, which are described in the following sections.

Direct Connect Settings

This dialog is used to configure the alarm and alert settings for the direct connection.

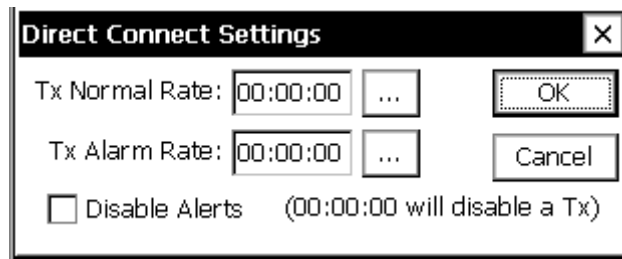

Tx Normal Rate is the rate at which alarms are transmitted when no sensors are in alarm, and *Tx Alarm Rate* is the rate used when a sensor is in alarm. They can be set to 00:00:00 to inhibit timed alarm transmissions. *Disable Alerts* may be checked to prevent messages to be sent out the port when the system enters the alert state.

Direct connections support two types of alarm messages. If SSP is detected, an SSP alarm is sent, otherwise a simple text message is sent, and a prompt is made asking for the alarm to be acknowledged.

Voice Modem Settings

This is the Voice Modem settings screen.

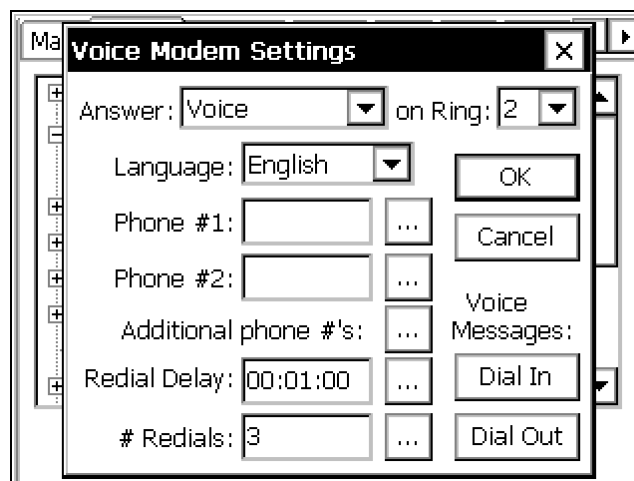

When an alert occurs each phone number is tried in sequence starting with Phone #1, until an acknowledgement occurs. Or until the # Redials has been attempted on each number. The Answer mode can be configured to answer in Voice, Data, or Voice & Data. The Voice & Data mode prompts when it answers the phone to "Please press pound". If the person dialing in presses the "#" key on the telephone a voice message is spoken, otherwise a data carrier is transmitted and a data connection is attempted. The Dial-in and Dial-out buttons allow the Dial-in and Dial-out messages to be configured. Speech phrases are stored in the \Flash Disk\speech\English directory or \Flash Disk\speech\[*language*] directory depending on which language is selected.

By default the voice modem will speak the specified Dial Out message. If the modem is unable to detect “ring-back” it may start speaking a phrase before someone answers the phone. Because of this, the message spoken should either be repeated or wait for a button to be pushed before speaking the alarm data. If a Dial Out message is not defined or the letter “D” is placed at the beginning of a phone-number then a data alarm will be sent. The data message will try to automatically detect a PC Base Station and send an SSP message, otherwise a simple text message is sent and a prompt is made asking for the alarm to be acknowledged.

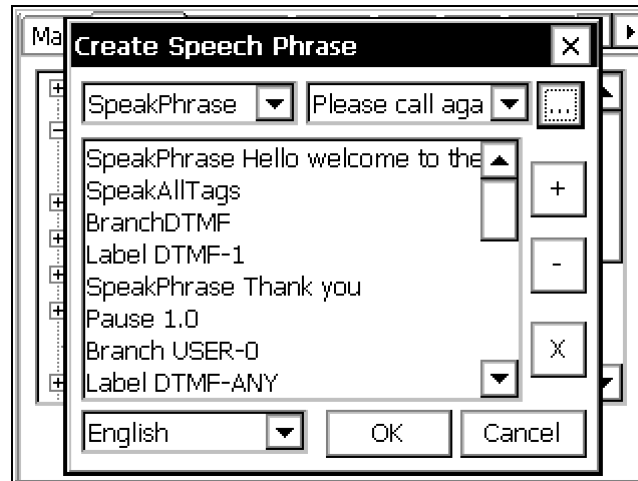

Above is an example of the speech phrase editor screen. The combo box in the top left is used to select a speech command (such as “SpeakPhrase”). The combo box in the top middle is used to select any optional parameters (such as the phrase to speak in this example). The [...] button is used to edit and/or add the command to the command list. [+] is used to move a phrase up in the list, and [-] is used to move a phrase down. [X] can be used to delete a phrase from the list. The combo box on the bottom of the screen can be used to select the language for the phrases displayed, this is used in conjunction with the “Language” command to setup a bilingual speech phrase.

Speech Dial-in and Dial-Out commands

Command	Description
AckAlarms	Acknowledges alarms in the system. Further alert transmissions will cease until a new alert occurs or it’s time for an alarm transmission.
AnswerData	Switches to answering the phone in data mode.
Branch	Branches to another part of the speech command specified by a user Label. Searching for the label begins with the first line in the speech command.
BranchDTMF	Waits for and branches based on a DTMF press. Searching for the label begins at the current line in the speech command. The phone will be hungup after 60 seconds if a button is not pushed.
BranchNoDTMF	Same as Branch, but the Branch is only performed if a DTMF button was not pressed on the phone. This is usefull for repeating a series of

	phrases over and over until the user pushes a button. If a button is pushed, it will be queued, and should be processed by a BranchDTMF command. Normally there is a 90 second inactivity timeout that is reduced to 60 seconds when this command is used. The phone is hungup if an inactivity timeout occurs.
Call	Calls a subroutine in another part of the speech command specified by a user Label. This works just like the Branch command, except that control may be returned to the command after the Call when a Return is encountered. Subroutines may call other subroutines.
DisableAlarms	Disables further alarm transmissions using the Voice modem and other SSP devices such as LOS Radio. They may be re-enabled using the EnableAlarms command, by Basic program, or by accessing the main menu and pressing CLEAR on the "Alarm: OFF" item.
EnableAlarms	Re-enables alarm transmissions that have been disabled with DisableAlarms.
Hangup	Hangsup the phone and terminates the speech command
InputManual	Inputs a number from the user. The number is entered with the DTMF keypad. "*" may be used to specify a decimal point. Press the "#" button is used to indicate the end. Pressing "*" twice will allow the number to be re-entered. See SpeakManual, and StoreManual. Example: 12*345# would enter the number 12.345. Negative numbers are not supported.
Label	Labels a section of the speech command, two types of labels exist. User and DTMF. DTMF labels are branched to in response to the BranchDTMF command, and user labels are branched to using the Branch command.
Language	Switches to the specified language folder. This effects all speech phrases that may be spoken (ex: SpeakPhrase and SpeakData) after the command. When adding phrases, be sure to select the appropriate language using the combo box at the bottom of the screen. Using subroutines (see Call and Return commands) it's possible to create a single phrase that can be spoken in multiple languages. The key is to select the language with the Language command and then Call the bi/multi-lingual phrase. For this to work, the (.vox) speech files must be given the same name across the languages.
Pause	Delays the speech command for the specified number of seconds (resolution down to milliseconds)
Return	Returns from a subroutine by branching back after the last Call command. If the Call command wasn't used, then control passes to the beginning of the phrase.

SpeakAlarms	Causes all sensors with an attached ComTag to have their prefix phrase, value, suffix phrase and alarm status spoken.
SpeakAllTags	Causes all sensors with an attached ComTag to have their prefix phrase, value, suffix phrase and alarm status spoken.
SpeakData	Speaks just the last measured data value of the specified sensor.
SpeakLiveData	Forces measurement and speaks just the live data value of the specified sensor.
SpeakLiveTag	Forces measurement and speaks the prefix phrase, live value, suffix phrase and alarm status of the specified sensor.
SpeakManual	Speaks the last data entered by the user with the InputManual command (or 0 if no value has been entered).
SpeakNum	Speaks the specified number.
SpeakPhrase	Speaks the specified phrase.
SpeakTag	Speaks the prefix phrase, value, suffix phrase and alarm status of the specified sensor.
StoreManual	Stores the last data entered by the user with the InputManual command (or 0 if no value has been entered) in to the specified tag. This allows the user to change operating values of the system (use WaitForPass to authorize).
WaitForPass	Pauses until the user enters a DTMF sequence which matches the specified sequence. The system will timeout if the user doesn't enter a code in less than one minute.

Use *Branch USER / BranchDTMF / Label*, to build a menu system.

Label USER-0
 SpeakPhrase Hello welcome to the Sutron Xpert
 Pause 1.0
 SpeakPhrase Please press pound
 Pause 2.0
 BranchNoDTMF USER-0

This introduction is repeated over and over (for up to 60 sec) until the user presses the “#” button on the phone.

BranchDTMF
 Label DMTF-#
 Label USER-1

SpeakPhrase For live data
 SpeakPhrase Please press
 SpeakPhrase 1
 Pause 1.0
 SpeakPhrase To acknowledge alarms
 SpeakPhrase Please press
 SpeakPhrase 2
 Pause 1.0
 SpeakPhrase To hang up
 SpeakPhrase Please press
 SpeakPhrase 3

BRANCH
 DTMF will go to
 the DTMF
 number pressed.

BranchDTMF
 Label DTMF-1
 SpeakAllTags
 Pause 1.0
 Branch USER-1

Label DTMF-2
 AckAlarms
 SpeakPhrase Alarm
 SpeakPhrase Acknowledge
 SpeakPhrase Thank you
 Pause 1.0
 Branch USER-1

Label DTMF-3
 SpeakPhrase Thank you
 SpeakPhrase Please call again
 Hangup

Label DTMF-ANY
 Branch USER-1

DTMF 1 speaks tags and DTMF 2 Acknowledges alarms, speaks alarms and then returns to the top menu (with BRANCH USER-0), DTMF 3 will hang-up the phone. Label DTMF-ANY say that if any other DTMF is pressed, return to the top menu.

LOS Radio/ SSP / RS-485 Settings

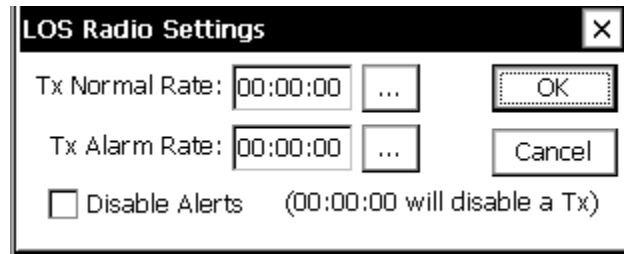

This is the LOS Radio settings screen. There are only three settings here. The Tx Normal Rate is the rate at which alarms are transmitted when no sensors are in alarm, and the Tx Alarm Rate which is the rate used when a sensor is in alarm. They can be set to 00:00:00 to inhibit timed alarm transmissions. Disable Alerts may be checked to prevent messages to be sent out the port when the system enters the alert state.

The LOS Radio only supports sending alarms to PC Base Stations using SSP (Sutron Standard Protocol).

The SSP and RS-485 options are very similar to the LOS Radio option. The primary difference being that SSP assumes a direct (SSP Only) serial connection between two devices, and RS-485 assumes there is an RS-485 connection. The difference is in how the control lines are used, but the options are the same.

Data Modem Settings

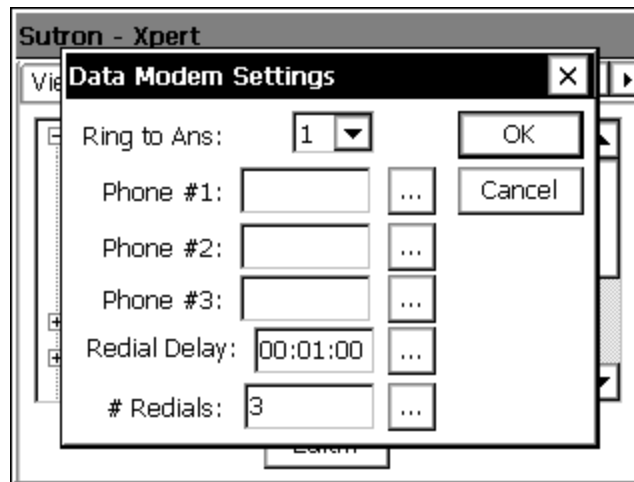

This is the Data Modem settings screen. When an alert occurs each phone number is tried in sequence starting with Phone #1, until an acknowledgement occurs. Or until the # Redials has been attempted on each number. The redial delay causes a pause between each redial attempt.

The Data Modem connection support two types of alarm messages. If a PC Base station is detected, an SSP alarm is sent, otherwise a simple text message is sent and a prompt is made asking for the alarm to be acknowledged.

EzSetup Measurements

EzSetup is used to define simple sensors based on a measurement interval. Sensors configured here may be measured or averaged on a regular interval, have a simple slope and offset applied, displayed on the front panel, transmitted via Satlink or modem and be used to identify alarm conditions. It is possible to configure an entire station using only this section for sensors, if no special processing is needed.

Measurements that are set up in EzSetup work in parallel with measurements set up in the Graphical Setup. Hence, one popular practice is to set up simple sensor configurations in EzSetup, and more complicated sensor configurations in Graphical Setup.

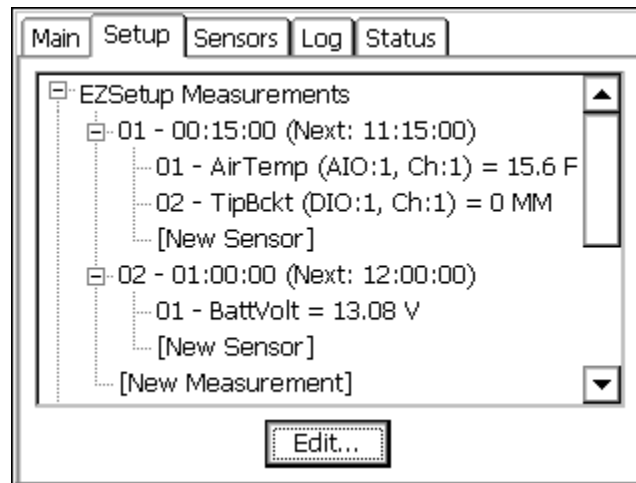

EzSetup organizes sensors by measurement schedule, similar to the way the 8210 data logger worked (though the Xpert can have multiple measurement schedules). Each measurement schedule has a set of sensors assigned to it. Whenever the measurement schedule executes, the sensors are measured.

In the example above, two measurement schedules have been defined. The first schedule will measure “AirTemp” and “TipBckt” every 15 minutes. The second will measure “BattVolt” every hour. You can see the next measurement of AirTemp and TipBckt will occur at 11:15:00, and that the last measured values for each of these parameters were 15.6F and 0MM. Note: this status information does not update automatically. To update, select the root entry “EZSetup Measurements”, and press the “Refresh” button.

Editing a measurement or sensor requires recording to be turned off. When you try to create or edit a measurement or sensor, the system will prompt you to stop recording. When the create or edit is complete, the system will prompt you to restart recording.

The measurements and sensors you define in EzSetup are stored in the Xpert setup file. If a setup file has been defined, it is saved automatically after making changes to EzSetup and leaving the Setup tab. You may also explicitly save the setup by selecting the “Setup” entry, and pressing the “Save As” button.

Measurement Schedules

To create a new measurement schedule, select the “[New Measurement]” entry and press the “Edit” button. To edit an existing measurement, select the entry in the tree and click “Edit”. To delete a measurement schedule, select the entry and click “Delete”. When creating or editing a measurement schedule, the following dialog is shown:

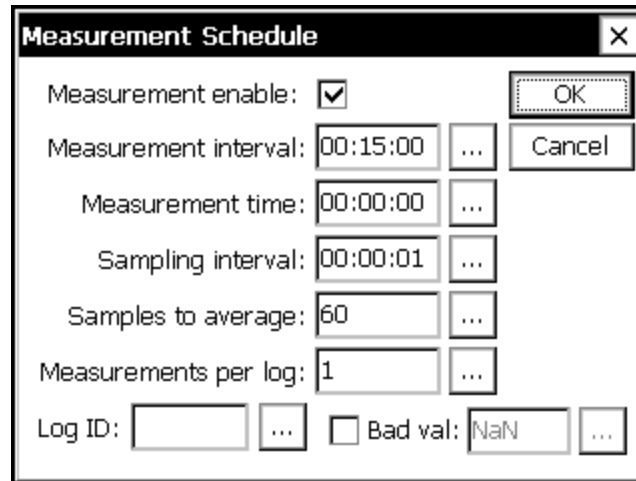

Differences from an 8210: Editing an EzSetup measurement is very much like the measurement schedules on the 8210 with a few differences. The 8210 has two fields named Power Time and Sampling Time which are not supported, and the order of processing has also been changed a little. Specifically, on the Xpert, all the non-averaged sensors are measured first, so these measurements occur as close as possible to the measurement time. Then averaging starts immediately following, and continues until either the “Samples to Average” is exceeded or the average time has expired. The average time expires when the next scheduled Measurement Interval is to start or the sampling window defined by the Sampling Interval and Samples to Average is exceeded.

MEASUREMENT ENABLE: This button is a quick way to disable a measurement if there’s a temporary issue that doesn’t warrant completely deleting it.

MEASUREMENT INTERVAL: Specifies how often the measurement is performed.

MEASUREMENT TIME: Specifies when the measurement is performed. This is can be viewed as an offset into the measurement interval and will typically be 00:00:00 as shown above. Setting it to 00:05:00 would cause the measurments to occur at 5 minutes, 20 minutes, 35 minutes, and 50 minutes past the hour. In other words, at 00:05:00 and every 15 minutes thereafter.

SAMPLING INTERVAL: For sensors with averaging enabled, the sampling interval specifies the timing between samples. Note: This should be at least as long as the time required to take the samples. If not, the “Samples to Average” takes on a new meaning described below.

SAMPLES TO AVERAGE: Specifies how many samples to take in averaging a sensor. Note: The sampling interval along with the samples to average defines a sampling window over which the samples will be taken. Sixty samples taken at a one second interval defines a sixty second sampling window. In situations where the sampling interval is shorter than the time required to

take the samples, the unit will take consecutive samples for the duration defined by the sampling window. In other words, if an SDI-12 sensor that took 2 seconds was being measured by the above setup, the averaging would be for 60 seconds (00:00:01 times 60) instead of 120 seconds needed for 60 samples. The unit must collect over half of the samples before the average will be marked with a “G” as good.

MEASUREMENTS PER LOG: Allows extra measurements to be taken which are not all logged. For instance, a value of 4 with a 00:15:00 interval would cause the 9210 to measure every 15 minutes, but log the specified sensor only every hour.

LOG ID: When this field contains a string, all sensors associated with this measurement are logged as a group, with the Log ID used as the data set’s name. When the Log ID field is empty, all items are logged separately, each with it’s own time stamp, units, and quality data. **NOTE:** The maximum size of a log entry is 2048 bytes. Hence, be careful to not create a Log ID that results in an entry larger than that. Also note that only 256 bytes of data can be shown for each log entry on the Log tab. Of course, all 2048 bytes are included in an export of the log.

After creating or editing a measurement schedule, it’s tree entry is shown collapsed. Expand the entry by clicking the “+” plus sign. This will show all the sensors assigned to the schedule. The order in which the sensors appear is important, as it determines the order in which the sensors are measured and logged.

BAD VAL: When checked, the value specified is logged for data whose quality is bad or undefined, as would be the case for example when an I/O error occurs during measurement processing. Any value can be entered, but note, when “NaN” is used, SSP time-tag data transmissions will include a “nil” for the parameter, per the protocol specification.

Sensor Configuration

A new sensor is added to a measurement schedule by selecting “[New Sensor]” and pressing “Edit”. To edit an existing sensor, select the entry and press “Edit”. To delete a sensor, select it and press “Delete”. When creating or editing a sensor, the following dialog is shown:

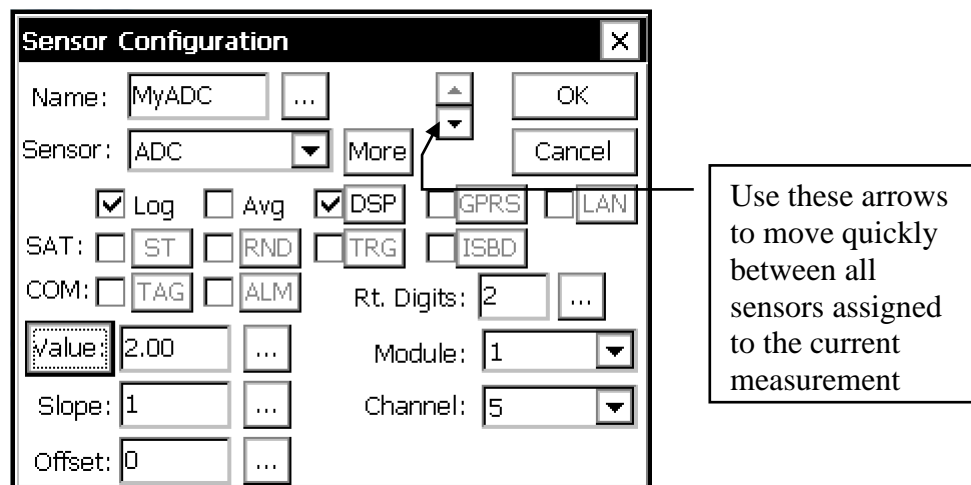

NAME: The name used when logging (except when Log ID is active), and when displaying the sensor value (in the EzSetup menu and the Sensors Tab).

SENSOR: Defines the sensor type to measure. Click the box to see the list of all possible sensor types. Note that each of these sensor types correspond to a sensor block that can also be used in the graphical setup. This means that all the descriptions for sensor blocks in Appendix A apply to the sensor type you select here.

MORE: This button brings up the configuration dialog for the selected sensor. See Appendix A for details on how to change the configuration. Note: Most sensors have many more important settings than can be shown on the EzSetup Sensor Configuration dialog. The additional settings are accessed by pressing “More”.

LOG: When checked, the system logs the output to ssp.log. Logging to ssp.log, as opposed to a log specified by the user, ensures the data is available through legacy telemetry channels. When ssp.log does not exist, the user is prompted to create it when leaving Setup.

AVG: When checked, the system averages the sensor according to the sampling schedule defined in the measurement schedule. **NOTE:** When using EzSetup to average both speed and direction of either the RMYoung and GillWind sensors, the system computes a **unit vector** average of wind direction, and a **scalar** average of wind speed. However, this is only the case when the sensors have been set-up properly, where the system considers speed and direction as coming from the same sensor (i.e., the sensor outputs are “linked”). You can verify proper setup by ensuring the speed and direction parameters are grouped together under the sensor entry. The following shows a proper setup for RMYoung.

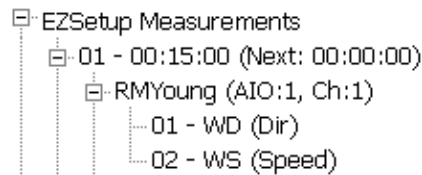

See the section “Multi-Output Sensors” for more information on how to ensure sensors with multiple outputs are set up properly.

DSP: When checked, the sensor will be included when displaying current values from the 9210 front panel. Pressing the DSP button will bring up a dialog that allows you to change the name and precision of the value shown on the front panel.

SAT-ST: Checkbox enables Self Timed transmissions for this sensor. Clicking the ST box will bring up additional properties, see Self-Timed Parameter block in Appendix A for details on settings.

SAT-RND: Checkbox enables Random transmissions for this sensor. Clicking the RND box will bring up additional properties, see Random Parameter block in Appendix A for details on settings.

SAT-TRG: Checkbox enables this sensor to trigger random transmissions. Clicking the TRG box will bring up additional properties, see Random Group block in Appendix A for details on settings.

GPRS, ISBD, LAN: Checkbox enables transmissions of this sensor over GPRS, Iridium, or LAN interfaces. Clicking the box next the check will bring up additional properties. GPRS.SLL or Iridium.SLL must be installed in order to use the GPRS or ISBD options, respectively.

COM-TAG: Checkbox enables this sensor for Coms (SSP/CL). Clicking the TAG box will bring up additional properties, see Coms Tag block in Appendix A for details on settings.

COM-ALM: Checkbox enables this sensor for alarms via Coms (SSP/CL, e.g., modem, LOS, etc.). Clicking the ALM box will bring up additional properties, see Coms Tag block in Appendix A for details on settings.

VALUE: The Value box shows the last measured value for the sensor. Press the value button to take a reading immediately and display it. Editing the value (by pressing ...) will modify the Offset such that future readings will equal the entered value. Simply set the offset back to 0 to undo this.

RT. DIGITS: Sets the number of right digits used when displaying and logging the sensor.

SLOPE/OFFSET: The current slope and offset assigned to the sensor.

MODULE/CHANNEL/PORT/ADDR: These settings mirror those found in the sensor configuration dialog. The setting will appear only when the selected sensor type supports the property. For example, when the sensor type is ADC, the Module and Channel properties are shown in the Sensor Configuration dialog, as well as on the dialog that appears once “More” is clicked. Note: Most sensors have many more important settings than can be shown on the EzSetup Sensor Configuration dialog. The additional settings are accessed by pressing “More”.

PARAMETER: Appears when a sensor has more than one possible output. For instance an AT/RH sensor has both an air temperature, and a relative humidity output. Select the one to measure.

Multi-Output Sensors

Several sensors have more than one output parameter to select for measurement. For example, the SDI-12 sensor offers output parameters 1 through 20, the RMYoung and GillWind sensors offer output parameters “Speed” and “Dir”, and the Counter sensor provides “Count”, “DeltaCount”, and “Freq” output parameters. When a sensor with multiple outputs is selected in the Sensor Configuration dialog, the dialog allows the user to select the output parameter to use (see “Parameter” in the dialog, below).

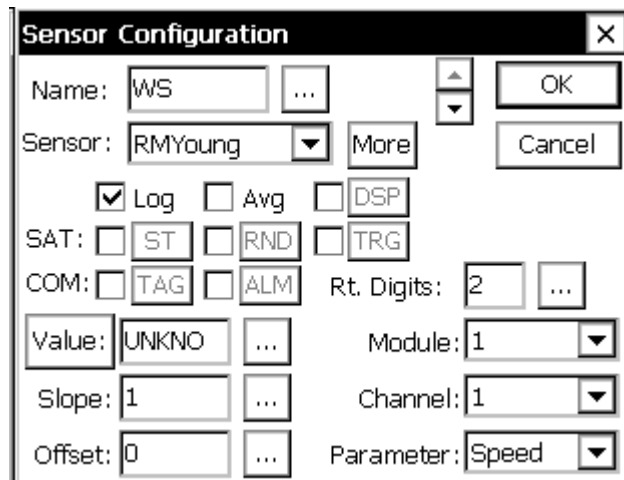

When you want to measure more than one output of a multi-output sensor, you must set up a separate sensor entry for each output to be measured. When each output is set up properly, the system makes only one measurement of the sensor, as opposed to a separate measurement for each output. This is especially important for sensors that take a significant time to measure (imagine taking 5 separate measurements to obtain 5 parameters from an SDI sensor that takes 30 seconds to measure!). In addition, for some sensors, it may be important to ensure parameters were measured at the same time.

To ensure only one measurement is made for all outputs of a single sensor, **the I/O device configuration for each sensor entry representing a separate output, must be the same.** The I/O device configuration consists of different parameters for different types of sensors. If the sensor reads an analog input, then the analog input's module and channel must be the same. If the sensor reads a com port to obtain its input, then the com port must be the same. For SDI-12 sensor's, the SDI-12 address and command must be the same. Note: the I/O device configuration must be set the same **when creating the sensor entry.** Changing the configuration to be the same after the entry has been made, does not result in "linking" any outputs.

In the example below, the Dir and Speed outputs of the RMYoung sensor are linked. One measurement of the sensor will be made every 15 minutes to obtain both values, Dir and Speed. The same is the case for the GillWind sensor on COM4. However, the GillWind sensor on COM5 does not have its outputs linked. This would happen if, for example, the Speed sensor entry was created with the selection of COM7 and then changed to COM6 to match the Dir entry.

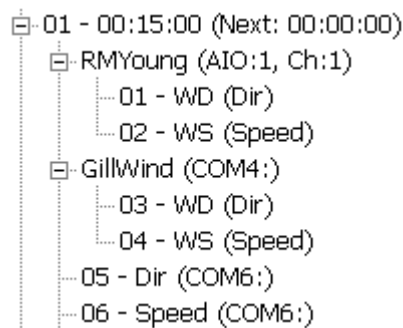

Once outputs are linked, **a change to one will affect all linked outputs.** Using the above as an example, if you select the GillWind Dir entry and change its com port to COM3, it will change for the Speed setting as well.

Once an output has been linked, you must delete the entry to "unlink" it. Hence, to fix the fact that the Speed output of the GillWind sensor on COM6 is not linked to the Dir output, you would first delete the Speed entry, and then re-add it, making sure to set the com port setting to COM6 in the process.

Event Driven Sensors

The vast majority of sensors measure when told to, i.e., according to the measurement schedule you define. The exception to this rule occurs when using a sensor with an *Event* option checked (like BinIn). Every time an *Event* occurs, the entire set of sensors defined under the measurement schedule will be measured. For example, if you had an EZSetup measurement schedule with the

BinIn block (*Event checked*) and an sdi-12 sensor, every time the BinIn detected a change of state, the SDI-12 sensor would also be measured.

Graphical Setup

The *Graphical Setup* branch of the Setup tab is used to manage the portion of the system's setup that has been defined by interconnecting graphical blocks, where each block represents a function such as sensor, measure, or log. This method of setup should be used to define sensors that can't be setup using the *EZSetup Measurements*. This would include sensors that need to have a polynomial, interpolation table or any other special processing done to them.

See the section in Appendix A that covers Processing blocks to see all the available processing. See Chapter 4: Setup Diagrams, for detailed descriptions of how to set up sensors in this way. This is also where setups defined with versions before 2.0.0.0 will be loaded.

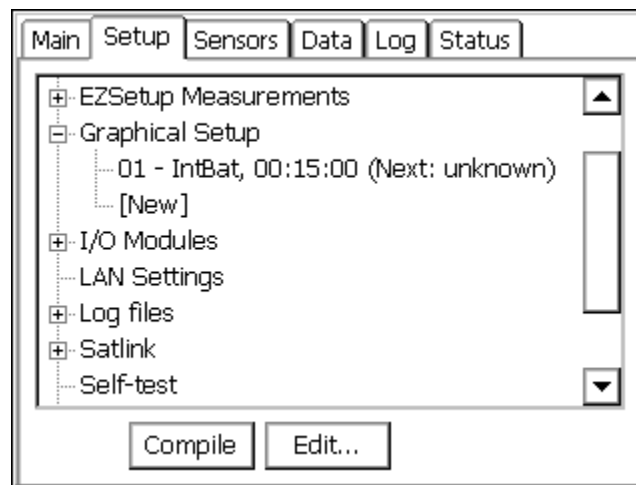

The details of whatever measurements have been graphically defined will be displayed underneath the *Graphical Setup* main branch. Some of the details shown for each measurement include: sensor name, channel usage, last data value and quality (quality only if it is bad), and scheduling information, including the time of the next measurement.

Selecting a measurement sub-branch and pressing *Edit* will cause the system to display the measurement graphically, i.e., in terms of the blocks that define it. Only the blocks of the measurement selected will be displayed.

Press the *View* button to view the block diagram in read-only mode.

To display the blocks of all measurements that have been defined graphically, select the *Graphical Setup* branch and press *Edit*.

To define a new measurement graphically, select [New] and press Edit. This causes the system to display the graphical setup page with no blocks yet defined.

To remove an entire graphical block chain, click it, click EDIT and then click the left most block and do a delete right

I/O Modules

The I/O modules branch displays the I/O modules currently connected to the system. These modules are used for hooking up all sensors to the system except SDI-12 sensors. Up to ten modules can be connected together and then plugged into the I2C port at the bottom of the logger. Specific details on individual modules can be found in Appendix C.

If you select an I/O module in the *Setup* tab and press *Edit...* the following dialog will appear. This dialog gives the serial number of the I/O module, its name and its I2C address. Only the I/O module number can be changed. This number is stored into the flash of the I/O module, so it remembers it on power cycles.

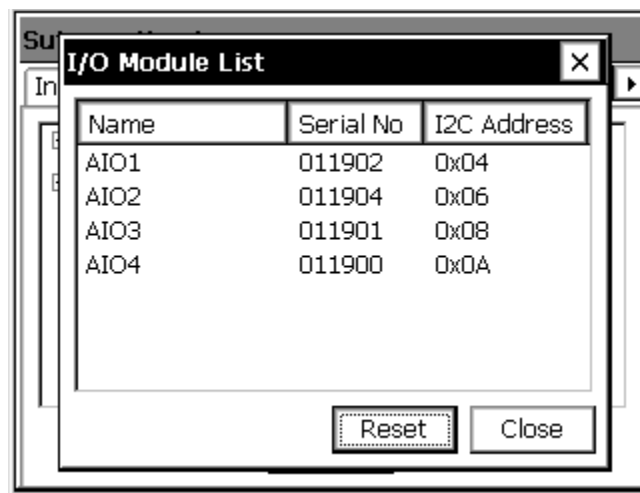
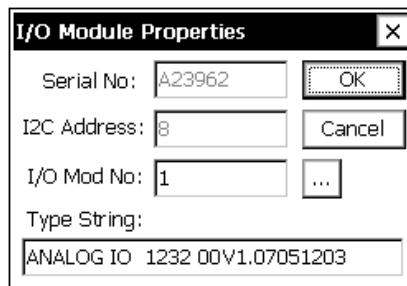

NOTE: All I/O Module Names must be unique (see above screen shot). If not unique, change the module number as described in the Naming I/O Modules section below.

Naming I/O Modules

An I/O module name consists of a three character descriptor indicating module type that cannot be changed plus a unique module number. The number of the module can be changed. The system utilizes the more descriptive modules names, AIO1 (Analog I/O Module #1), AIO2 (Analog I/O Module #2), to differentiate between modules when setting up measurements rather than having to specify serial numbers. The generic and user changeable naming of the modules also simplifies the process of changing one module for another. The system must not have more than one type of module with the same number, I.E. If a system has two analog modules both

modules cannot be module number one, but it is possible to have a digital module one and an analog module one.

Resetting I/O Modules

Pressing *Reset* will “reboot” the I2C bus, it is similar to disconnecting and reconnecting the modules. This is only needed if a module that is connected does not show up in this list.

LAN Settings

The *LAN Settings* branch of the *Setup* tab enables you to control power to the LAN (Ethernet). To display the LAN Settings dialog, select the *LAN Settings* entry and press the *Edit...* button. The following dialog displays:

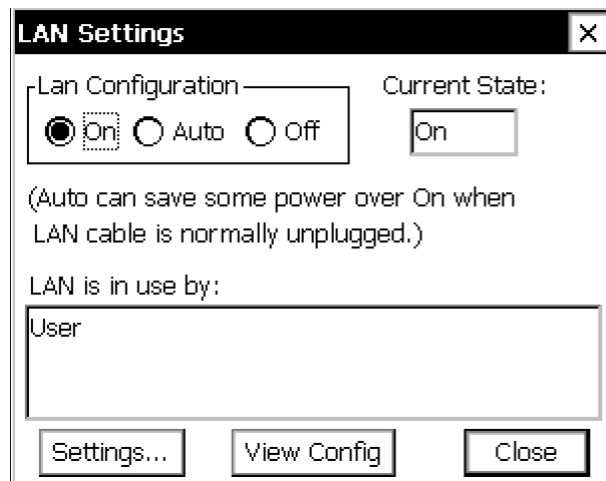

The *Lan Configuration* buttons (*On*, *Auto*, and *Off*) determine the state of the LAN when the Xpert first boots. *On* causes the LAN to be turned on at boot. The LAN stays on until explicitly turned off. *Auto* turns the LAN on only when something is connected to the ethernet jack. *Auto* is typically only set when you plan to connect your PC or laptop directly to the Xpert (which requires a special ethernet *crossover* cable; see below). When *Auto* is selected and a device is not connected to the ethernet port, the system draws only about 1mA more power than if the state was set to *Off*.

The *LAN is in use by* area displays the list of elements that have requested the LAN to be on. This area will show “User” when the LAN Configuration setting is On, “Modbus” when a modbus process has requested the LAN to be on, and so on.

Press the *View Config* button to view details (IP address, DNS server, etc.) about the current connection.

When you press the *Settings...* button, the system will ask whether you want to run the Network Wizard, which will ask several questions and then set LAN settings based on your answers. If you answer No to running the wizard, you instead are prompted with a dialog from which you can manually configure network properties.

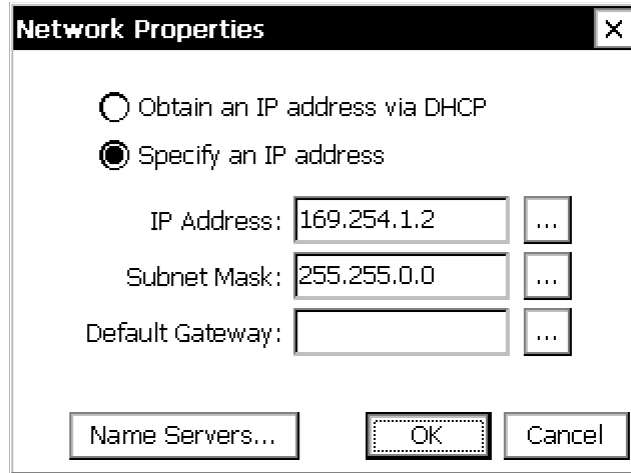

The Network Properties dialog is used to specify how the Xpert gets an IP address. Typically, when the Xpert is connected to a network that provides DHCP services, select “Obtain an IP address via DHCP”. If DHCP services are not available, or if you desire a static IP address for other reasons, select “Specify an IP address”, and enter the IP address and Subnet Mask. You can press the *Name Servers...* button to enter DNS and WINS address information, if desired.

Crossover Connections

An ethernet crossover cable is a special kind of ethernet cable that acts similar to a null modem cable where TX and RX are crossed in order to facilitate host to host communications. The crossover cable allows you to connect the Xpert directly to a PC or laptop, without the need for a router between the two. This cable can be purchased most anywhere standard ethernet cables can be purchased.

When using a crossover cable, set the LAN Configuration either to *On* or to *Auto*. As mentioned above, *Auto* will turn the LAN on and off automatically according to whether there is something connected to the ethernet jack.

Since there’s no router in a crossover connection, it’s best to assign a static IP. If you don’t, the Xpert will still assign a default IP that Xterm can find and use, but the connection process occurs more slowly.

LAN Settings - Transmit

The Transmit dialog is used to configure the system to perform transmissions over the LAN. When the “Enable” check box is checked, transmissions occur at the interval and offset time provided, in the selected format. Data values are defined by the LAN telemetry tag setup blocks in the graphical setup. Transmissions occur to the servers defined in the Servers dialog, described below.

If the format is interleaved (e.g., PseudoBin-B or ASCII Column), then Num Values may be set in this dialog, to indicate the number of sensor values to include in the transmission. If the format is non-interleaved (i.e., transmission contains all sensor 1 data, then all sensor 2 data, etc.), then specify Num Values in each of the LAN telemetry tag setup blocks.

When Alarm Data is “AllSensors”, an alarm transmission consists of all sensors selected by the LAN telemetry tag blocks (the same as a self-timed transmission). Otherwise, when Alarm Data is “SensorsInAlarm”, only the sensor data triggering the alarm is transmitted.

When “Retransmit” is checked, data from failed self-timed transmissions (due to a network outage, for example), are retransmitted on the next successful self-timed connection. Note that the most recent data is always transmitted first on the first successful reconnect, followed by the oldest to newest data from any previous failed transmissions. Up to 7 days of missed data will be retransmitted.

Note: A system reboot prevents retransmission of data logged by LogField blocks and EzSetup. For complete retransmission support, log data using the standard Log blocks in Graphical Setup.

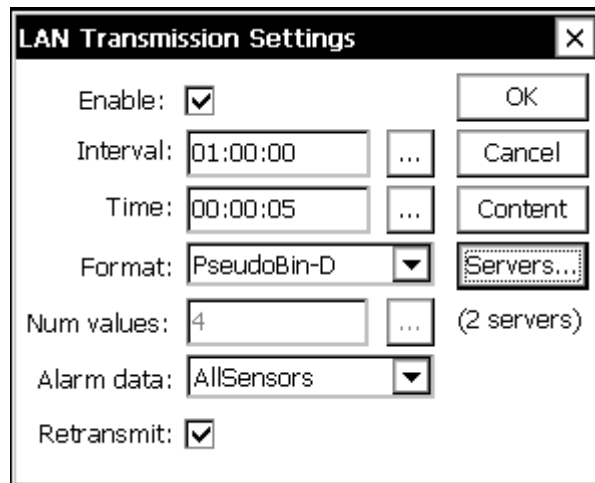

Pressing the “Servers...” button opens the “LAN Transmit Servers” dialog, which is used to define the servers to receive the transmission. Use the “New...” button to create a new server destination. Use the “Change...” button to edit the settings of an existing server destination.

When Tx Mode is “Fallback”, each server is tried in turn until a transmission succeeds. When Tx Mode is “All Servers”, the system transmits to all defined servers, at the same time.

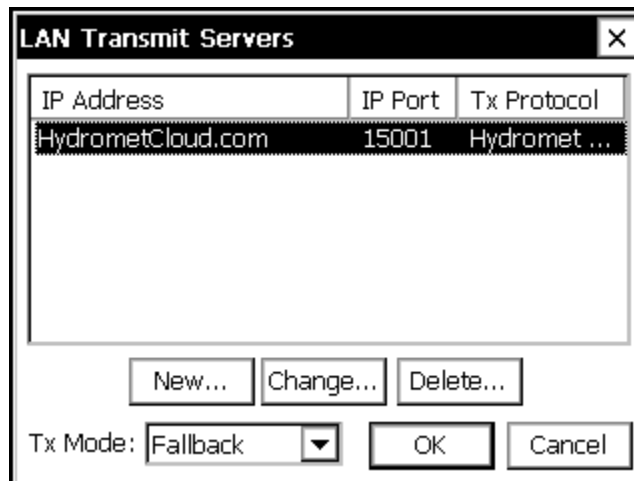

Pressing either the “New...” or “Change...” button opens the LAN Transmit Server dialog, which is used to edit the settings of a server entry.

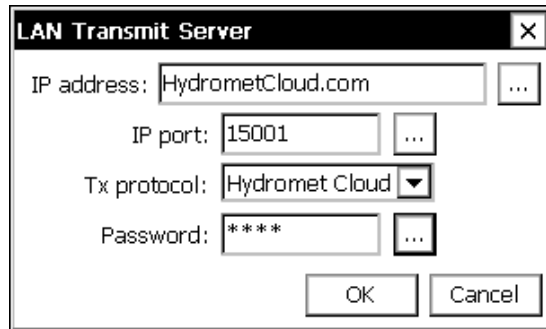

To define a server, enter the server’s internet address and port into the IP Address and IP port properties, respectively.

Tx Protocol may be set to either “Hydromet Cloud” or “None”. When “Hydromet Cloud” is selected, transmissions may be made to Sutron’s Hydromet Cloud service (formerly, “SutronWin”), or to AutoPoll using an AutoPoll task type of “Capture” with the “Hydromet Cloud compatible” option selected.

When Tx Protocol is set to “None”, the Hydromet Cloud compatible protocol is bypassed, and the data is simply dumped to the destination server. Transmissions may be made to AutoPoll in this case using an AutoPoll task type of “Capture” with the “Hydromet Cloud compatible” option deselected.

The Password property applies only to the Hydromet Cloud protocol, and must match the password entered in the server.

LAN Tx Tab

When LAN transmissions are enabled, a new tab is displayed, called “LAN Tx”. This tab shows the status of the transmitter, and offers an option to force a transmission for testing purposes.

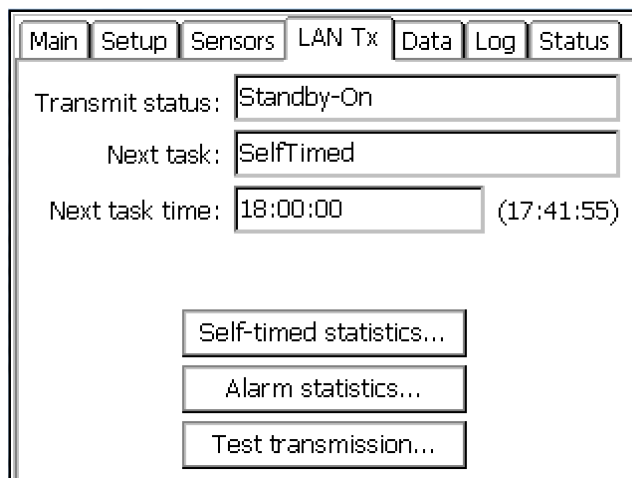

Log Files

The *Log Files* branch of the *Setup* tab allows management of all the log files that have been added to the system. Multiple log files can be stored in physical memory space, only limited by the amount of memory in the system. Multiple files can be open at one time; therefore, ten sensor signals can be logging to ten separate files (or to five files or one for that matter).

To display a more detailed listing of the log files in the system, click *Log files* and then press the *Edit...* button at the bottom of the screen:

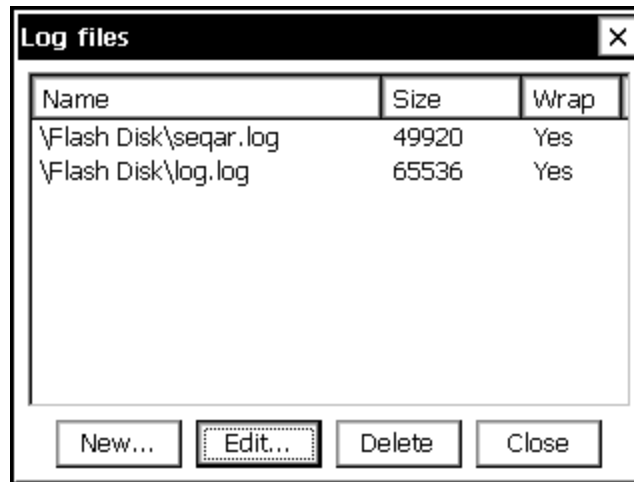

Log Properties

For each log file, this window lists the name of the file (\\location\\name.log), the size of the file, and whether or not the file should wrap. You can create a new dialog by pressing New, or edit the properties of a log file by highlighting the file and pressing "Edit...". In both cases, the following dialog is shown:

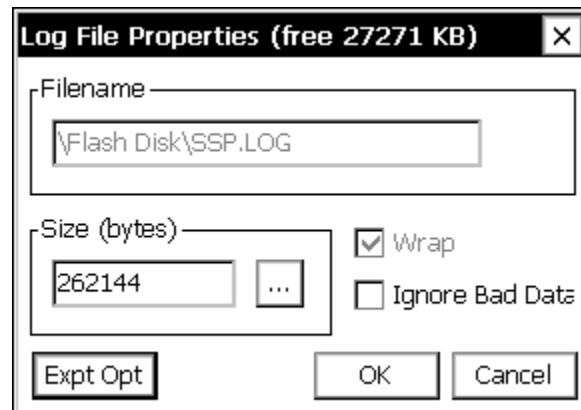

The file size is the maximum size of the log file in bytes.

Wrap specifies what should happen once the file has been filled up to its maximum size. If wrapping is set to 'Yes' and the file fills up, the system will delete some of the old data to make room for the new data. This way the log file will always be full of the most recent data.

If wrapping is set to 'No' and the file fills up, the system will not store the additional data in the log and the new data will be lost. Note that Wrap can only be set when creating a new log.

"Ignore Bad Data", when checked, means don't log any data unless it has good quality ("G").

Pressing the "Expt Opt" button will bring up the Export Log Options dialog. See below, for a description of this dialog.

Creating New Logs

When creating a new log, it might take a minute or two after pressing OK for the file to be initialized. During this time, nothing else can be done with the unit (an hourglass is displayed during log file creation).

On SD cards with Gigabyte capacities, creating larger log files will take MUCH longer. To create a 100 megabyte (104857600 bytes as entered) log file, the unit will take about 7 minutes, to create a 1 Gigabyte log file, expect the unit to be busy for over an hour.

Use \Flash disk*filename*.log to store log files into internal flash.

Use \USB Card*filename*.log to store file onto a USB "thumb drive".

Use \SD Card*filename*.log to store file onto an SD storage card.

Sizing Logs

Since each logged data point takes between ten and fifteen bytes of memory, a log file 60,000 bytes in size will hold between 4000 and 6000 data points, or between 1.5 and 2 months of a single sensor measurement, made every 15 minutes.

You can change the size of an existing log from the Log File Properties dialog. The size can be increased without losing any data currently in the log. If the size is decreased, you will lose some of the data in the log. **If you are decreasing the size of the log, you may want to retrieve the data from the log so it is not lost.**

Note: the minimum log size is 2048 bytes. The maximum log size is the lesser of 1) 2 billion bytes, or 2) the free space available on the storage medium minus a small safety buffer (32k for storage cards, 192k for Flash Disk).

Export Log Options

Pressing the "Expt Opt" button on the Log File Properties dialog brings up the following dialog, used to define options related to exporting a log file.

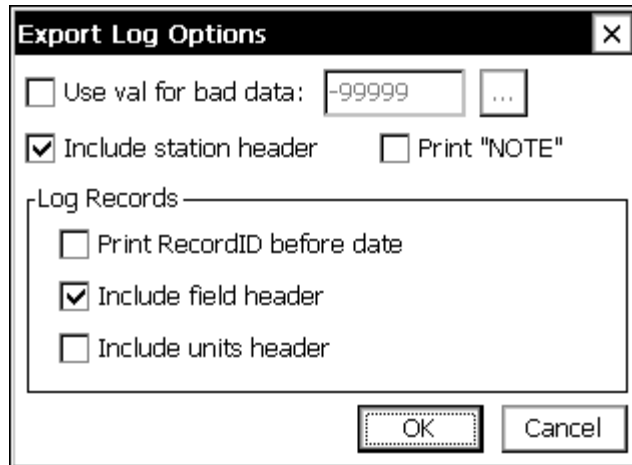

When “Use val for bad data” is checked, all data marked with Bad quality (“B”), is replaced with the supplied value on export.

When “Include station header” is checked, the export will contain a header containing the station name. This makes it easy to identify which station the export came from.

When “Print NOTE” is checked, log notes will be exported (and displayed in log tab) with NOTE in the sensor field and the note text in the data field. By default this option is not checked, meaning “NOTE” is not printed, and the note text is displayed in the sensor field.

When “Print RecordID before date” is checked, the RecordID field for all log records, if any, is printed before the date and time.

When “Include field header” is checked, the exported file contains a header describing the format of each log record field, if any.

When “Include units header” is checked, the exported file contains a header that lists the units assigned to each log record field, if any.

Example Header

Here’s an example of a header that includes the station name, as well as field and units headers:

```
Station Name
Xpert
Date, Time, RecID, AT, RH, HeatFlux, Esen, Dielectric, Moisture, NetRad, SoilTemp
mm/dd/yyyy, HH:MM:SS, C, %, W/m2, uV/W/m2, , %, W/m2, C
01/27/2012, 16:39:00, Default, 155.47, 100.00, 0.00, 0.00, 0.00, 0.00, 0.00, 0.00
01/27/2012, 16:39:30, Default, 154.82, 100.00, 1829.85, 42.69, 380.42, 229.92, -27847.42, -24.36
```

Satlink

The *Satlink* branch is used when you have a Sutron Satlink transmitter connected to the Xpert. This branch is used to manage the details of the setup for both self-timed and random transmissions.

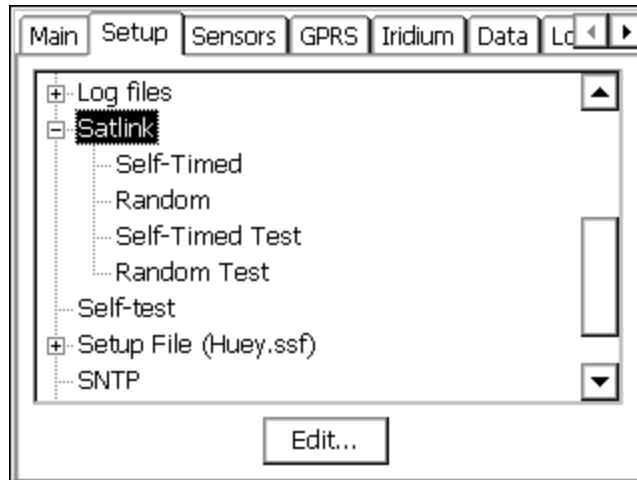

Satlink Dialog

Selecting Satlink and pressing Edit brings up the main Satlink dialog.

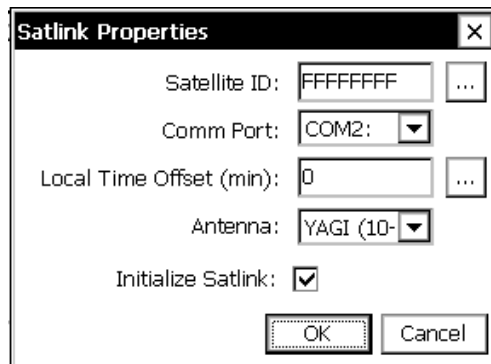

Satellite ID

This property is the *Satellite ID* for both self-timed and random transmissions. The *Satellite ID* is a hexadecimal number, 8 digits long, assigned by NESDIS, EUMETSAT or some other authorizing agency.

Comm Port

The *Com Port* property identifies the COM port to which Satlink is connected. Satlink connects to the comm. port using a standard DB9 serial cable.

Local Time Offset

The *Local Time Offset* property defines the difference between the current local time and UTC (Universal Time Coordinated). This offset is sent to Satlink at recording start. The offset is specified in number of minutes, and may be negative. The Xpert uses the local time offset and the UTC time received from Satlink to set the Xpert's clock. In addition, the offset is sent to Satlink (Satlink 2's use this value to determine local time).

Antenna

The *Antenna* property identifies the type of antenna you have connected to Satlink.

Initialize Satlink

The *Initialize Satlink* check box controls whether or not to send transmission settings to Satlink at the start of recording. When this box is checked, the transmission settings (times, rates, channels, etc.) are sent to the Satlink whenever the unit is started, otherwise, settings are not sent to the Satlink, but assume instead that Satlink has been configured by some other program (e.g., *Satlink Communicator*).

Self-Timed Dialog

The Self-Timed dialog allows the setting of the Self-Timed transmission properties. The properties correspond to settings that will be sent to Satlink to configure it as well as settings that will be used by the Xpert itself to make the transmission. A typical dialog is shown below followed by a brief explanation of each property.

Enable Self-Timed	<input type="checkbox"/>	Append Lat/Lon	<input type="checkbox"/>
Center in Window	<input checked="" type="checkbox"/>	Append Batt Voltage	<input type="checkbox"/>
Channel:	151	Time:	00:00:00
Num Vals:	1	Rate:	04:00:00
Format:	SHEF	Window:	00:01:00
Type:	300 bps	Antenna:	YAGI (10-1)

More... OK Cancel

Enable Self-Timed

This box must be checked for the system to make self-timed transmissions. This field is sent to the Satlink to configure it and uses the field to control its own scheduling.

Center in Window

This box instructs Satlink to center each timed transmission in the transmission window. Normally, a transmitter has a transmission window that is larger than the length of the transmission it must make. When “Center in Window” is selected, Satlink will delay each transmission so it is centered in the window. The Window size is entered in the Window Property on this dialog.

Append Lat/Lon

Satlink transmitters have a GPS (Global Positioning System) receiver which is capable of determining its latitude and longitude. This check box instructs Satlink to add the Latitude and Longitude to the end of each transmission.

Append Batt Voltage

This check box configures Satlink to append the loaded Battery voltage (taken at last TX) to the end of the transmission.

Channel

This property defines the channel that Satlink will use to make the self-timed transmission.

Num Vals

This property defines the number of values to include in the self-timed transmission. This value is used for the BIN-INT and ASCII Column transmission formats to set the number of values to send for each sensor (e.g., if set to 32 and 4 sensors are sending data, then a total of 128 data values are sent), other formats will use the NUM VALUES defined in the self-timed blocks entered into the setup. The number entered here will also set the default value when placing a self-timed block into the setup.

Format

Support for several standard formats is included. The supported formats are:

- “ASCII Column” is a human readable format with sensor values in columns. Each row represents data from a previous measurement interval
- “SHEF” format conforms to NESDIS Standard Decimal format specifications. The format is ASCII and readable by persons without the aid of a computer.
- “SHEF Fixed” is a special version of the SHEF format where numbers are fixed to seven decimal points. Receive sites that handle messages with variable length data can use this format.
- “Bin Int” is a binary interleaved format, identical to the 8210 binary transmission format. The data are in the 6-bit pseudo binary format required by NESDIS.
- “Bin NonInt” is a binary non-interleaved format. This format also uses the 6-bit pseudo binary format but allows different amounts of data to be sent for each sensor. The data is not interleaved, i.e., one sensor’s data set appears together in the transmission.
- “NOS” conforms to NOS requirements for its tidal stations.
- “NFDRS” conforms to NFDRS requirements for its fire weather stations.
- “INSAT” conforms to INSAT requirements for its stations.
- "HANDAR" is a format where sensors are separated by <CRLF>, sensor data is separated with a space and missing data is an "M". The oldest data is first (to left), as in:

```
010034380517419:21:30G42+0NN155E9200070"  
1.3 1.3 1.3 1.3  
2.4 2.4 2.4 2.4  
M 12.2 12.2 12.2 12.2 12.3 12.3 12.3
```

Type

The Type property defines the satellite type and baud rate for the transmission. You can select from GOES 100 (CGMA 100 INTL), GOES 300, GOES 1200, as well as MSG (for METOESAT), INSAT, and others.

Time

Time is the transmission time assigned to the station. Each station will have a unique transmission time, rate and channel assigned by NESDIS, EUMETSAT or other authorized agency. The transmission time is entered in UTC.

Rate

The Rate, along with the transmission time determines when transmissions are made. The units for the rate are HH:MM:SS. Typical rates are 01:00:00 for hourly transmissions and 04:00:00 for transmissions every 4 hours.

Window

This property defines the size of the window, in HH:MM:SS, that is given for the transmission. Satlink only uses this window size if the box “Center in Window” is checked.

Random Dialog

The Random Dialog allows the setting of the Random transmission properties. Random transmissions are those that are made at random intervals. The properties correspond to settings that will be sent to Satlink to configure it as well as settings that will be used by software to make the transmission. A typical dialog is shown below followed by a brief explanation of each property.

The screenshot shows a dialog box titled "Random Properties". It contains the following fields and controls:

- Enable Random
- Append Lat/Lon
- Append Batt Voltage
- Norm Rt: 12:00:00 [Browse]
- Channel: 151 [Browse]
- Alarm Rt: 01:00:00 [Browse]
- Type: GOES 300 [Dropdown]
- Burst Rt: 00:01:00 [Browse]
- # Burst: 3 [Browse]
- Format: Bin Int [Dropdown]
- # 1 [Browse]
- OK [Button]
- Cancel [Button]

Enable Random

This box must be checked for the system to make random transmissions. This field is sent to the Satlink to configure the transmitter and uses the field to control its own scheduling.

Append Lat/Lon

Satlink transmitters have a GPS (Global Positioning System) receiver which is capable of determining its latitude and longitude. This check box instructs Satlink to add the Latitude and Longitude to the end of each transmission.

Append Quality

This check box configures Satlink to append quality data to the end of the transmission. Note: as of version 4.11 of Satlink, Satlink has not yet implemented this function.

Norm Rt

The “Normal Rate” property defines how often random transmissions will be made, when the unit is not in alarm. The rate is specified in HH:MM:SS.

Alarm Rt

The “Alarm Rate” property defines how often random transmissions will be made when the unit is in alarm, following burst transmission(s). The rate is specified in HH:MM:SS.

Burst Rt

The “Burst Rate” property defines how often the “# Burst” random transmissions will be made. These burst transmissions occur when the unit first goes into alarm. The rate is specified in HH:MM:SS.

Format

Several formats are supported for random transmissions:

“Bin Int” is a binary interleaved format, identical to the 8210 binary transmission format. The data are in the 6-bit pseudo binary format required by NESDIS.

“Bin NonInt” is a binary non-interleaved format. This format also uses the 6-bit pseudo binary format but allows different amounts of data to be sent for each sensor. The data is not interleaved, i.e., one sensor’s data set appears together in the transmission.

Channel

This property defines the channel that Satlink will use to make the random transmission.

Type

This property defines the baud rate for the transmission. The valid selections are 100 and 300.

Burst

The “# Burst” property defines how many transmissions Satlink will make when the unit first goes into alarm. This value is normally set to one. When set to a value other than one, Satlink will make this number of transmissions with each transmission separated by Burst Rate number of seconds.

Values

This property defines the number of values to include in the random transmission. This value is used for the BIN-INT transmission format to set the number of values to send for each sensor (E.G. If set to 32 and 4 sensors are sending data, then a total of 128 data values are sent), other formats will use the NUM VALUES defined in the random parameter blocks in the setup. The number entered here will also set the default value when placing a random parameter block into the setup for BIN-NONINT format.

Self-Timed Test

The Self-Timed Test dialog is used to make a test transmission, see the selected format of a self-timed transmission and see the detailed status of the transmitter. Pressing the Send button makes test transmissions. Before pressing *Send*, Satlink must be set up with valid information on both the Satlink dialog and Satlink self-time dialogs. Test transmissions should only be made on special test channels, or with the Satlink connected to a dummy load. Otherwise, the transmission may interfere with other stations. The test message that will be sent is displayed in the text box to the left of the send button. Change the message by selecting custom and then changing the message using the ... control.

If the setup has been entered, this dialog will display the Current Message that would be transmitted if one were sent by the system. Along with the message, the dialog displays the number of characters in the message and the amount of time that would be needed to make the transmissions. These will be useful things to examine to help make sure the set-up is correct.

To see the detailed status from the transmitter, press the Status button.

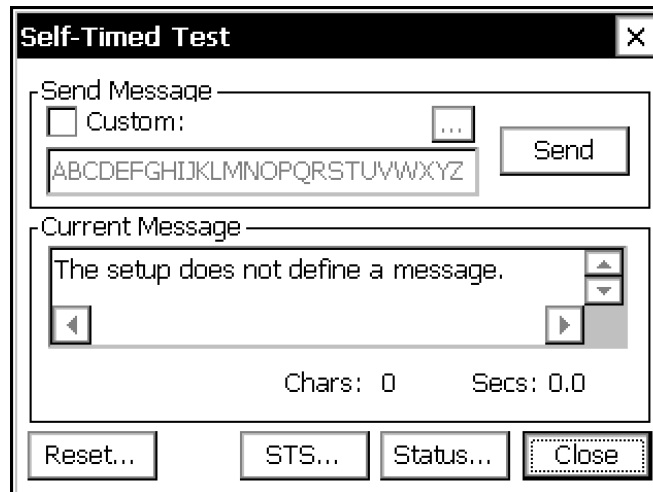

Pressing the “Reset” button will send a command to the Satlink to reset (reboot). This might be necessary in the rare case where the Satlink has a problem that can only be cleared by reset, but no one is at the station to cycle power.

To send a Send-to-Sutron test message, press the *STS...* button. The following dialog is displayed allowing an STS transmission to be made.

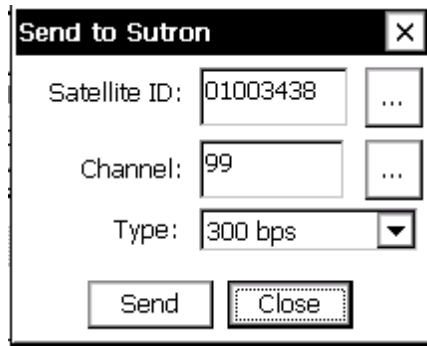

Random Test

The Random Test dialog is used to make a test transmission, see the selected format of a random transmission and display the detailed status of Satlink. Pressing the Send button makes test transmissions. Before pressing *Send*, Satlink must be set up with valid information on both the Satlink dialog and Satlink random dialogs. Test transmissions should only be made on special test channels, or with the Satlink connected to a dummy load. Otherwise, the transmission may interfere with other stations. The test message that will be sent is displayed in the text box to the left of the send button. Change the message by selecting custom and then changing the message using the ... control.

If the setup has been entered, this dialog will display the Current Message that would be transmitted if a random message were sent. Use the control next to Group to select which random group to see formatted. Along with the message, the dialog displays the number of characters in the message and the amount of time that would be needed to make the transmissions. These will be useful things to examine to help make sure the set up is correct.

To see the detailed status from the transmitter, press the Status button.

Pressing the "Reset" button will send a command to the Satlink to reset (reboot). This might be necessary in the rare case where the Satlink has a problem that can only be cleared by reset, but no one is at the station to cycle power.

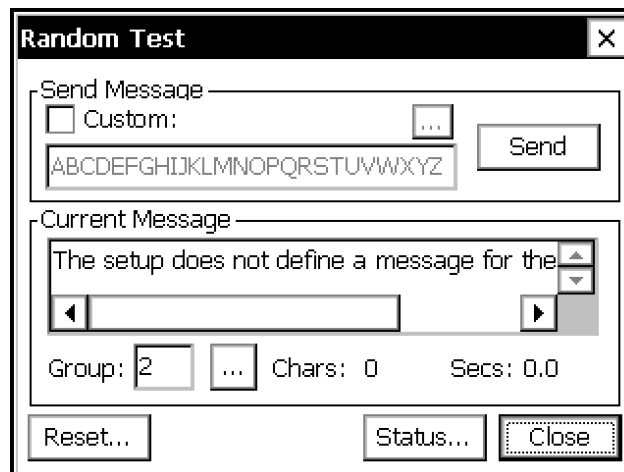

Satlink Status

Satlink keeps a detailed status of its present and past operations. The Xpert will display this information in the Satlink Status dialog.

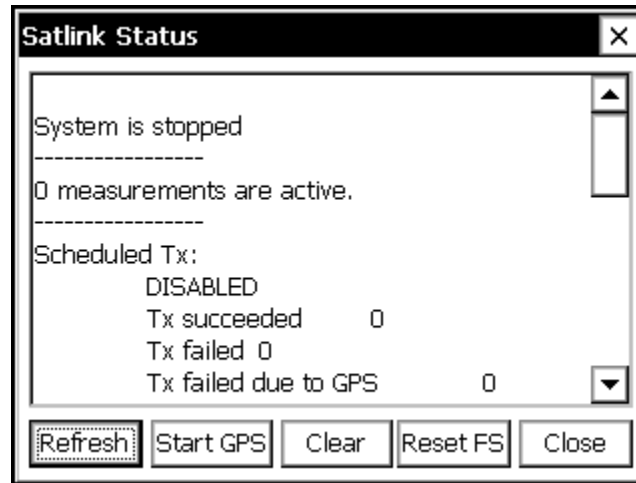

The *Refresh* button is used to update the status data displayed. The *Start GPS* button is used to manually start a GPS Sync session (note, Satlink typically manages GPS sync for you). The *Clear* button is used to command Satlink to clear its status counters and error messages. The *Reset FS* button is used to command Satlink to reset its failsafe. Press *Close* to close the dialog.

Self-test

The *Self-test* branch in the Setup tab is used to manage the self-test routines built into the software. Self-test runs either at startup or when the RUN button is pressed in the dialog. When it runs, a file named test_results.txt is created as a place to preserve the test results. As long as this file exists in \flash disk, the self-test routines will run each time the system starts and will continue running until stopped by the user.

The self-test routines prompt for user input or acknowledgment at several points in the test. If there is no user input, the tests will repeat automatically. At the end of each test cycle, the system prompts to repeat the tests or exit. The user is also given a chance to delete the test results file, which will prevent the tests from being run again on the next system start.

The following tests are performed each time SelfTest executes:

Power Consumption: provides opportunity for user to measure power consumption while the system is in its deepest sleep.

Verify RTC Communication: verifies communication with external RTC.

Verify Physical Memory: verifies the correct amount of memory is present.

Verify Flash Disk: verifies the correct amount of storage memory is present.

Verify Watch Dog: verifies the watch dog timer counter is counting within range.

Verify COM ports: verifies com port operation.

Verify I2C Devices: verifies expected I2C devices are present (test on Xpert requires presence of at least one I/O module to pass).

Verify Battery Voltage: verifies battery voltage is 12V +/- 2V.

Pressing the *Edit* button with the SelfTest branch selected brings up the following dialog that controls what optional tests are to be run.

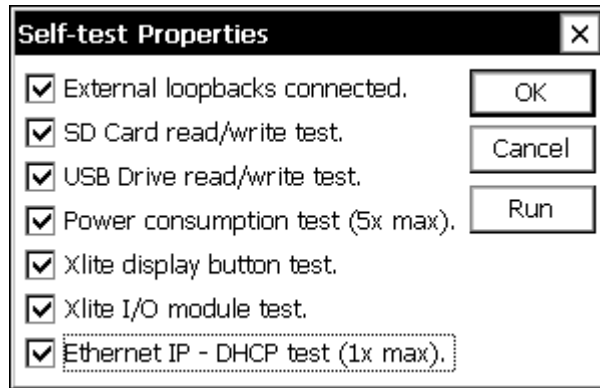

External loopbacks connected – The system expects the following:

Null modem cable connecting COM2 and COM3.

Null modem cable connecting COM6 and COM7 (if present).

Null modem cable connecting COM8 and COM9 (if present).

External loopback connector on COM4, which connects RTS to CTS, DTR to DSR, and Tx to Rx (Xpert only).

SD Card read/write test – Make sure an SD card is inserted when running this test.

USB Drive read/write test – Make sure a USB thumb drive is inserted when running this test.

Power consumption test – All test runs begin with this test. The system puts itself into deep sleep for 1 minute so that the user can measure power consumption. Note: this test only runs for up to 5 consecutive iterations.

Xlite display button & I/O module tests: Xlite only.

Xlite I/O module test – This test requires a factory test header and is not normally run in the field.

Ethernet IP from DHCP test – This test requires the unit be connected to a network providing DHCP services. Note: this test only runs for one iteration.

Setup File

The *Setup File* branch in the setup tab is used to manage the setup file containing the system setup and configuration. The setup file contains all of the system's settings except for station name, Xpert display contrast settings, and log export historical data.

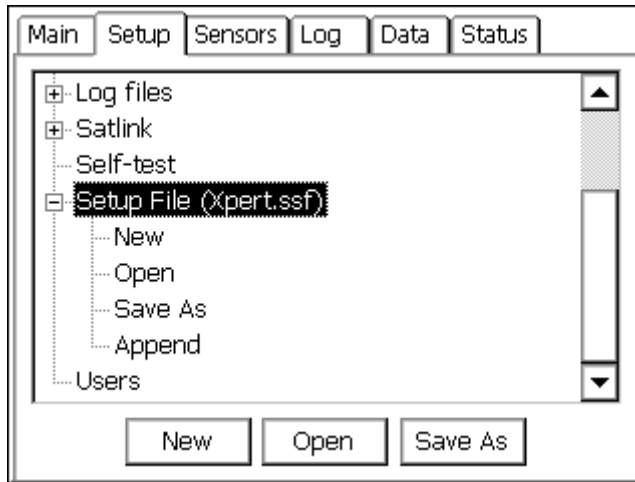

New

The *New* option is used to reset all settings to a default state with a name specified by the user. After selecting *New*, the system prompts for the name of the new setup file. If the file specified exists, the system warns that it will be overwritten.

Open

The *Open* option is used to open existing setup files.

Save As

The *Save As* option is used to save current settings to a file with a different name. A large number of setups can be stored, limited only by the available Flash memory. To save a setup under a new name, click the *Edit* with *Save As* in the Setup tab selected. The following window will appear:

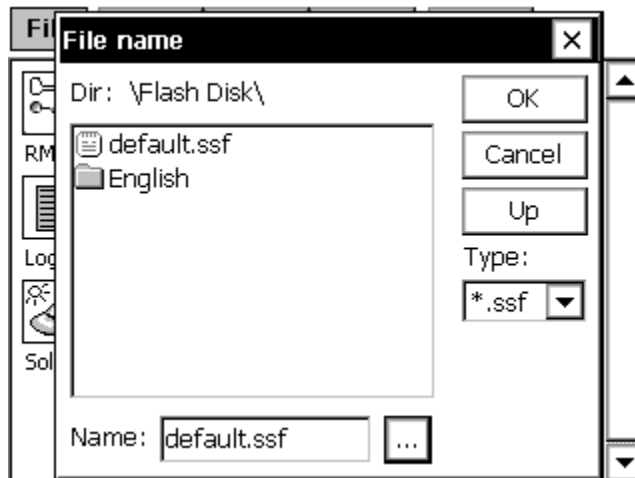

The *Up* button is used to move up one level in the directory tree structure. Use it to get to any installed storage cards, which will be displayed as one of “SD Card” or “USB Card”. To change

the filename for the setup file being saved, click the change button (“...”) and using the virtual keypad to enter the desired name of the file.

Append

The *Append* option is used to append blocks from another setup file to the current one. Note that only blocks are appended. No other settings from the setup file selected are imported (e.g., Satlink settings remain unchanged after appending a new setup file).

Note: The system saves the setup file as changes are made so that it is never necessary to perform an explicit save (and, hence, there is no *Save* option).

SNTP

The *SNTP* branch of the setup tab is used to configure time synchronization with an NTP network time source. Pressing *Edit* with this branch selected brings up a window with configuration options.

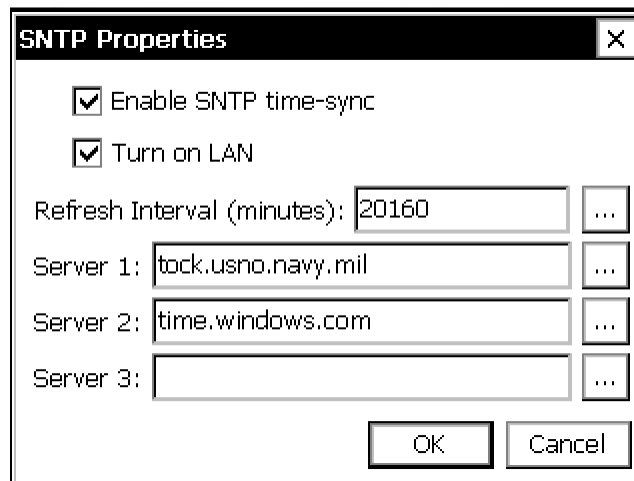

When *Enable SNTP time-sync* enabled, the logger attempts to set system time using the NTP time source defined by *Server 1*. If *Server 1* can't be reached for some reason, *Server 2* is tried. Likewise, if *Server 2* is unavailable, *Server 3* is tried. The attempts to set system time occur at the interval specified in *Refresh Interval*. The default setting of 20160 minutes equates to once every 14 days. The minimum value for this setting is 5 minutes.

When *Turn On LAN* is checked, the logger will turn on the LAN when SNTP is enabled. Note: power to the LAN is continuous, not just when the time synchronizations occur.

Note, when deploying the logger on a network having public access, it's recommended that additional security be utilized such as an external VPN Firewall (virtual private network) that would restrict access, and provide encrypted and secure communications.

Users

The *Users* branch of the setup tab is used to manage the list of user login accounts to the system. Pressing *Edit* with this branch selected brings up a window with all the users accounts that have

been added so far (it will be blank if none have yet been added.) From here, an account can be added, modified, or deleted.

The columns provide a summary of the settings including the name, group, timeout, and the access rights that have been permitted. In the screen below Susan has been placed in the data Retrieval user group. She may leave the unit inactive for 1 minute before it will time out. She has been granted access rights to the **C**ommand line and **G**ui. Franco has been placed in the Setup user group and hence is allowed to change the setup, upgrade the unit, transfer files, etc. He may leave the unit inactive for up to 10 minutes before his session will timeout. He has been granted access rights to the **C**ommand line, **G**ui, and he may access the unit via **T**CP/IP (LAN).

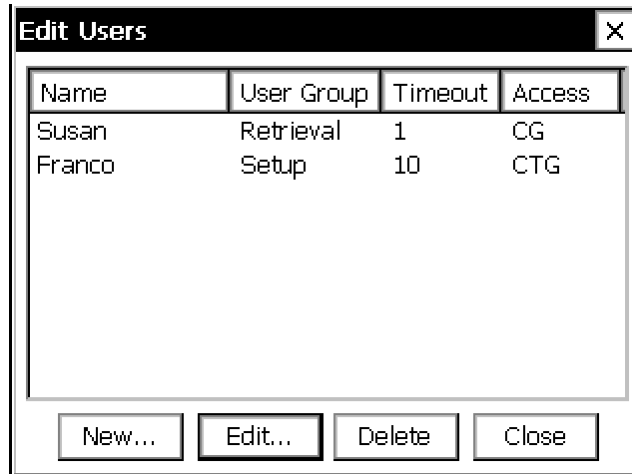

The screenshot shows a window titled "Edit Users" with a close button (X) in the top right corner. Inside the window is a table with four columns: "Name", "User Group", "Timeout", and "Access". There are two rows of data. Below the table are four buttons: "New...", "Edit...", "Delete", and "Close".

Name	User Group	Timeout	Access
Susan	Retrieval	1	CG
Franco	Setup	10	CTG

Pressing *New...* or *Edit...* brings up a user properties window. This window has blanks for user name, password, user group, access rights, and a timeout.

If no password is desired for that user, simply leave the password spaces blank.

The user group determines what sort of access the user is allowed. Normally either Retrieval and Setup access are selectable, but Custom groups may also be enabled by certain SLLs or Basic Programs.

A timeout period may be selected for the user to determine how much time with no activity must pass in order to automatically log-out the user.

Starting with Xpert v3.2, Access Rights may also be assigned. These allow the user to be restricted to accessing only the Command Line, TCP/IP, SSP, or GUI capabilities of the unit, depending upon what's checked. For example, if you wish to access the GUI via Xterm over a network you'd enable GUI and TCP/IP. If you wish to access the command line via telnet over the network you'd enable Command Line and TCP/IP, and disable SSP. If you want to permit automatic data collection from XConnect you'd need to enable SSP and perhaps TCP/IP.

If you wish to place the Xpert on a public network such as the internet, it's recommended that additional security be utilized such as an external VPN Firewall (virtual private network) that would provide encrypted and secure communications.

The screenshot shows a dialog box titled "Edit User". It contains the following fields and controls:

- User Name: Text box containing "Susan" and a browse button (...)
- Password: Text box containing "****" and a browse button (...)
- Confirm: Text box containing "****" and a browse button (...)
- User Group: Dropdown menu showing "Retrieval"
- Access Rights: Four checked checkboxes: "Command Line", "TCP/IP", "SSP", and "GUI"
- Timeout: Dropdown menu showing "1 mir"
- Buttons: "OK" and "Cancel"

SENSORS TAB

The Sensors tab shows all the sensors that have been added to the system, the sensor addresses, the last data value sampled from each sensor, and the quality of these last sampled values. The page is automatically refreshed every 5 seconds. Note that just because a sensor has been physically attached to the system does not mean the system software is aware it is there. Adding a new sensor or other input to the system is done through the *Setup* tab.

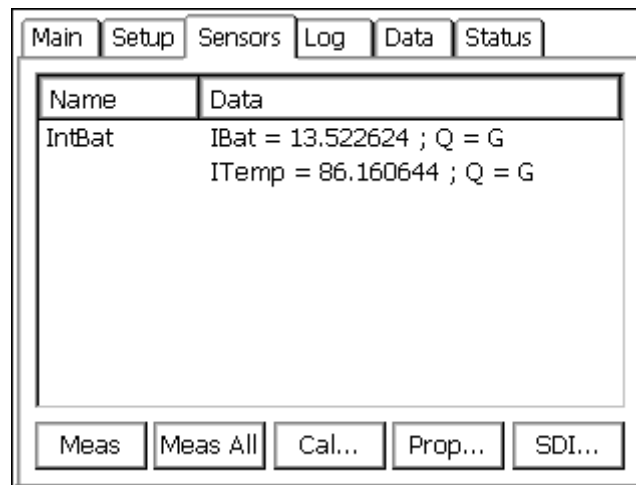

Live Measurements

To get a live reading from any of the sensors, first select that sensor in the Sensors window and then press the *Meas* button. To get a live reading from all the sensors, press *Meas All*. Regularly scheduled sampling always gets priority over live readings, which might result in a live reading taking several seconds to be returned.

Note: If recording is not on, then attached I/O modules have not necessarily been initialized. As such, measurements may not be accurate.

Calibration Sequences

The Calibrate button runs a calibration sequence on the selected sensor if one had been previously setup. The calibration procedure writes a message to the log to document any change that is made. [See SETUP BLOCKS/*sensor* descriptions to determine if a calibration method exists]

Properties

The *Prop...* button brings up the properties page for the selected sensor. This allows sensor values to be changed without having to go to *Setup* (note, however, settings cannot be changed without turning recording off).

Sending SDI-12 Commands

The *SDI...* button brings up a window that can be used to send commands and view responses from any SDI-12 sensor attached to the system, as shown below. Note that sampling from all sensors will be stopped while in this window.

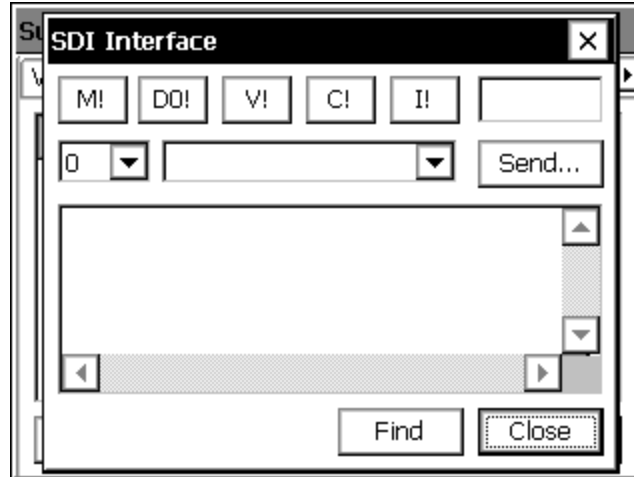

The SDI-12 window has a box for selecting the address of the device to communicate with and also a *Send* button that allows you to create SDI-12 messages (when using Xterm, you must enter longer SDI-12 commands using the Send dialog, rather than by direct entry into the combo box). There is also a drop-down menu with the last 5 commands to select and send one of the last commands that were issued. The larger text box displays the history of the previous commands and replies from SDI-12 communication.

The SDI window has some shortcut buttons for sending the most common commands. These commands are M (measure), D0 (data), I (information), V (verify) and C.

A timer runs whenever a response is received on SDI-12. This timer is displayed and shows the number of seconds that have elapsed since the last response. The user can use this timer to know when to issue D commands in the event that the SDI-12 device requires a long time to perform the measurement or function. The user may also monitor the text box for the sensor's service request prompt.

This window also has a *Find* button. Pressing it will cause the Xpert to cycle through all SDI addresses and display any sensors it finds. A count of the number of sensors found will be displayed as the operation progresses. The find may take ten seconds to run as there are over sixty SDI-12 addresses to check. When the unit finds a sensor, it will issue the I (identification) command and show the results of the I command in the command history text box.

When more than one SDI port is available (e.g., when using the optional SLL "RS485SDI.sll"), the window contains a *Port...* button that can be used to select the active SDI port.

When exiting the SDI window, the software will prompt to see if Recording should be restarted if it was stopped on entry.

DATA TAB

The Data tab shows all the data values in the Xpert that have been tagged with either a Coms Tag or FieldVar setup block. If this window is empty, it means that neither Coms Tags nor FieldVars were used in the setup. The data in this window are the values that will be transmitted in response to a request for current data. If the data results from a Coms Tag, and the tag block is connected to an Alarm block, the Alarm status will show up under the column labeled “Alarm”.

This window provides three controls: *Refresh*, *Measure* and *Change*. *Refresh* updates the window with the latest information. When the current selection is a Coms Tag, *Measure* causes the system to make a live reading of the sensor to which the Coms Tag is connected (see Note below), and *Change* alters the current value for the value that is displayed (*Change* will also kickback the value to blocks to which it is connected, e.g., if a Coms Tag is connected to a Constant Block, you can use change to alter the value of the constant). When the current selection is a FieldVar, *Measure* has no effect and *Change* changes the value of the displayed property.

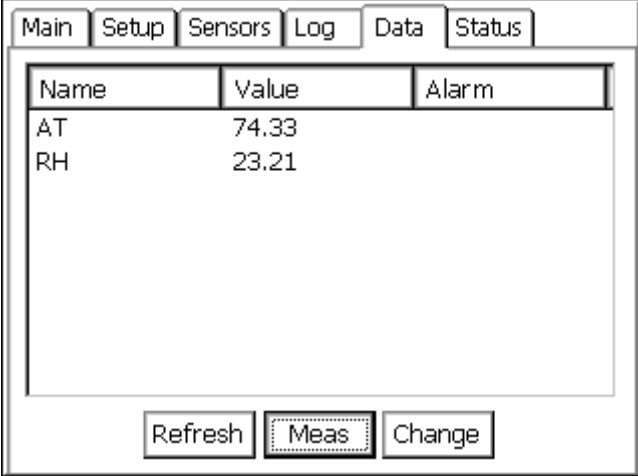

Name	Value	Alarm
AT	74.33	
RH	23.21	

Refresh Meas Change

Note: Coms Tag blocks can only “measure” sensors with which they are inline, if there are no “active” blocks between the Coms Tag and sensor block. Generally speaking, this means the Coms Tag must be connected after the sensor block, and **before** any Measure, Average, or other active block (an “active” block is one that initiates a measurement, and typically has a darkened border in the graphical setup).

The FieldVar setup block, in conjunction with the Data tab, provides a way to access often-changed properties from multiple blocks in the setup in one convenient place. To understand FieldVars, some knowledge of the way the Xpert is set up is needed. The graphical setup is discussed in detail in the next chapter, but for the purposes of this discussion, let’s look at a sample setup screen:

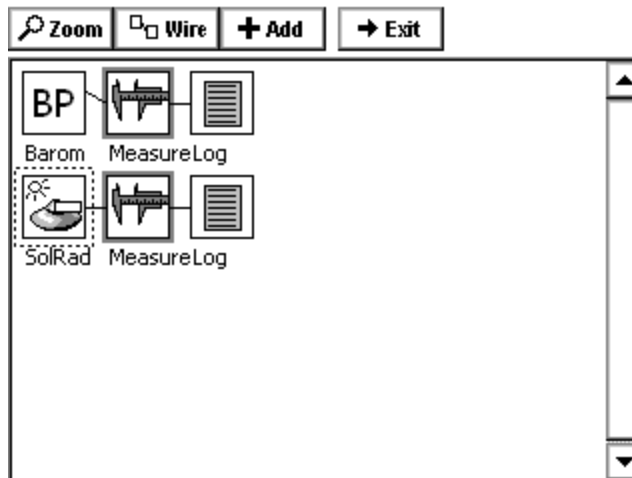

Each block in the Xpert setup represents something different. In the above setup, the solar radiation (SR) and barometric pressure (BP) blocks represent physical sensors, the measure blocks represents processing operations where the data is being regularly sampled, and the log blocks represent the files in which data is being stored. Data can be thought of as flowing from the left side of the screen to the right.

Each setup block has a properties window that is used to view or change its properties. These windows are brought up by clicking an icon and then selecting *Edit Properties* from the menu that pops up. The properties window for the Measure blocks looks like this:

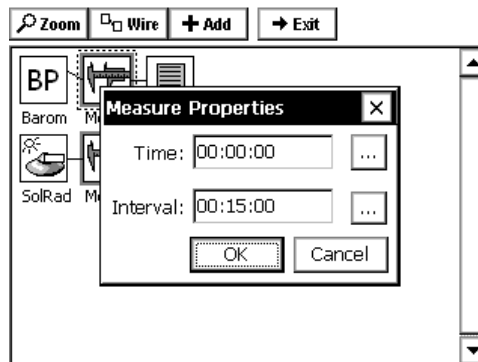

Let's say we plan to change the sampling intervals for the SR and BP sensor fairly often, and don't want to go into the setup each time we want to change them. Or, perhaps, we want to give technicians that do not have access to the setup screen the ability to change these two intervals. These are cases where it makes sense to use FieldVar blocks.

Using the Add button in the Setup screen (described in the next chapter) we have now attached a FieldVar block to each measure block:

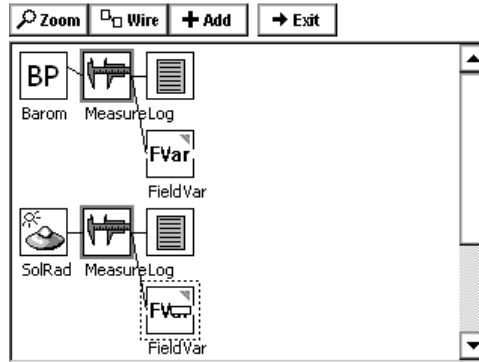

The properties window for either of these FieldVar blocks looks like this:

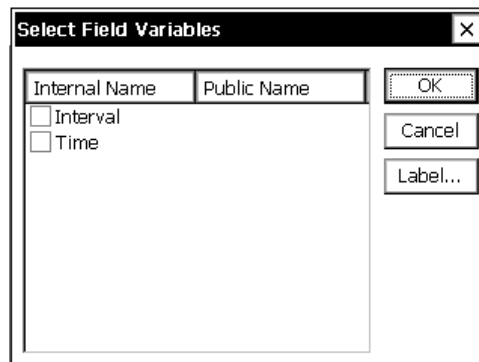

Listed are the two modifiable properties for the Measure block. To add *Interval* to our View Data tab, check the box next to *Interval*. Then click on the word *Interval* to select it and click *Label...* to give this property a *Public Name*. For this example, assign the name “BP Interval”. *Public Name* must be unique in the system in order to uniquely identify the referenced property. If no *Public Name* is specified, it defaults to *Internal Name* when OK is pressed, but will display an error if that name is not unique. To continue this example, click OK and then follow the same procedure with the other Measure block to assign its interval a *Public Name* of “SR Interval”.

Now when we exit the Setup screen and go back to the Data tab, we see the two interval properties for our measure blocks as shown below:

Name	Value	Alarm
BP INTERVAL	00:15:00	
SR INTERVAL	00:15:00	

To change either property, simply select the one to modify and click *Change...* to enter a new value.

LOG TAB

The Log window is used to display data from a log file. The Xpert can support logging to many different log files at one time. A log file can be viewed even if it is open and being logged to.

The Log tab is meant mainly to allow viewing of small sections of the log in order to validate sampling or to view recent values. To view large sections of the log or to perform data analysis, the log file should be retrieved from the unit. This is done using the *Export* button.

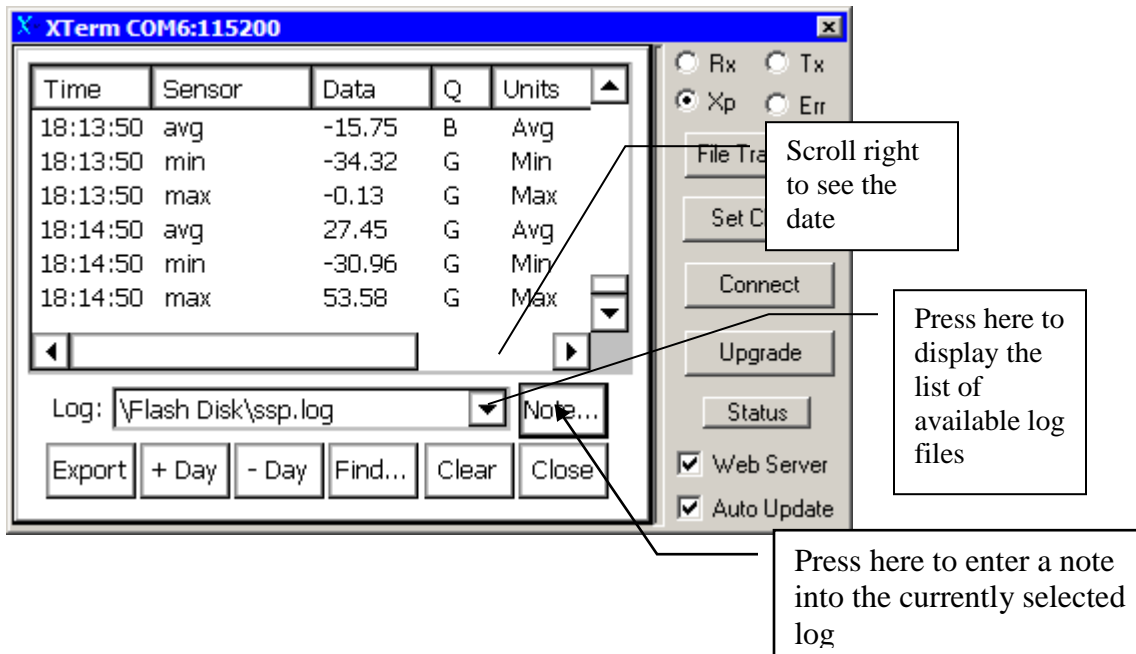

Column Labels

Time

This is the timestamp for the data in the log. This time is normally the time when the data was measured. In the case of an average, the time will be the time of the last measurement. In other cases, the time will be the time the computation was completed.

Sensor

This is the name of the sensor/signal that the logged value came from. These names are user-entered in the properties window of each log block in the *Setup* tab. These should have unique names so that a charting or analysis programs can treat the values differently.

Data

This is the value of the data point. The value is shown with a user-defined number of digits to the right of the decimal point. The user can set this precision in the properties window of each log block in the *Setup*.

Q

This is an indication of the quality of the data. It is set to G (good) or B (bad) by the input module making the measurement. Other modules processing the data can also modify this quality.

Units

These are the units for the measurement. The units are generally set by the Sensor block (in the Setup Diagram), but can sometimes be determined by a Processing block.

Date

This is the date for the timestamp. It is displayed in the format selected by Set Date/Time in the Main tab. Because of the small screen size, the column for the date is hidden. Use the scroll bar to see the date.

Selecting Log File

Use the pull down menu next to *Select Log* to show all the log files in the system that are available for viewing. Log files are created, modified and deleted under the *Setup* tab. To change what sensor data gets directed to a certain log, the properties for that log must be modified in the *Setup* screen.

Navigating the Log

The log file can be navigated either with the scroll bars on the sides of the Log window or with the buttons at the bottom of the display.

+Day, -Day

The buttons *+Day* and *-Day* can be used to jump ahead or back one day's worth of data.

Find...

The *Find...* button can be used to search for the data logged near a certain date and time.

Clearing the Log

Pressing this button causes contents of the log file to be erased. The system will ask for confirmation before doing this. Note that this erases the contents of the log file but does not delete the log file itself – this can only be done under the *Setup* tab. Data will continue to be stored to a cleared log file if logging to that file is active as defined in the *Setup*.

Entering a NOTE

To enter a note into the log, first select the log where the note should be placed (typically the system log, as most users don't want notes in their data logs), press the "NOTE" button and enter the text to be added. Then press OK in the upper right corner to enter the note, or press X to cancel entering a note. This is a useful way to document site visits, or to note any issues found while on a site visit.

Export

This button is used to retrieve the log file. Clicking this button will cause the system to lead you through the steps to create an ASCII file of the data in the log. The log file is a compressed file. If you were to try to view the file, you would see gibberish because of the compression. Converting the file to ASCII allows the contents of the file to be viewed.

As a part of this Export process, you are asked to specify a destination for the file. If you do not get a prompt to save the file on the PC, you should change the directory for the file to be \Temp. To do this, press the button labeled *Up* and then select *Temp*. If you were to select \flash disk\ as the destination directory, you could fill the flash disk with the new file and shut down the system.

If the Xpert contains a storage card (USB or SD), then when the button labeled *UP* is pressed, you will be able to select one of “\USB Card” or “\SD Card” as a destination.

When you press the Export button, the following dialog is displayed:

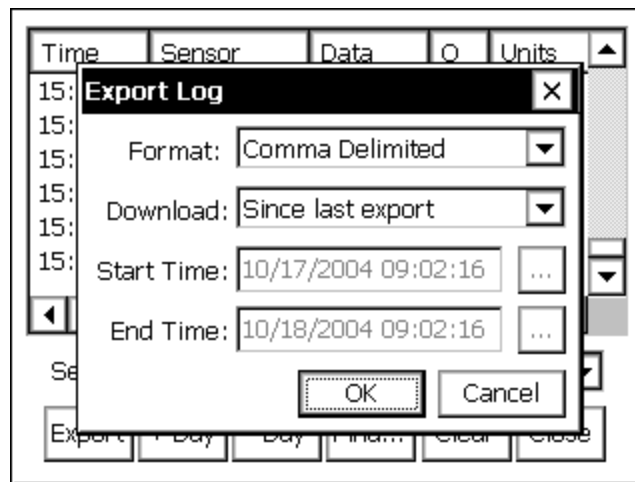

This dialog allows you to define what the exported log file should look like.

The *Format* options are: Comma delimited, Tab delimited and Fixed Column. The comma delimited format works well with spreadsheets. The Tab Delimited and Fixed Column formats can work well when printing.

The *Download* options are defined as follows:

- Since last export - When this option is selected, the system exports only data that is more than the time of the last log export. If the log has never been exported, the system exports the entire log.
- Start time to end time - When this option is selected, the system exports only the data that has a timestamp between the dates and times specified in *Start Time* and *End Time*.
- Start time to end log - When this option is selected, the system exports only the data that has a timestamp between the time specified in *Start Time* and the end of the log.

Start log to end time - When this option is selected, the system exports only the data that has a timestamp between the start of the log and the time specified in *End Time*.

If you are using XTerm and press Export, the software will automatically transfer the file to your PC without creating a copy of the file on the Xpert.

STATUS TAB

The status tab displays detailed status information from the Xpert. The data displayed includes the status on each I2C module, any communication modules, and the system in general. To update the status menu, press the *Refresh* button.

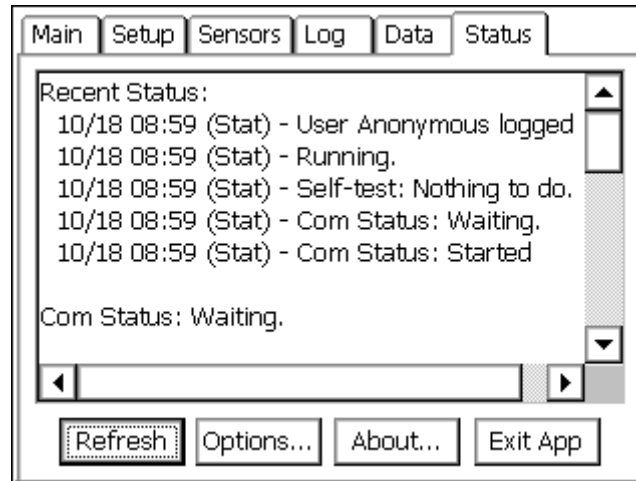

Select the *Options* button to access status reporting options. The Status Options allows the user to configure where status and debug messages should be sent. Note that status messages are automatically stored in the system log.

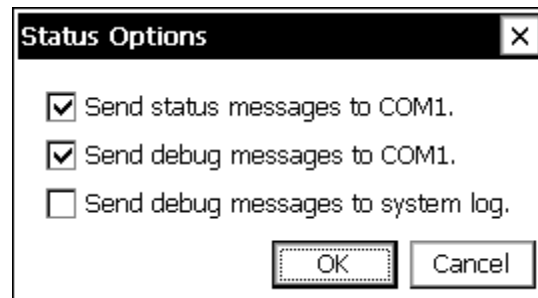

To access the about dialog, press the *About* button. The About dialog displays version and copyright information for the Xpert executable and libraries. This dialog also displays the serial number of the unit.

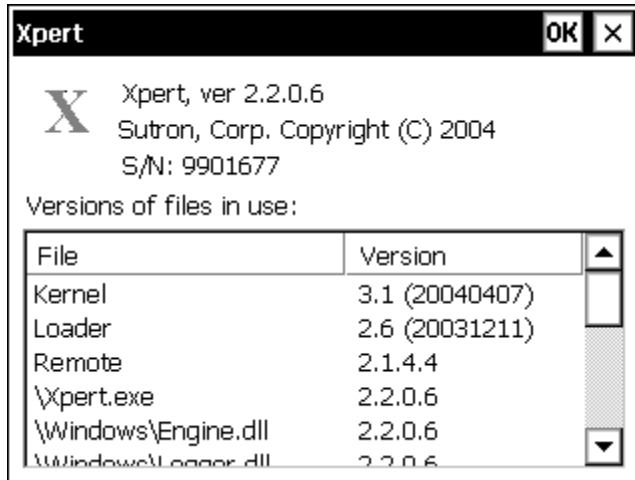

The *Exit App* button is used to stop the Xpert program. Normally this is only done when you want to update the program itself. When the Xpert program is stopped no data collection or recording will take place. The software warns with the message “Warning, this will terminate the Xpert program. All data and setup not in flash will be lost. Are you sure?”

USING STORAGE CARDS

Each Xpert can support USB and SD storage cards. These storage cards can be used to either expand flash disk space for data logs, to upload/download setups, or to download log files. Custom applications may add other functionality.

NOTE: Storage Cards must be formatted FAT16 or FAT32, not NTFS.

Working with a storage card is similar to working with the internal \flash disk\ folder. Whenever specifying the location to place files, press the UP button (see below) to see a root directory structure. The storage card will be shown as “USB Card” and “SD Card” folders. Double click the folder to select it.

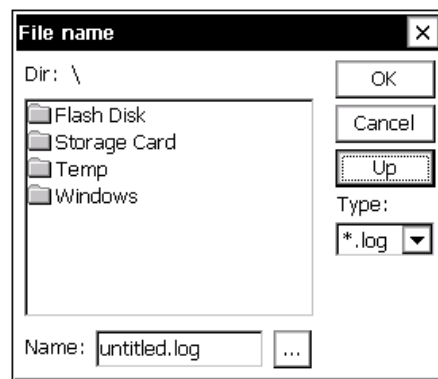

Expand Log File Capabilities

A storage card can be used to increase the amount of log file flash disk space from the built in 32MB (shared) to the size of the storage card.

To do this, follow these steps:

1. First, place the card into the appropriate slot.
2. Then go to the Setup tab
3. Click LOG, then EDIT
4. Click the NEW button
5. Click the ... button next to filename
6. Click the UP button, and then double click into the storage card's folder
7. Enter a file name for your log
8. Click the OK button back to the LOG FILE PROPERTIES box
9. Don't forget to increase the size of your log file!
10. Now click OK and the log file will be created on the storage card

To use the log on the storage card, select the log file on the storage card folder from the LOG block properties.

Note: the minimum log size is 2048 bytes. The maximum log size is the lesser of 1) 2 billion bytes, or 2) the free space available on the storage medium minus a small safety buffer (32k for storage cards, 192k for Flash Disk).

Upload/Download Setups

Setup files can be stored on storage cards, just as they are stored on the local flash disk. To do this, follow these steps:

To save a setup Using Xterm or the touchscreen-

1. Place the card into the storage card slot
2. Go into the SETUP tab
3. Select the FILE drop down menu to do a SAVE
4. From the file selection menu press the UP button
5. Then double click into the storage card folder (USB Card, SD Card)
6. Give the setup a name, or leave it at the default, then click ok.

To open a setup using XTERM or the touchscreen-

1. Place the card into the storage card slot
2. Go into the SETUP tab
3. Select the FILE drop down menu to do a OPEN or APPEND
4. From the file selection menu press the UP button
5. Then double click into the storage card folder (USB Card, SD Card)
6. Click on the setup name to open, and then click ok.

Download log files

Log files can be retrieved from a unit onto a storage card. To do this, follow these steps:

To retrieve the log using Xterm or the touchscreen

1. Place the card into the storage card slot
2. Go into the LOG tab
3. Click export, choose a data format, then click OK
4. Click the UP button
5. Then double click into the storage card folder (USB Card, SD Card)
6. Give the file a name, or use the default,
7. Select the download format, then click OK

Chapter 4: Graphical Setup Diagrams

OVERVIEW

This chapter will discuss the way in which to create and modify graphical setup blocks. Determining when to use the graphical setup versus the Ezsetup measurements is discussed in detail in chapter three, but the simple rule is this: If the sensor is measured, or averaged only, then use EzSetup Measurements, if additional processing is needed, or the data is needed for calculating other parameters, use the graphical setup.

The graphical setup blocks screen is accessed by going into the Setup tab and clicking on either the Graphical Setup tree and clicking EDIT, or by selecting one of the graphical sensors under the Graphical Setup tree and clicking EDIT. Selecting Graphical Setup and clicking EDIT will show all sensors configured in a graphical manor, selecting only one of the graphically setup sensors will show that sensor and all processing related to that sensor only. Some users find that viewing the whole Graphical setup can be overwhelming, therefore it is recommended to only select/create one sensor at a time when setting the system up.

AN EXAMPLE SETUP DIAGRAM

Pressing *Edit* with the *Graphical Setup* item highlighted on the *Setup* tab brings up a screen similar to the one shown below. The tabs at the top of the screen have been replaced with the buttons *Zoom*, *Wire*, *Add*, and *Exit*, with the rest of the screen reserved for placing and connecting setup blocks. From this screen, we can get a quick view of where data is coming from, how it is getting sampled and processed, and where it is going. Below, for example, we see:

A parameter from the barometric pressure sensor is being periodically sampled and its maximum or minimum being stored to a log at some rate; and,

Solar radiation is being regularly sampled, logged and periodically transmitted via satellite to a main station.

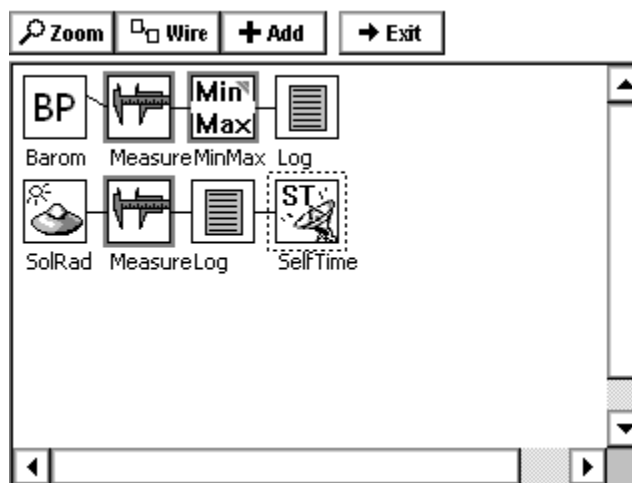

Block Categories

Setup blocks come in general categories – *Input*, *Processing*, *Logging*, *Telemetry*, *Miscellaneous*, and *Output*. Four of these types of block are represented above. On the left are the *input blocks* representing barometric pressure and solar radiation sensors hooked to the system. Next to them are the *Measure* and *MinMax processing blocks* which request and/or perform operations on the data from the sensor blocks. Note how these two blocks have darkened borders. This is an indication that the block is “active”, i.e., that it initiates data flow through a chain of blocks.

After the *Measure* and *MinMax* blocks come two *log blocks*, which indicate where the data is being stored. Finally, there is a *telemetry block* which indicates how the data is being transmitted.

Blocks of a certain type are not restricted to a particular column in the display, but data does always flow from the left side of the screen to the right.

Block Inputs and Outputs

Setup blocks are hooked together via their inputs and outputs. A block with an input can *accept* data from another block and a block with an output can *send* data to another block. To see this more clearly, we’ll zoom in on our example using the *Zoom* button on the top of the screen:

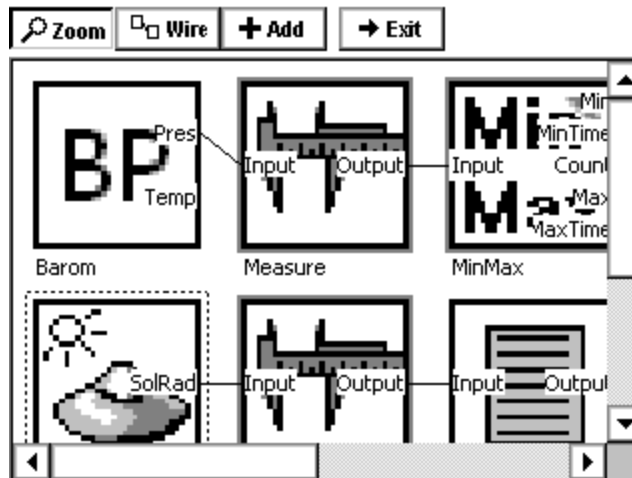

We can now clearly see the inputs and outputs each block has available along with which are being used and which aren't. It is now evident, for example, that only the *pressure* from the BP block is being sampled (not the temperature) and that only the *maximum* value of this pressure is being logged.

Block Connectability

The graphical setup allows any two blocks to be connected together as long as the first has an output and the second an input. However, this does not necessarily mean that any constructed setup will work. For example, even though the system will allow a sensor block to be hooked directly to a log block, no data will necessarily be logged, unless there is an "active" block to control when processing takes place ("active" blocks are those with darkened borders; see the example in the next section).

Active Blocks and Push/Pull

"Active blocks" are blocks that make the other blocks connected to them execute (or perform their function). This results in data being pushed and pulled from and into the other blocks. Active blocks always have a darker, thicker border, so they are easier to recognize.

Active blocks typically ignore the call to execute and push/pulls from other active blocks. This helps to ensure the system is as determinant as it can be (i.e., this helps to ensure you can figure out who's going to execute, and when).

In the example below, the first Measure block signals the Const block to execute, and then pushes the result into the second Measure block and the lower Log block, L2. The data is logged to L2, but since Measure blocks are active and thus ignore pushes and pulls, the data is not logged to L3.

When the second Measure block executes, it signals the first Measure block to execute, and then pushes the result to L3. When the Measure block is signaled, he simply returns the last known value for Const, instead of measuring anew, again since active blocks ignore push/pull requests.

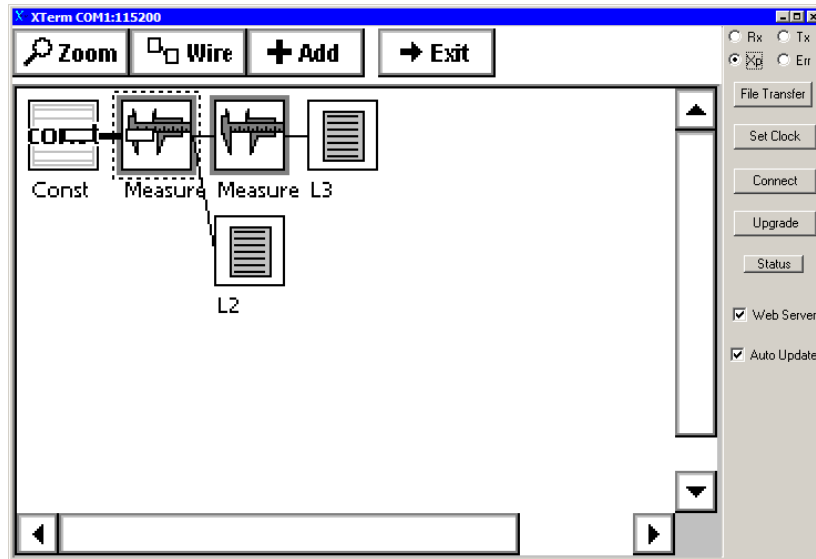

Block Placement

Some setup blocks require specific placements to work properly. Here are some examples:

- ComsTag block: in order for a ComsTag block to be able to retrieve a new (“live”) value from an input sensor, the ComsTag block must be placed after the sensor block, but before any active blocks
- Display block: In order for the Display block to enable front panel calibration for a sensor block, the Display block must be connected directly to the sensor block.
- Any passive (non-active) block with more than 1 input (e.g., XYFunct and Bool blocks): in order to ensure this kind of block operates on data measured in the same frame, and to avoid certain side effects that come from active blocks executing along split paths that rejoin (like logging twice), place the measure block AFTER the block having the multiple inputs.

See Appendix A for constraints of other blocks.

Block Properties

We now know a lot about what is happening with our example setup, but not everything. We don’t yet know, for example, the units the barometric pressure setup is going to return its data in, or how often the solar radiation is going to be sampled, or what log file either data stream will be saved to. For this information, we need to look at block properties.

To view the property window for a block, click the icon for the block once and then select *Edit Properties* from the menu that appears:

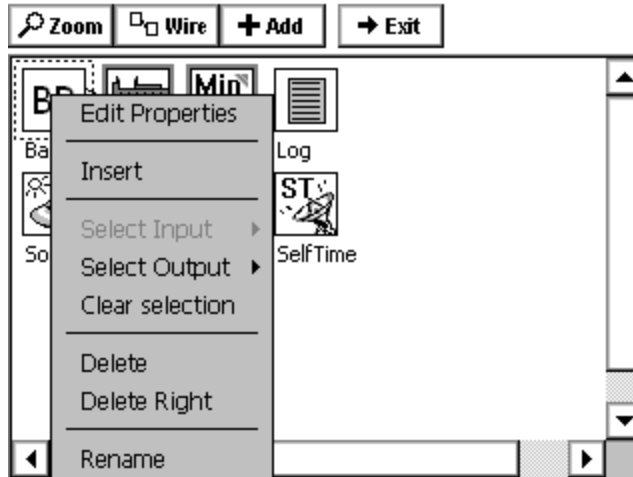

If we do this for the BP sensor block, the following block properties window comes up, revealing the pressure units to be sampled, the SDI address, the averaging time, and the temperature options:

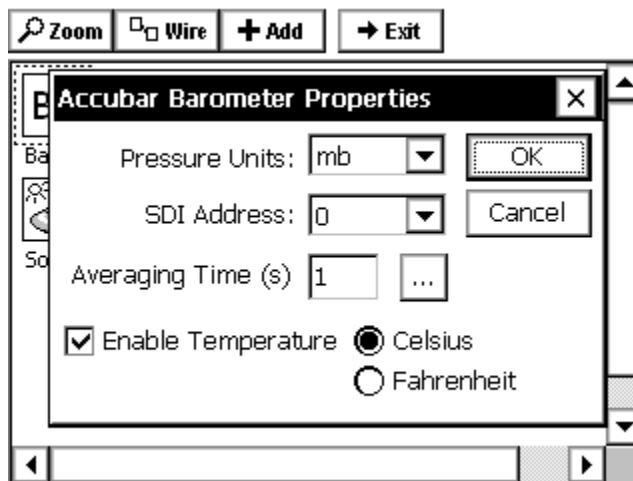

Viewing the property windows for the other blocks in the setup can be viewed in a similar manner. A full description of the properties for each block can be found in Appendix A: Setup Blocks.

CREATING A NEW SETUP DIAGRAM

Now that we have seen an example graphical setup, let's see what it takes to create a small one from scratch. From the Setup tab, highlight [New] and select *Edit*. This will bring up a blank setup screen:

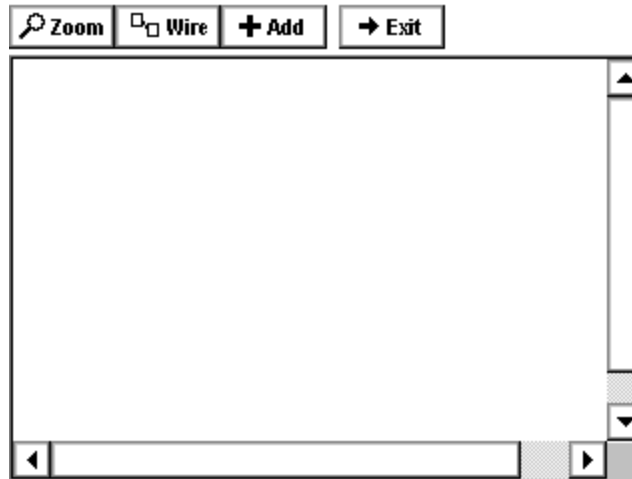

Let's say we've just physically hooked-up two sensors to our Xpert and want to add them to this new setup. One is an RM Young wind sensor, from which we want to log wind speed and wind direction, and the other is a submersible pressure sensor, from which we want to measure water depth.

Adding a Sensor Using the Wizard

Click the *Add* button to add the first sensor. The following screen will come up:

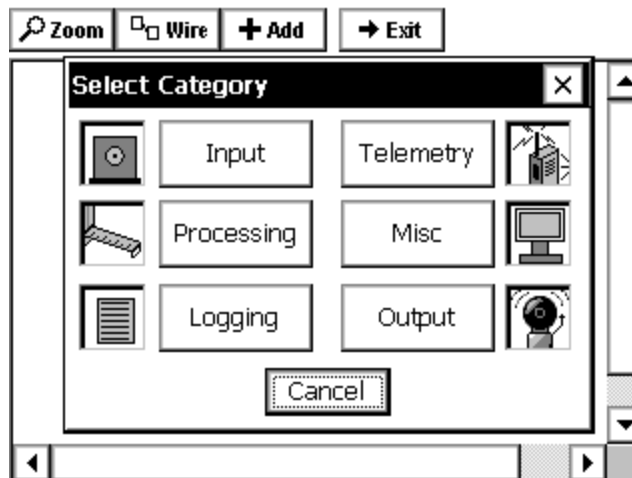

This screen shows the different types of setup blocks. Now click *Input* to bring up a list of the available input blocks:

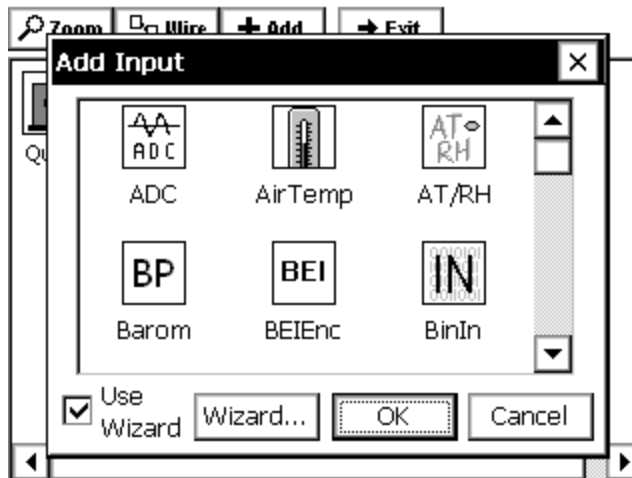

Scroll up or down to find the input block labeled RMYoung. For now, leave the checkbox next to *Use Wizard* checked and click *OK*. Now the main setup display will look like this:

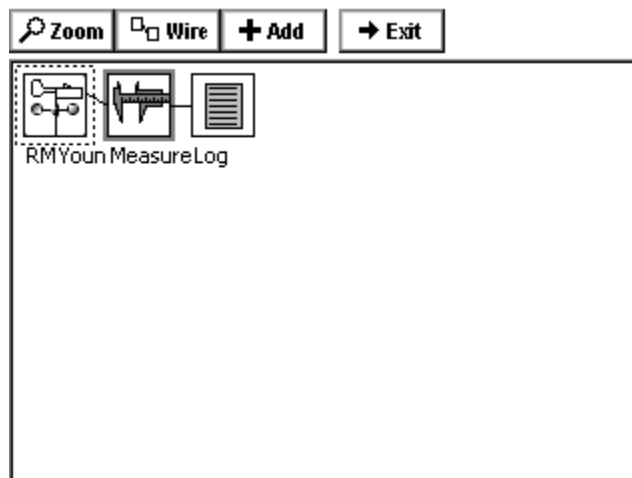

By using the Wizard, we can see that not only has the RMYoung sensor block has been added to the setup screen, but a measure block and log block as well, with connections! The exact blocks that are automatically added with the Wizard are customizable with the *Wizard...* button in the Add Input window above.

Adding Additional Blocks

Looking carefully, we see that only one of the outputs from the RMYoung block will be sampled and logged with this arrangement. Zooming in on this block indicates it is the wind speed output:

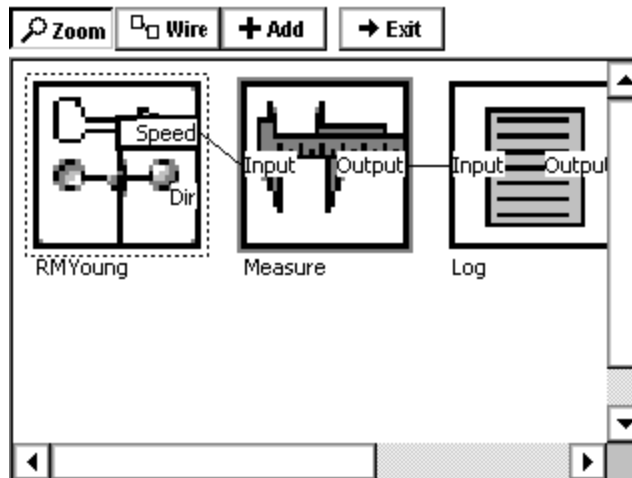

To also sample and log wind speed, we need to create another instance of the measurement and log blocks and connect them to the wind direction output of the RMYoung block. To do this, first: click the RMYoung icon, click *Select Output*, and then (from the slide-out menu) click *Dir* for the direction output:

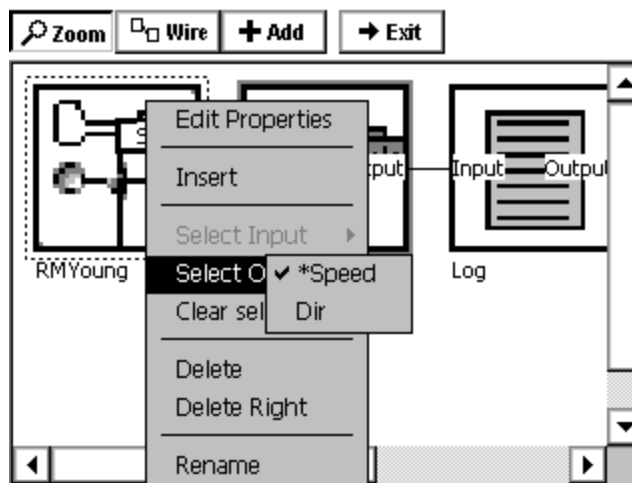

Now click the *Add* button at the top of the screen, click *Processing* to show the processing blocks, select the *Measure* block, and click *OK*. Now we see another measure block has been placed under the first:

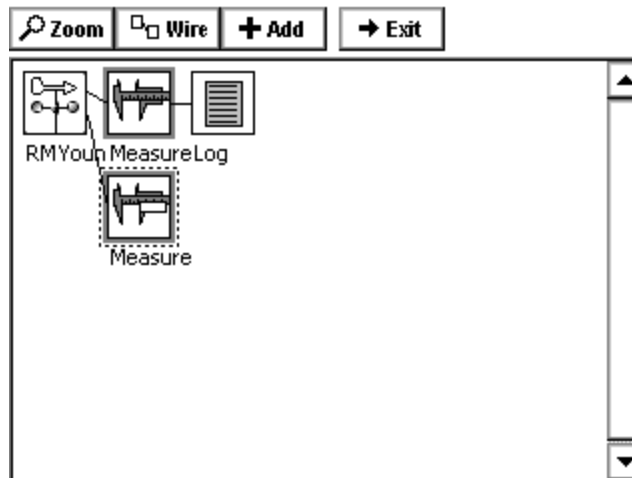

Although it seems as though we would now hook this measure block up the to the log block already placed in the setup, we actually now want to add another log block below the first. This is because a setup blocks input cannot accept a signals from more than one block. However, this results in no loss of functionality as the new log block can be configured to log to the same log file as the previous one.

So, to add this second log block, click the *Add* button, select *Logging* to bring up the logging blocks, select the *Log* block and then click *OK* (we didn't have to select the output from processing as it was already selected from above). Now both of the signals from RMYoung will be sampled and logged:

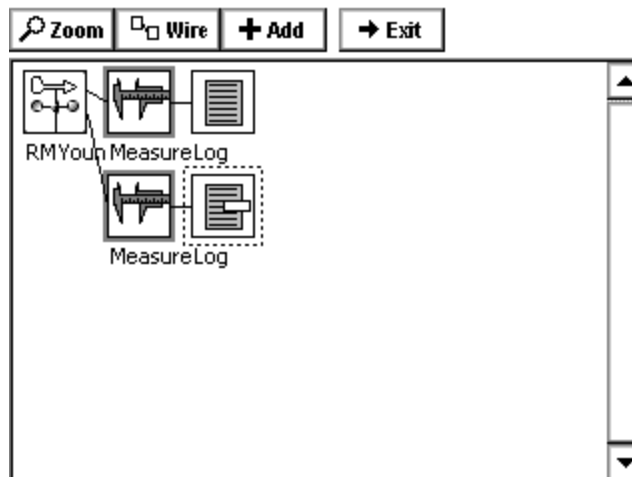

Changing Block Properties

Sensor Block Example

Now that all the setup blocks have been placed and the flow of data established, all that is left to do is to change the properties of each block as desired. The properties window of a block can be brought up by clicking the block and then clicking *Edit Properties*. Doing this for the RMYoung sensor block brings up the following window:

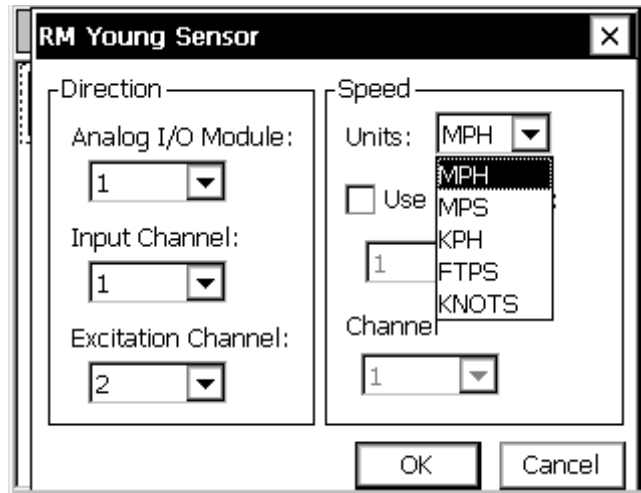

Detailed information on the different fields in this block can be found in Appendix A: Setup Blocks. For now, just change the units to from mph to Knots and click *OK*.

Processing Block Example

Now click the top measure sensor block and select *Edit Properties*:

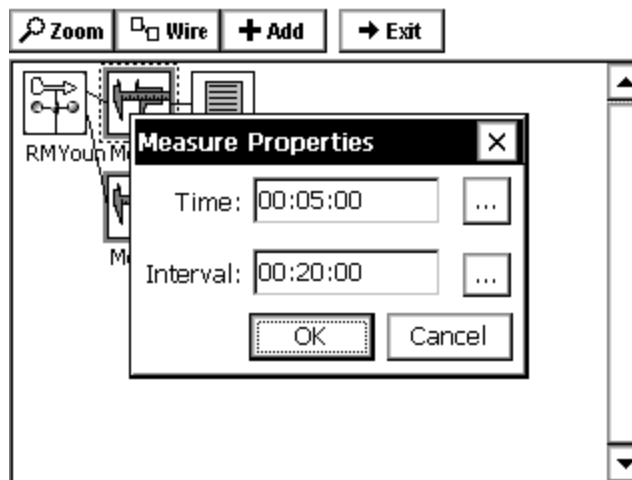

This is where we enter the start time offset and the sampling interval. The measure block is used when samples are desired at a fixed, regular interval. We set up this block to measure wind speed every twenty minutes with a five minute offset from the top of the hour (i.e. at :05:00 :25:00, :45:00 every hour).

Log Block Example

Finally, click the top the log block to view its properties:

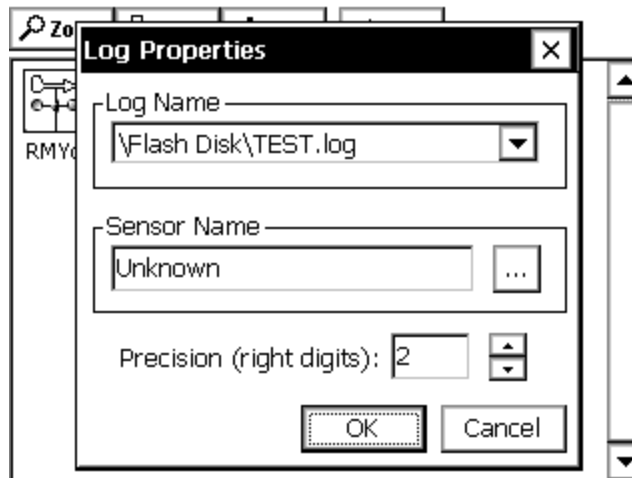

At the top of this properties window is a drop down menu with all the log files that have been created in the system (as well as an option that, when selected, allows you to create a new log file). This drop down box identifies the log to which this setup block will store data.

The default *Sensor Name* can be changed to more easily identify the source of data in the log (this name is used in the Log tab as well as in imported data files). Changing this label is especially important in cases where there are more than one of the same types of sensor.

The *Precision* indicates to what precision the data (wind speed, in our example) will be logged. The value specified should be less than or equal to the sensor's actual precision.

Changing the properties of the other measure block and log block in our setup for sampling and logging wind direction would be done similarly. Full descriptions of purposes and settings for each setup block can be found in Appendix A: Setup Blocks.

Changing the Block Label

The label displayed underneath the block in the setup diagram can be changed by selecting *Rename* from the pop-up menu that appears after clicking the setup block. Use this to help identify specific blocks in the setup.

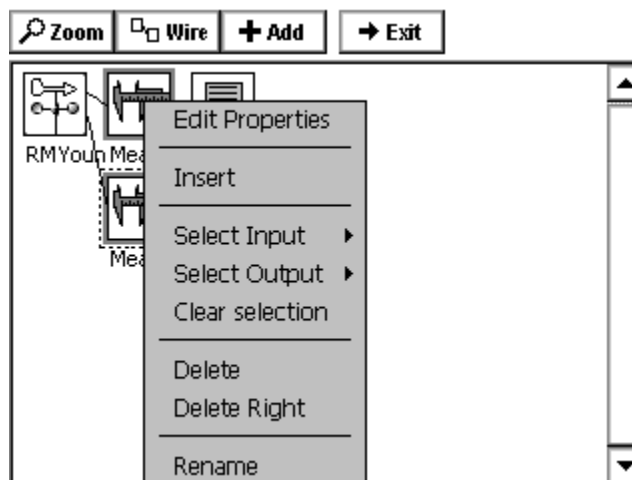

MODIFYING A SETUP DIAGRAM

Wiring and Unwiring

The Xpert will attempt to wire blocks together automatically whenever possible. For example, if the output of a Measure processing block is selected and then a log block added, the system will automatically wire them together. However, sometimes blocks need to be wired or unwired manually.

For a simple example of wiring and unwiring, let's say we want to change the setup we have built so far to: 1) add a solar radiation sensor block and 2) hook its output to the second log block instead of the RMYoung wind direction output.

First, we add a solar radiation sensor using the *Add* button (as explained in the previous section) *without* using the Wizard:

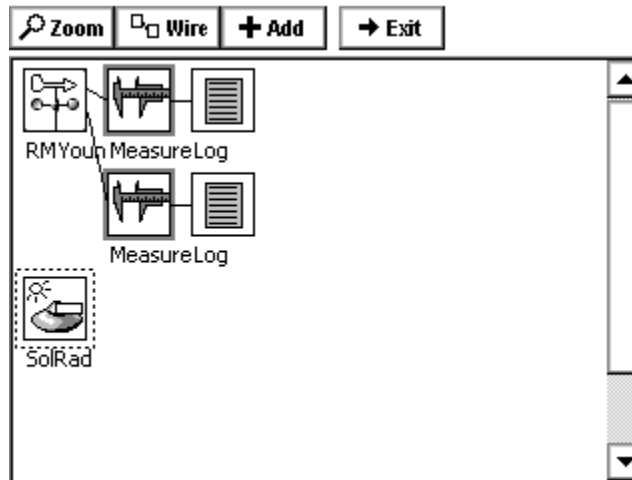

Now we want to unwire the second Measure block. To do this, first click the RMYoung icon and use *Select Output* to select the *Dir(ection)* output. Then click the second Measure block and use *Select Input* to select *Input*. The Setup Diagram will now look like this, with the line connecting the two blocks now in bold:

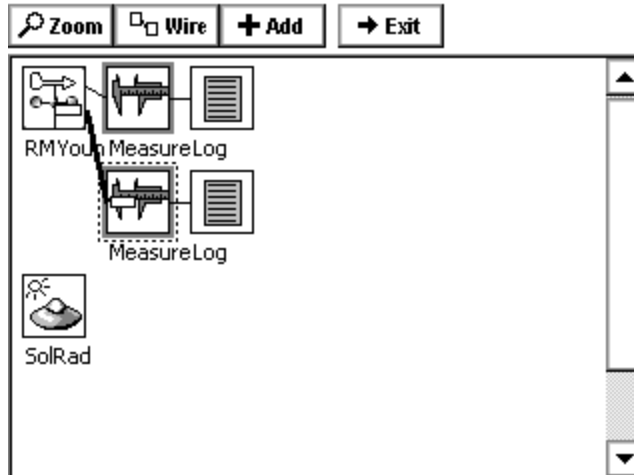

To unhook these two blocks, click the *Wire* button at the top of the screen. The blocks unwired will look like this:

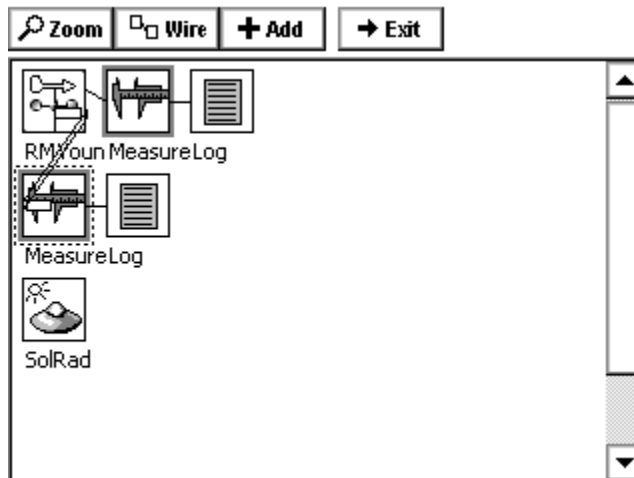

To now hook the measure and log blocks to the new SR sensor we have added, click on the SR icon and use *Select Output* to select its output *SR*:

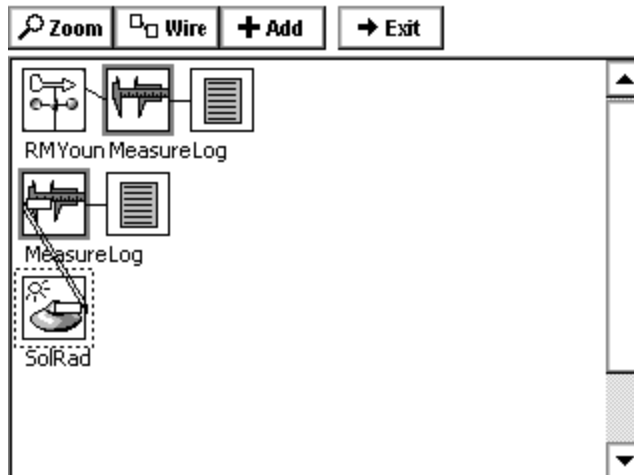

Finally, click the *Wire* button again to get the desired setup:

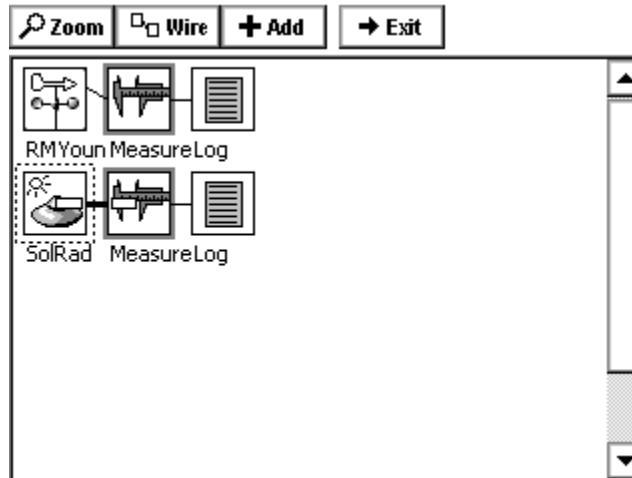

Deleting a Block

To delete a block, select it and then select *Delete* from the menu that appears. This also deletes the wires coming from that block. For example, if we deleted the second Measure block from above, the resulting Setup Diagram would then look like this:

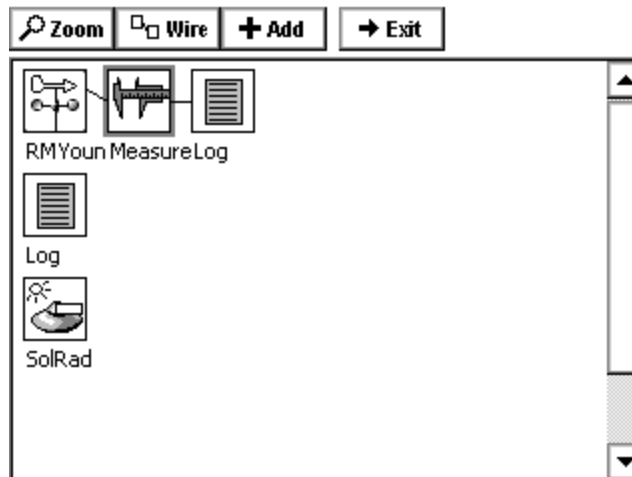

Deleting Multiple Blocks

To delete multiple blocks, click on the left most block, then select the *Delete Right* menu. All blocks to the right of the selected block will be deleted. In the above blocks, clicking RMYoung and selecting *Delete Right* will delete the RMYoung, Measure and Log with one click.

Insert A Block

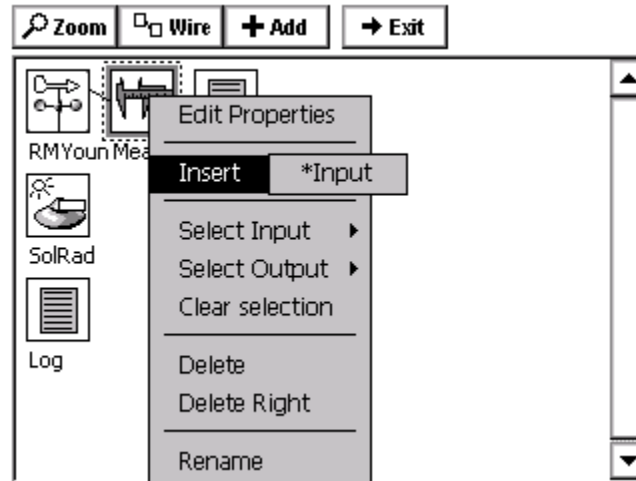

To insert a block into a chain of blocks, simply select a block for the new block to go in front of. So, for the example above, to insert a display block before the measure of the RMYoung, select measure, then insert. Notice the *Input, if a block with multiple inputs is selected, this would show all available inputs, in the case of measure, only one input is available, so click the *Input. The Select Category box will be displayed, for this example, select MISC and then select DISPLAY and click OK.

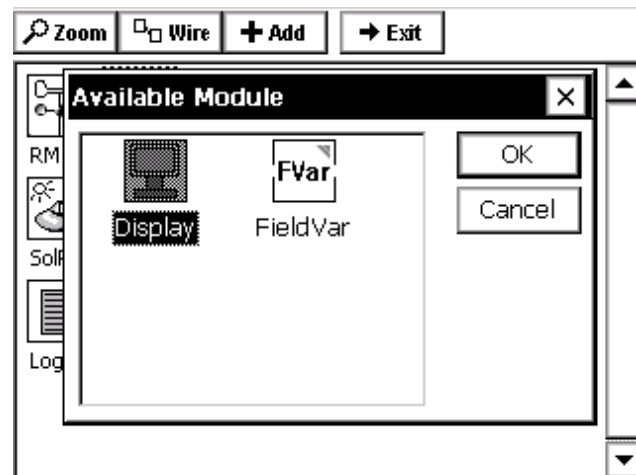

The display is now inserted in front of the measure block.

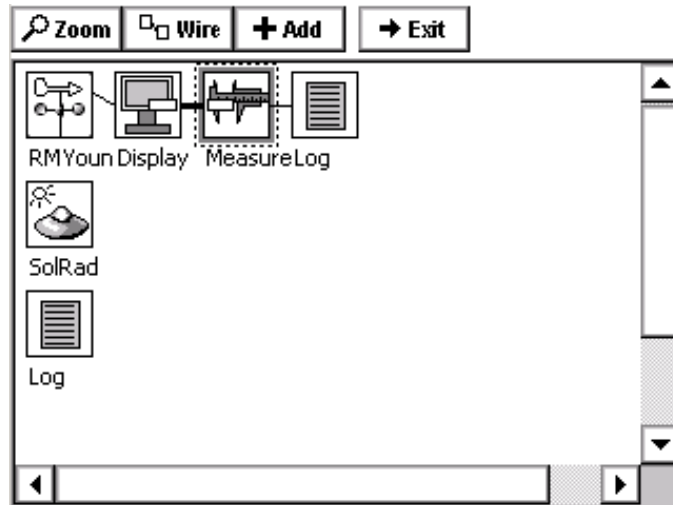

CHAPTER 5: EXAMPLE SETUPS

EZSETUP FOR A STREAM GAUGING STATION

Setting up a stream gauging station with a shaft encoder is simple. The following setup will use a 15-minute measurement interval, log the data and transmit it to a GOES satellite.

Connect all equipment before entering the setup. For this example setup, hook a Satlink to COM 2 and a Quadrature shaft encoder to Digital channels 3-4 (terminal B I/O 3 and I/O 4)

Log into the system using the SETUP account access.

Start by setting the station name. This name will identify the station and allow the setup file name to be unique. Do this from the *MAIN Tab* by clicking the three dots next to *Station Name*: and typing or clicking the letters on the virtual keyboard. LakeTop is used in this example.

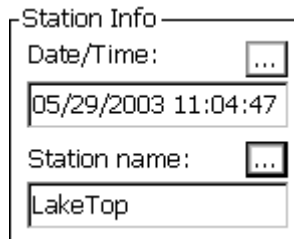

Go to the *Setup Tab*, this is where the rest of the station configuration will take place.

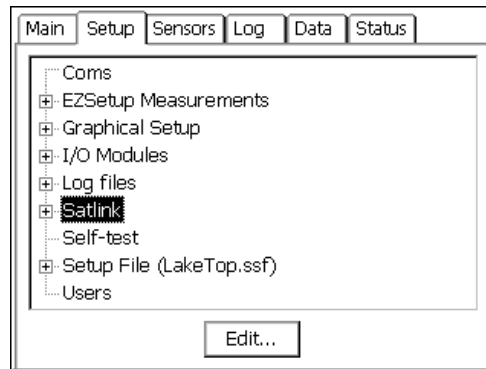

Select the Satlink tree by clicking on it, then, click the *EDIT* button.

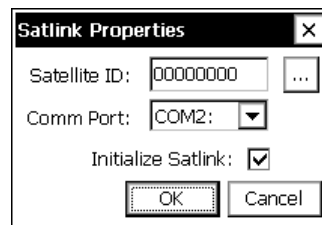

Set the Satellite ID (NESDIS assigned) and COM port Satlink is connected to, and then click *OK*.

If a message saying recording must be turned off appears, click YES, this will stop the system and let the rest of the setup continue. When it asks to restart recording, click NO. Recording doesn't need to start until the entire setup is completed.

Click the plus next to the Satlink tree, then select the Self-Timed branch and click the *EDIT* button. From here, enter all the parameter of the transmission as assigned by NESDIS. For this example, use a 1 hour rate at a 00:00:00 time (offset) and send 8 data values. Also, set the window centering to on and set the window to 15 seconds.

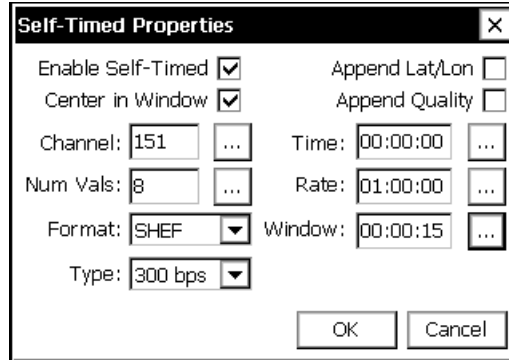

Since this setup is not going to use alarms, no more information is needed for the Satlink setup. If alarms were to be defined, the *RANDOM* tree would be the place to set that information.

Measuring a shaft encoder every 15-minute on a fixed interval is easily accomplished using the new EZSetup tree of the *SETUP Tab*. First, define the measurement interval, then add the sensor and configure it.

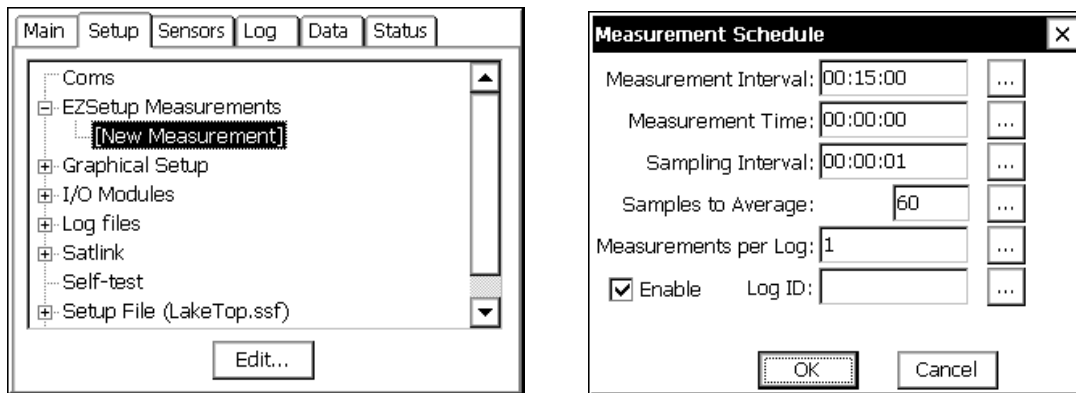

Add the new measurement interval by clicking the plus sign next to EZSetup Measurements, then highlight [New Measurement] and click EDIT.

From here, all parameters for setting up a schedule are shown. For the purpose of this setup, the default values already meet the schedule, so just click OK.

Now that the schedule is defined, a plus sign appears to show that sensors may be added. Click this plus sign to expand the tree, then select [New Sensor] and click EDIT.

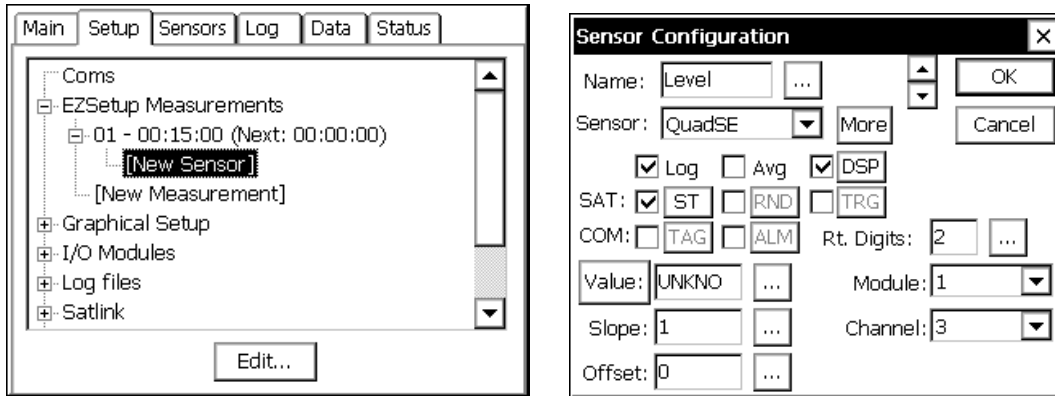

For this example, select a name (Level) select the sensor as a QuadSE, notice the Log and DSP (display on LCD) are already checked, check the ST to send this sensor in a Self Timed transmission, leave default of 2 right digits. Since digital channel one on the built-in 9210 digital module cannot be used with a Quadrature shaft encoder, change the channel to 3 to have a setup that is also 9210 compatible (Note: If an external 8080-0002 were used with the 9210, then channel 1 would be valid).

Click the MORE button to get to the details of the QuadSE properties. See Appendix A to see all the options available for this built-in sensor block. For this setup, leave the defaults.

Click the DSP button to see the properties for the display. It is possible to log a different amount of precision than is displayed on the front panel; the default value used here comes from the Rt. Digits set on the main Sensor Configuration page. For this setup, leave the defaults.

Click the ST button to see the properties for the self-timed transmission. Notice that all the fields are filled in with details previously entered. These details include the Label (From Sensor Configuration), Data Time/Interval (From the EZSetup Measurement schedule), Num Values (From the Self Timed tree under Satlink) and an auto-numbering Sequence (This is the first sensor configured, so it is 1).

Since the transmit format was previously left at the default of SHEF, the Num Values for this sensor are configured here, it is possible to send a different amount of values per sensor. Had BIN-INT (binary interleaved) been selected, this field would display the Num Values set in the Self Timed setup under Satlink tree, but will not allow it to be changed from this properties page. For this setup, leave the defaults.

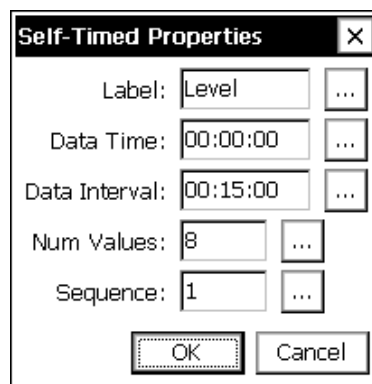

Notice the button labeled [VALUE] and next to it is a box with the letters "UNKNO", this is actually saying "UNKNOWN VALUE" because it has never been measured. Because all the parameters needed to make this measurement have now been configured, press the [VALUE] button to force a live measurement.

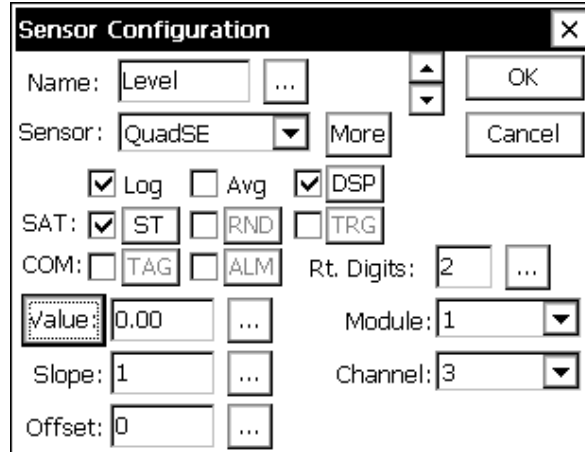

Now, the box is displaying the current value (0.00 in the picture). To set the level to match the actual level (calibration), simply press the three-dot box [...] next to the data, enter the desired reading, and the system now has calculated the offset. Since this example has 0.00 in it, the offset will match what is entered, had the system been running for a while, and had an actual reading, it would have re-calculated the necessary offset automatically. Click OK to save these changes.

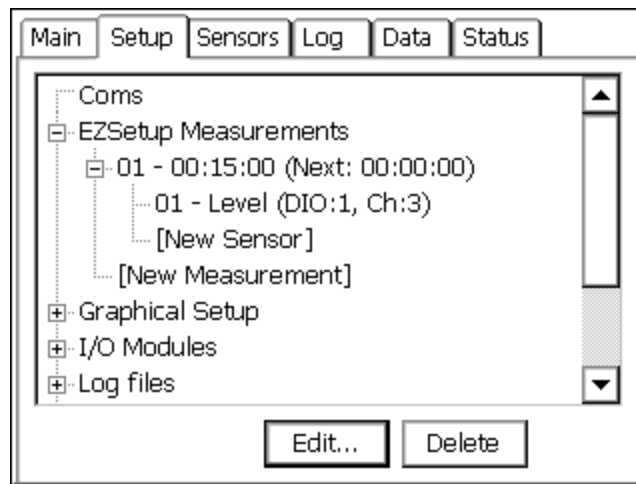

Now the system displays that it has an EZSetup measurement defined, and that a sensor has been placed into that measurement.

Adding more sensors to that measurement is done by selecting the [New Sensor] and repeating the previous steps, selecting the appropriate sensor type, IO module, Channel , etc.

Creating an additional EZSetup measurement, to add hourly averages for example, is done by selecting [New Measurement] and repeating the previous steps, including adding what sensors to measure by this new schedule.

REMEMBER, defining a schedule does no good without defining the sensors below it. So, to add an hourly average of the QuadSE sensor previously setup on the fifteen-minute interval:

Define a new EZSetup measurement, this time setup the Measurement interval to hourly, set the sampling interval to the desired time, and set the number of samples (If one minute interval is used, number of samples could be set to 60 to take samples for the whole hour)

Add a new sensor with the same IO module and channel as previously defined to get the data from the same shaft encoder.

Check the box labeled AVG on the Sensor Configuration screen.

Once the setup is completed, go to the main tab and press START recording.

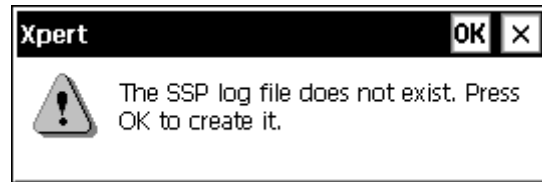

Before leaving the setup tab, a special log file must be created, SSP.log, it is only 'special' because this is where EZSetup places all sensors and this is where communications interfaces look to get 'TAG' data. Had this log file been created already, this warning message would not have appeared. Since the system has detected this log file does not exist it has asked to create one. For this example setup, click OK, and create the default size SSP.LOG file for now. See Chapter 3 - Log Files for more details on this.

Now, that the SSP.log file is created, go to the MAIN tab and press START recording.

That's it! The system is recording data and is going to transmit it on the GOES transmitter.

GRAPHICAL SETUP TO COMPUTE DAILY MIN/MAX

For this example, a 0-5 VDC level sensor, with a 10ft range is used. The last measured value, daily minimum, maximum, time of minimum and time of maximum are displayed on the front LCD and logged. It is a good idea to first draw out in a notebook the desired flow of data, at first simply write down what data needs collected and if it is just logged, or displayed, or both. Then, look through the manual, if an input block exists to make the measurement, use it, if not, find a generic input block (VDC for voltages).

In this example, the data also needs to be processed for daily minimum/maximums. So a special block is needed, this block has already been defined and is provided in the default Xpert library, had it not been included, it would need to be developed, either by Sutron, or by using the software development kit.

Once the measurements have been defined, and the associated blocks needed to do the measurements have been identified, it is time to start building the setup. Below is the result of building the Graphical setup, block-by-block, starting at the left. This was done without the use of the wizard, since multiple outputs and blocks were needed.

Here is the graphical setup:

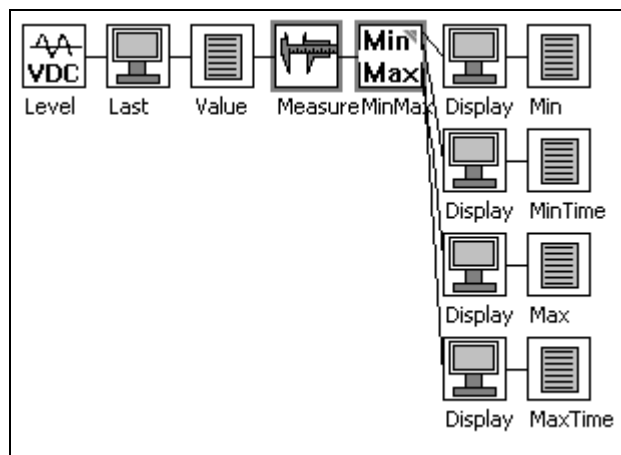

It may look complicated at first, but by looking at it piece by piece it will make sense.

Note that in the graphical setup, data is flowing from left to right. So in the above example:

At the far left is where the data is connected, an analog channel measured by a VDC block.

Next is a display block, this tells the system to display all data that passes through this point (last measured value in this case).

Not only is the data displayed, but it is also logged by placing a log block directly after the display. The log could be placed before the display, but anytime a measurement is forced from the front panel, it would be logged.

Next, is the measure block. This tells the system how often to take readings.

Directly after the measure is the MIN/MAX block. This block also has a schedule that tells the system how often it should compute minimums and maximums (every 24 hours starting at midnight in this example).

The rest of the blocks are wired to the output of the MIN/MAX block. The values are displayed on the LCD and logged. The only output not wired, is the *COUNT* output, this output tells the number of samples used for calculations and was not needed for this setup.

Notice the blocks have been renamed, renaming the blocks will help in maintaining the setup by making it easier to read.

In this example, no satellite transmissions have been defined. Adding transmission parameters is easy. Simply select the output data to transmit by selecting a point (typically a log block) and selecting its output. Then add a self-timed parameter or random trigger block as needed.

Unlike the EZSetup, every block in the Graphical setup must have the parameters defined separately. EZSetup will pass through many of the parameters from one screen to another, because all data is maintained and entered in a specific order. In the Graphical setup, the order of the blocks is not known, and, in some cases, one output may go to several other blocks. For example, in the EZSetup, the label of the sensor is passed into the display parameters for the label of the LCD. In the graphical setup, the label (level) would not make any sense if it were passed into all the blocks that followed it, because additional processing was done to get computed values that are no longer just the level.

Chapter 6: Operation with a PC running XTerm

INTRODUCTION

Sutron has designed the Xpert so that a Windows-based personal computer (PC) running its XTerm program can setup and operate an Xpert without using the front panel. This is a necessity for Xperts that do not have a touch screen display. XTerm supports several connection methods and so can be used to access remote Xperts, e.g., those connected by modem. This section describes how to use XTerm to communicate with an Xpert.

Sutron provides two versions of XTerm. One version is intended for desktop PCs running Microsoft Windows. The other version is intended for PocketPC devices like the HP iPaq and Dell Axim. The two programs perform essentially the same functions, with the biggest difference being that XTerm for the PocketPC displays the Xpert screen rotated 90 degrees. XTerm does this because the aspect ratio of the PocketPC screen is the same as the Xperts except rotated. This ensures the user can see the Xpert screen with maximum resolution.

Installing XTerm

There is no special installation needed for XTerm on a desktop PC. Simply copy it to any folder on your PC.

Always make sure you have the latest version of XTerm, which can be downloaded from Sutron's website. The version of XTerm on your PC can be found by selecting "About XTerm..." in the XTerm System menu, which is accessed by clicking the "X" in the upper left menu bar.

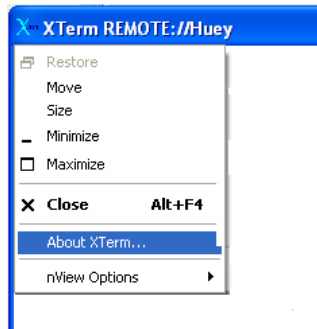

To install XTerm on a PocketPC, run its installation program from a desktop PC that already has ActiveSync 3.1+ installed (this is a Microsoft program that is typically supplied by the vendor of your PocketPC device, and is typically installed as part of the software that comes with the PocketPC. At the time of this writing, ActiveSync may be downloaded from <http://www.microsoft.com/mobile/pocketpc/downloads/activesync35.asp>).

When you start XTerm, the following screen is displayed to allow you to specify and configure the type of communication link that exists between XTerm and Xpert (desktop PC shown left, PocketPC shown right):

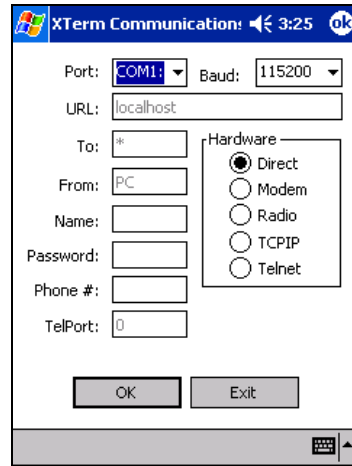
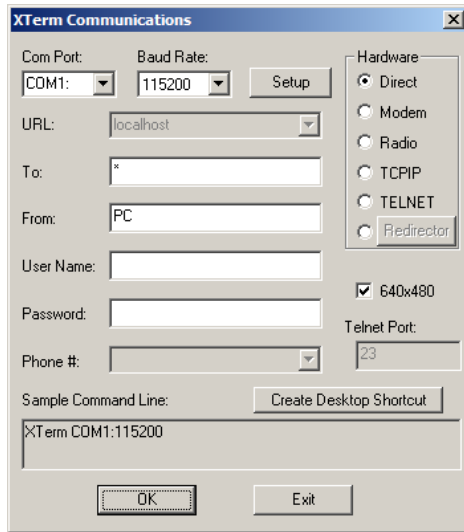

Use the controls on the screen to select the com port, baud rate, type of connection (direct, modem, radio, TCP/IP, Telnet), 640X480 (“big screen” mode when selected) and related values. Setup is an advanced option that allows the SSP timings to be modified to accommodate different types of connections. Select OK and XTerm will begin operation with the type of communications you have selected.

Connection types are as follows:

Direct: Serial cable from Xpert to PC

Modem: Allows XTerm to dial out on a pc modem to a Xpert with modem

Radio: Allows XTerm to control a line of site radio to talk to a Xpert

TCP/IP: Allows XTerm to communicate with a networked Xpert2. If the Xpert2 is connected to a firewall, and TCP/IP access is desired, than the firewall must be configured such that connections on TCP port 52733 will be allowed to the Xpert2. This option may also be used to connect to an Xpert indirectly through another copy of Xterm running on a PC at the IP address specified (Useful to assist other users, since all actions performed on remote pc are viewed at the pc connected to the Xpert/9210).

Telnet: Allows XTerm to communicate with a networked Xpert2 running V3.2 or later of Remote. If the Xpert2 is connected to a firewall, and telnet access is desired, than the firewall must be configured such that connections on TCP port 23 will be allowed to the Xpert2. In general the TCP/IP option is quicker because it has less overhead, but since command line access occurs over telnet port 23, Xterm and command line can share the telnet port, if desired, limiting the number of ports that must be opened in the firewall.

Redirector: Allows XTerm to communicate to a station hosted by the Sutron Redirector service. Pressing the Redirector button will allow to specify the user name and password assigned to you by Sutron for this purpose. You select the station you wish to connect to by entering its name in the URL: box, or you may select it from the list of stations you own by pressing the Detect button.

XTerm for the PocketPC does not show the 640x480 “big screen” option since its screen is too small. The sample command line text area is also missing since the PocketPC does not have a command line.

To configure XTerm to remember selections when run from a desktop PC, press the **Create Desktop Shortcut** button. If you have entered passwords, you will be prompted if you wish to store them in the shortcut. A shortcut that specifies the options you have selected will be placed on the Windows desktop.

Many shortcuts to XTerm may be created, each with a different com port or configuration. Once the shortcut has this additional information, XTerm will not display the communications configuration screen when it starts.

Automatic Detection of Xperts on a Network

When connecting to a networked Xpert using the TCP/IP or Telnet options, a Detect button will appear next to the URL box. Pressing the Detect button will display a list of Xpert stations and various information including IP address, version number of Remote.exe, model, and serial number. Selecting a station and pressing OK will copy that station's IP address in to the URL box. If Xterm is unable to detect a station it may be because an exception has not been created for Xterm in Windows Firewall (requires access to UDP port 52733), or perhaps because the Xpert is running firmware older than 3.2 before this feature was introduced.

The Detect button may also be used in conjunction with the Redirector option to list the stations you own that are hosted by the Sutron Redirector service.

SSP Settings

The Setup button will display the SSP Settings screen containing advanced options for controlling the timing of SSP messages. XTerm is optimized for a 115.2K baud direct connection, and other settings are often necessary for slower or less-reliable connections.

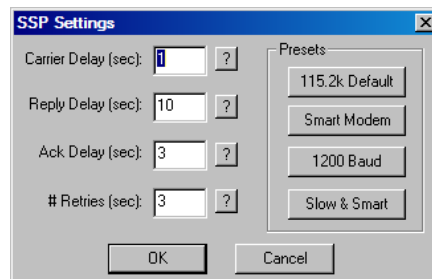

Below is a description of each option and is the same description provided when the corresponding help button (“?”) is pressed:

Carrier Delay (seconds): When the com port is set for ""RADIO"" communications, this is how long to key the transmitter (assert DTR) to warm up the radio before sending data. With Sutron radios typically 1 second or less is needed, but this may need to be increased if hardware repeaters are used in the network, as each hard-repeater in the network needs time to warm-up. Default 1 sec.

Reply Delay (seconds) : This is how long the XTerm will wait for a reply before timing out. This delay includes the time needed for all retries to occur, so it's typically set to the value of AckDelay * (# Retries). Default 10 seconds.

Ack Delay (seconds): This is how long to wait for a response to a message (aka an acknowledgement) before attempting a retry. The default value is 3 seconds, which is suitable for a 115.2K baud direct connection. 10 seconds is recommended for a single hop 1200 baud system connection. It should be increased if lower-baud rates or store and forward repeater hops are necessary.

Retries: More precisely, this is the total number of tries. When an SSP request is made that requires a reply the system will wait for the Ack Delay for the reply. If a reply is not received then one or more retries is performed. # Retries is the total number of attempts to make. The default value is 3. Combined with the default Ack Delay of 3 seconds, this means SSP will send the same message as many as 3 times, with a 3 second delay between each attempt before it will timeout and report a "tx error". All retry messages have the same FLAG SEQUENCE number as the original message. This is used to prevent the same message from being processed twice due to a long network delay.

The preset buttons set the SSP timing according to 4 common scenarios. The 115.2k puts the values back to their defaults. Smart Modem selects a very long (1 minute) ack delay and reply delay since it's expected the smart modem will perform retries, and will normally never fail, but may take a while to send data when line conditions are poor. The "Slow & Smart" settings are similar to the Smart Modem settings but include other enhancements to help Xterm perform over a high latency but reliable connection such as a TCP/IP based cell phone modem. Eliminating retries which would only conflict with the previous message still being sent is one such improvement. "Slow & Smart" may also be selected from the command line with the /SLOW option. 1200 baud selects settings designed to work with lower-baud rates and dumb radio systems.

Redirector Settings

The Redirector button will display the Redirector Connection Settings screen containing options for connecting to a station hosted on the Sutron Redirector service.

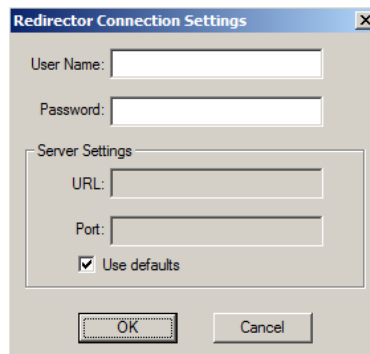

Below is a description of each option:

User Name: The name you were assigned to access the Sutron Redirector service.

Password: The password you were assigned to access the Sutron Redirector service.

URL: The IP address or URL of a custom Redirector service.

Port: The port number of a custom Redirector service.

Use defaults: Check this if you wish to specify custom values for the Redirector service URL or port number – otherwise the settings for the Sutron Redirector service will be used.

Troubleshooting:

If you are unable to access the Redirector service, check to make sure your user name and password were specified correctly. If that doesn't resolve the issue, check with your network administrator that you have rights to access `redirector.sutron.com` on port 80. If your organization blocks non-Web access on port 80, you may also try specifying the URL `redirector.sutron.com` and port 23 under Server Settings.

Preparing the Xpert to work with XTerm

The Xpert comes configured at the factory to communicate with XTerm on its COM1 serial port at 115,200 baud. Connect a standard M-F DB9 cable between the PC and the Xpert. A M-M gender changer and a Null Modem are necessary to connect Xpert to the PocketPC.

The program in the Xpert responsible for communicating with XTerm is *remote.exe*. When the Xpert starts up, it will first check for an *autoexec.bat* file in the *\flash disk* folder. If the file is not there (factory default condition) the system will automatically run *remote.exe* on com1. However, if the file is there, the system will execute the contents of *autoexec.bat*. In this case, *remote.exe* is run only if there is a line in the file to run it.

In the event that a system has an *autoexec.bat* file that does not run *remote.exe* and you want to run it, reset the Xpert and hold a stylus on the touch screen while it starts. When your touch is detected the system will prompt you to see if you desire to bypass the *autoexec.bat*. Select YES and the Xpert will bypass *autoexec.bat* and run *remote.exe* on com1.

Operating XTerm

When XTerm runs and communicates with an Xpert that has user accounts setup, you are required to enter a username and password to gain access. When this happens, simply enter a valid username and password.

When XTerm starts you will see a dialog similar to the one below. The left portion of the desktop window shows the contents of the Xpert display. The entire screen of the PocketPC display shows the Xpert display.

When you click (or tap in the case of the PocketPC) in the Xpert portion of the display, the Xpert will respond as if you had used the touch screen on the Xpert itself. The only exception to this is on the PocketPC: when you tap-and-hold the stylus against the screen for a few seconds, XTerm's main menu is displayed. The options on this menu are the same as those provided by the buttons on the right-hand side of the desktop version.

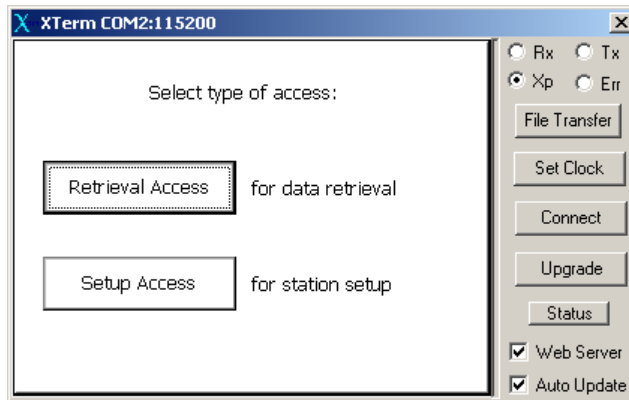

If the screen is blank, or becomes unreadable or garbled, right click in the Xpert display area. This sends a command to the Xpert retrieve again the contents of the display. To do this on the PocketPC, tap and hold the stylus on the screen to access the main menu, and then select “Update Now”.

Note that while you operate Xpert from XTerm, the Xpert’s physical display (if it has one) will also be changing. If someone is looking at the screen while you are operating the Xpert, they will see all that you are doing. Both the touch screen and PC are active at the same time with the same priority so don’t try to work on the Xpert at the same time.

XTerm is very smart when it comes to knowing when and how to update its display. However, the nature of serial communications sometimes causes screen updates to lag slightly, or become garbled. As an example, log-in to the Xpert and select the different tabs of the Xpert display. Notice that it takes time for the Xpert to switch from on tab to another. If you are connected at a baud rate slower than 115,200, the wait for the display to update can be long. If you select a control and don’t see an immediate response, wait a bit and try again. Do not click controls rapidly as this will very likely translate into undesired behavior.

When using the desktop version of XTerm, you can use the desktop’s keyboard as if it were connected to the Xpert. For example, instead of using the Xpert’s virtual keypad (shown below), use your keyboard. The characters typed are sent to the Xpert’s keyboard buffer.

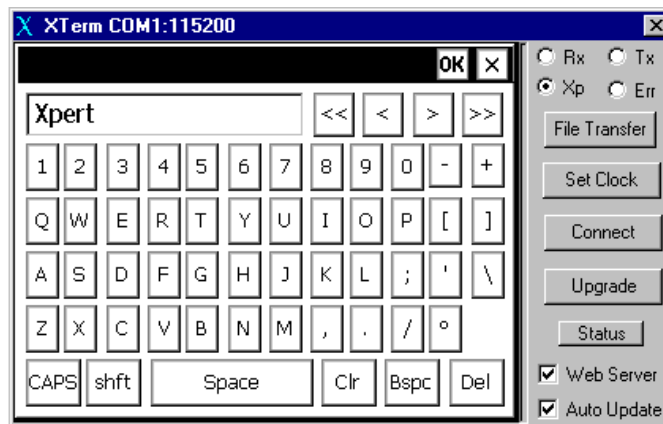

When exporting logs from Xpert using XTerm, XTerm assumes you want to save the exported log on your local PC and so offers a Save-As dialog on the local PC (see below: desktop PC

shown left, PocketPC shown right). If you cancel this dialog, then Xpert prompts for the destination on the Xpert disk the file should be saved.

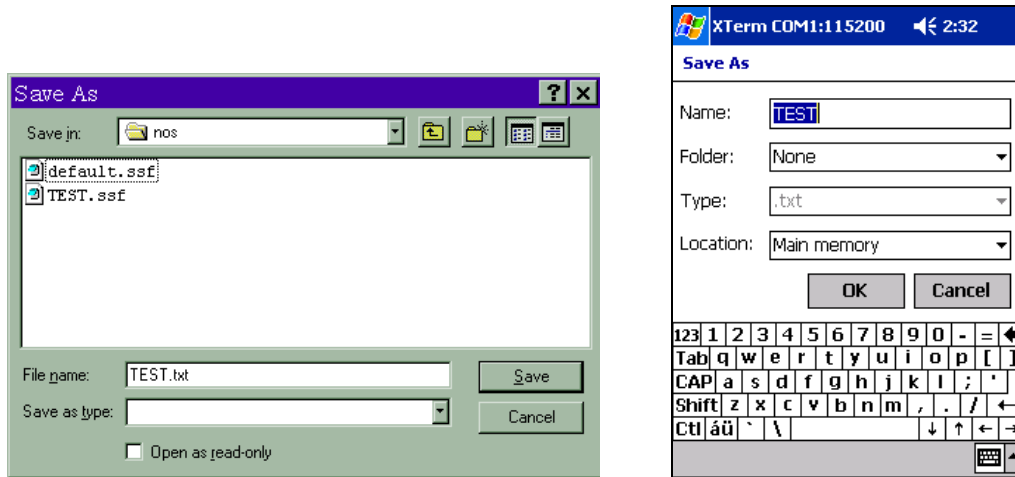

File Transfer

File Transfer is one of the more powerful features of XTerm. Using File Transfer, you can transfer setups and software between the Xpert and your PC. You can also access special virtual files in the Xpert that describe details about the software that is running.

When you select File Transfer, you will see a window similar to the following (desktop PC shown left, PocketPC shown right):

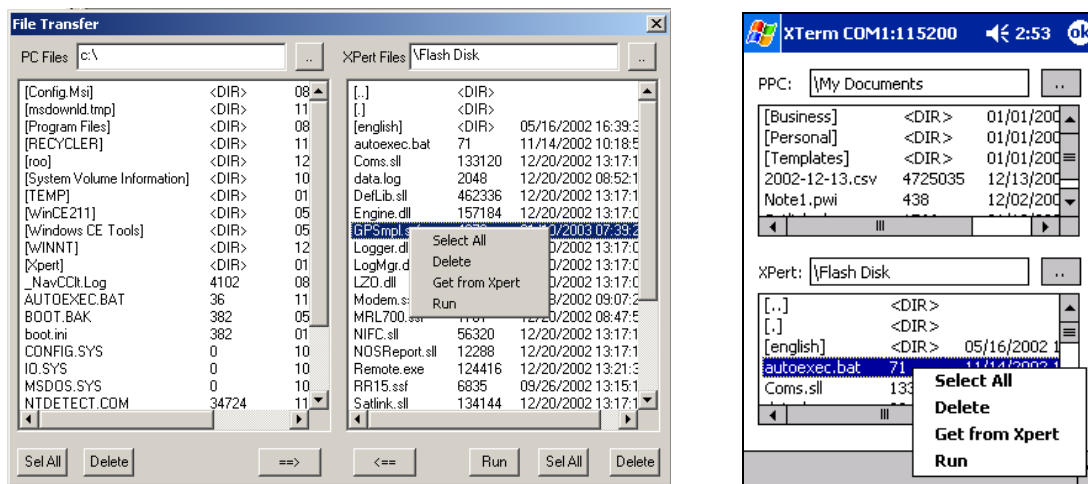

The list on the left (top for PocketPC) shows the files on your PC. The list on the right (bottom for PocketPC) shows the files on the Xpert. You may change the folder that is displayed by simply double clicking on a folder in the window. Selecting the .. control at the top of the window next to the folder name or [..] in the list of files will go to the parent folder.

All the operations you can perform on the file lists can be selected from the file transfer popup menu (shown in the images above). This menu is accessed on the desktop PC by right-clicking in

the list. This menu is accessed on the PocketPC by tapping-and-holding the stylus on the list for a second or two. The desktop PC version also provides buttons to access these operations.

To move a file from the PC to the Xpert, select the file in the PC window and either press the ==> button, or select “Send to Xpert” from the menu. To move a file from the Xpert to the PC, select the file in the Xpert window and either press the <== button, or select “Get from Xpert” from the menu.

On the desktop PC, you can select multiple files by pressing CTRL and then selecting the file with the mouse, or by pressing SHIFT and then selecting the file with the mouse to select a range of files. On the PocketPC, you can select multiple files by pressing and holding the “Action” button while you tap additional files. The “Action” button is typically the largest button on the device below the screen. See your PocketPC documentation for further information.

Use either the *Sel All* button or the “Select All” menu item to select all items in the list.

Use either the *Delete* button or the Delete menu item to delete files on either the PC or Xpert.

Use either the *Run* button or the “Run” menu item to run a program on the Xpert. Note that it is not possible to run a program with command line arguments in this way.

Note that all times displayed on the right side of the file transfer dialog (top, on the Pocket PC), are shown in device-time, which knows nothing about “local” time. All times displayed on the left side (bottom, on the Pocket PC), are shown in PC-time, which reflects a correction for the PC’s local time-zone. This can lead to some confusing behavior when the PC’s local time zone is set to something other than Greenwich Mean Time (GMT), as certainly many are. For example, if you transfer a file from the Xpert to the PC, the file timestamp shown on the PC will be different than what is shown on the Xpert. The key to working through this confusion is to remember the times shown in both cases are each relative to the device on which the file sits (the Xpert or PC).

Process List Folder

The virtual files under the Process List virtual directory give important details on what programs are running in the Xpert. The files are “virtual” in that they do not exist physically as files on the Xpert. The information is organized in this fashion to make it easier to view and transfer for analysis. A sample Process list is shown below. Note that it can take 10 seconds or more for the system to produce the Process List.

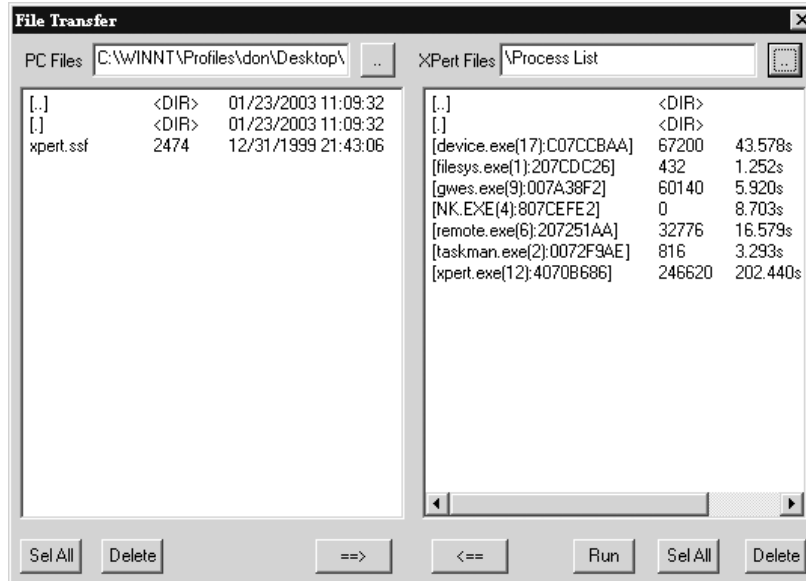

The format of the process information is [name(threads):address] size time, where name is the file name of the process running, threads is the count of threads running, address is the where in memory the program is running, size is the number of bytes used by the program and time is the amount of CPU time in seconds that the program has used.

If you double click on any of the processes, the system will allow you to select threads or heap. A sample thread display is shown below:

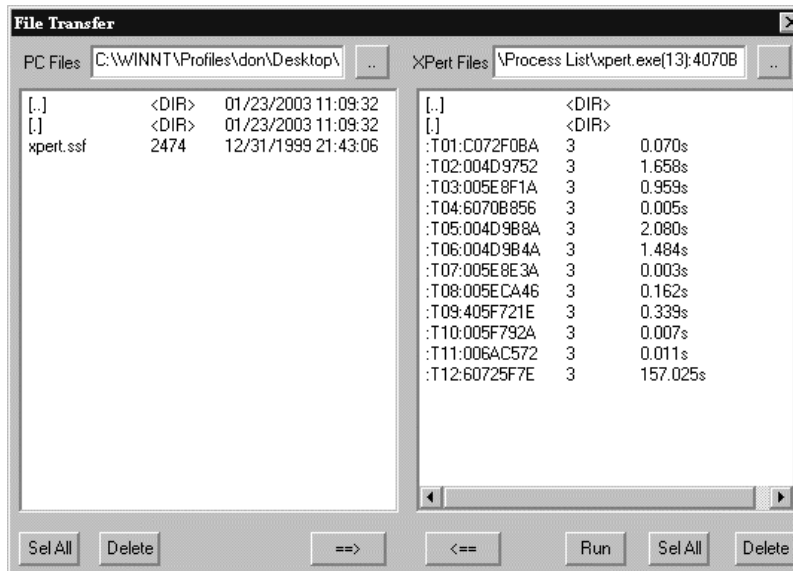

Set Clock

When you press the *Set Clock* button, XTerm prompts, "Would you like to set the Xpert's time to match your PC". If you press YES, the Xpert's clock will be set to match the PC clock. Press NO if you do not wish the time to be set.

Connect

Pressing the *Connect* button brings up the configuration dialog shown and described in the section on installing XTerm. This allows you to change your connection once XTerm has been started.

Upgrade

Pressing the *Upgrade* button brings up a dialog asking for the location of the upgrade file to use to perform a scripted upgrade of the firmware in the 9210. Please see **Appendix B** for more information on how to upgrade.

Web Server

The Web Server check box selects whether or not XTerm should act as a web server proxy for the Xpert. When this box is checked, any web pages on the Xpert will be made available as-if they were actually hosted on your PC. For instance, in Internet Explorer you could enter the URL `http://localhost` to access the Xpert's homepage. If your PC is on a LAN, WAN, or the Internet, then the Xpert's home page can be reached by other users by entering `http://yourIPorURL`.

Regardless of the setting of this box, XTerm always acts as a proxy for other XTerm users on the network. For instance you can test this out by starting a second copy of XTerm with the following command: `"XTerm remote://localhost"`, or from another machine on the network via `"XTerm remote://yourIPorURL"`.

Auto Update

The auto update checkbox causes XTerm to continuously request screen updates. When the checkbox is clear XTerm will conserve the Xpert's power and CPU by only requesting updates for a short time after a key press or a touch.

Station Operations

Right clicking the mouse on the right hand pane (where the "Right click for more options" is displayed) will bring up the Station Operations menu. The menu has options to perform a Startup, Shutdown, or Reboot. A confirmation dialog will be displayed before any of these commands are sent to the station. If the operation cannot be supported due to insufficient access rights or a lack of support in the RTU firmware, a message will be displayed.

Startup

The startup option may be used to start up the main application of the RTU (ex: Xpert.exe). This will also re-configure the Autoexec.bat file on the station if needed.

Shutdown

The shutdown option may be used to initiate a shutdown of main application of the RTU (ex: Xpert.exe). One purpose for shutting down the main application would be if you wanted to transfer a new copy of an SLL to the unit without performing a full upgrade. If you don't allow enough time for the application to fully shutdown, you will receive an error when you try to transfer the file over.

Reboot

The reboot option may be used to gracefully shutdown the unit and reboot it. This is always preferred over just removing power. For instance, the system will startup much quicker if the log files have been closed out normally and don't need to be rescanned.

FireWalls

If you have "Windows Firewall" enabled (like most PCs do these days) you will need to add an "exception" for Xterm.exe in order for it to support all of its networking features. If you use a different type of firewall, you may need to add an explicit access rule for some of the following service ports that are used by Xterm or the Xpert :

<u>SERVICE</u>	<u>PORT</u>	<u>PROTOCOL</u>	<u>HOSTED BY</u>	<u>DESCRIPTION</u>
GUI	52732	TCP	Xpert and Xterm	Used by Xterm to perform log dumps and detect that the Xpert application is running. Xterm also hosts this port in order to support proxy connections. Serial and Telnet connections make use of Xterm's proxy.
REMOTE	52733	TCP	Remote and Xterm	Used by Xterm to access GUI screens and perform file transfers. Xterm also hosts this port in order to support proxy connections. Serial and Telnet connections make use of Xterm's proxy.
AUTO DETECT	52733	UDP	Remote	Used by Xterm to detect Xperts running on the network.
SSP	52734	TCP	Xpert	Used by Remote when it needs to communicate with the Xpert application. This port is used locally by the Xpert and there's no reason to open the port on the PC or in a firewall. Doing so may create a security risk.
TELNET	23	TCP	Remote	Used to support telnet based command line or GUI access (screens and file transfer).
WEB	80	TCP	Xpert	Used by the Xpert's web

<u>SERVICE</u>	<u>PORT</u>	<u>PROTOCOL</u>	HOSTED <u>BY</u>	<u>DESCRIPTION</u>
			and Xterm	server and Xterm's proxy web server.

Configuring the PC modem for use with Xterm

Most PC modems will work with Xterm without any additional configuration needed, simply select the com port the modem is using from the com port drop down box, select the hardware type as modem, and set the baud rate (if needed), and enter the phone number.

If Xterm gives this dialog:



Then check to make sure no other program is using the modem and that the correct com port is selected.

If Xterm gives this dialog:



First check that the phone number has been entered correctly (enter 1 and area code if needed). Then, use Hyperterminal (or other terminal program) and connect to the com port the modem is on. Issue an AT&F command and see OK, if you do not see an OK, then the modem is not working, or is not on that com port. If you get the OK, then issue an AT&FV1&W command to the modem, then close the terminal program and try Xterm again.

Status and Rx, Tx, Xp, Err indicators

XTerm features four status indicators:

Rx: Flashes when a message is received.

Tx: Flashes when a message is sent.

Xp: Is lit when XTerm has detected that the Xpert application is running and that communications necessary for a log dump has occurred.

Err: Flashes when a message is received that has errors. If you see this often, then your serial cable may be suffering from crosstalk (be wary of very thin serial cables designed to be used for a mouse), or your PC may not be capable of keeping up with 115.2K baud serial communication. You could try a slower baud rate (57.6K baud) or a different com port. USB serial ports may have more problems with higher speeds than legacy ports.

The Status button brings up the Communication Status window:

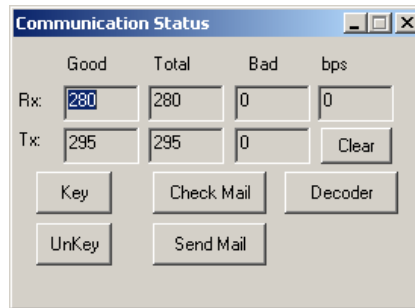

The Status screen displays information about the current session and allows some testing of the SSP (Sutron Standard Protocol) connection:

Rx Good: Number of SSP messages received addressed to your PC;

Rx Total: Total messages received. SSP supports multi-drop (most common with LOS radio systems) where messages can be sent to any station in a network;

Rx Bad: Number of bad SSP messages detected. This would be messages which could not pass a CRC-16 check.

Tx Good: Number of SSP messages transmitted, and acknowledged.

Tx Total: Number SSP messages attempted.

Tx Bad: Number of times an SSP message could not be sent.

Clear: Sets all the statistics to zero.

Bps: The number of bits received and or transmitted per second (computed using a 2-second moving average). If screen updates or file transfers seem sluggish it might be because you're not achieving a very high (bps). This can be caused for numerous reasons including an underpowered PC, communication errors, or just that the Xpert is very busy with processing. The rate achieved will vary depending on what's being performed. For instance, under even the best circumstances, a file transfer to the Xpert will be limited by how fast the Flash Disk can be written.

Key: This keys (powers on) a radio transmitter (asserts DTR and RTS) and can only be used when XTerm is configured to communicate with a LOS Radio.

UnKey: This unkeys a radio transmitter (drops DTR and RTS) and can only be used when XTerm is configured to communicate with a LOS Radio.

Check Mail: This checks to see if you've received a mail message via SSP. When a mail message is received you may hear a beep or the RingOut.Wav file played if it's on your system.

If you wish to test this, you can go to the Setup menu on the Xpert, select Coms (SSP/CL), press Edit, press Test, and click Send Mail.

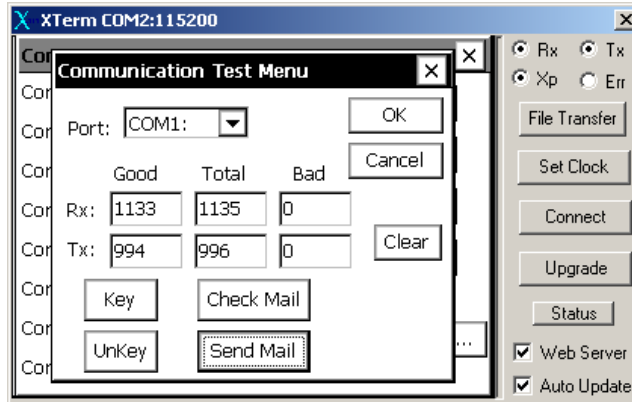

Send Mail: This will prompt for a mail message to send to an Xpert. If successful “Mail Delivered” will be displayed.

Decoder: This is an SSP message decoder that can be helpful for trouble shooting SSP communication problems. The information displayed requires an understanding of the SSP protocol, which is beyond the scope of this manual. However, if you experience some sort of repeatable communication failure, a screen capture of the Decoder window can very helpful to Sutron support staff in figuring out what’s going wrong.

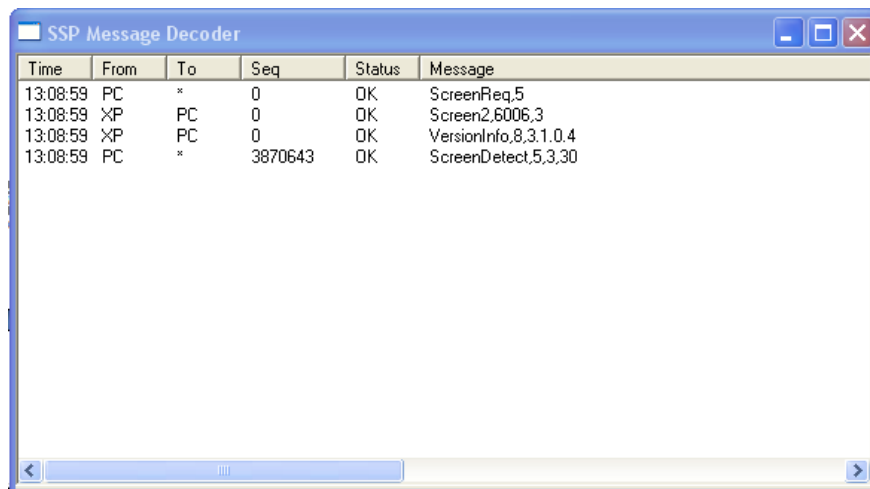

Special Command Line Options

XTerm supports some special options which are not configurable through the CONNECT screen and must be passed on the command line.

/NOHS - disables H/W Handshaking (flow control) allowing Xterm to be used over a 3-line serial port.

/STATS - causes the “Communication Status” screen to be displayed on startup.

/DECODER - causes the “SSP Message Decoder” screen to be displayed on startup.

Chapter 7: Installation

STEPS TO INSTALL AN XPERT

1. Connect Earth Ground to the Earth connection. The earth connection is on the side of the Xpert. **WARNING:** Failure to ground the Xpert can make it susceptible to malfunction or damage by surges and other types of interference.
2. Optional: Wire sensors to the SDI-12 port on the Xpert. You can insert multiple wires into each connection. If the connection is awkward to use, run wires to a separate terminal strip. Note: on the Xpert, you may need to temporarily remove the I2C connector to get better access to the SDI-12 port.
3. Optional: Stack I/O modules together, if multiple modules of the same type are used (i.e. 3 Analog I/O modules) note the serial number of each module before connecting them; you will need this for configuration. Mount as desired. Wire sensors to the terminal strips as needed. Connect I/O modules to the Xpert I2C connection.
4. Optional: Connect SATLINK, SPEECH/MODEM or other communication devices to the desired communications port COM2, COM3 or COM4. The Xpert is wired as DTE so use a straight cable to make the connection. (Note: if your Xpert has COM2, 3 and 4 as Female connections, the ports are still DTE). If you are connecting a modem or other devices to the Xpert, you will need to modify the autoexec.bat to support these devices as explained in the sections that follow.
5. Connect a PC to COM1 using a straight through cable.
6. Connect power to the Xpert. Turn on the power. Observe the Xpert startup.
7. Press Setup Access and log into the Xpert.
8. If you are using I/O modules do the following to make sure the I/O modules are at the desired addresses.
 - a. Select the Setup tab
 - b. Select the + in front of the I/O Module label
 - c. Examine the names of the I/O modules. The names will be AIO and DIO followed by a module number. For each type of module (AIO or DIO) there can be only one number of each type (e.g. there can't be two AIO1 modules). If there are, follow the next step to change. Furthermore, the setup will expect you to connect sensors based on the module number. You have multiple AIO or DIO modules; make sure they each have the proper module number.
 - d. Select each module and press EDIT. Examine the name, serial number and module number.
 - e. If you want to change a module number use the button to enter a new module number.
9. If you have a users.dat file use XTerm to load it into the flash disk. This defines the login accounts for the Xpert. If you don't have a user.dat file you may use the users branch of the Setup tab to set one up. Then save it back to the PC so you can use it at other sites if desired.
10. If you will be using a voice modem, transfer to the Xpert the desired speech files. The speech files take up considerable space on the flash disk. Therefore, you will only want to send to the Xpert the files you expect to need. The speech files are found on the CDROM provided by Sutron with the Xpert. The speech files can also be downloaded from the Sutron web site. On the CDROM, files in the main ENGLISH folder are essential for basic speech operation. Files in the ENGLISH-EXTRA should only be loaded as needed. Use XTerm to transfer the files to the appropriate folder in the \flash disk\speech\ (\English, \Spanish etc.). If the folders

do not exist in the Xpert, use HyperTerminal and issue the MD command to create the desired folders. If you want to create your own speech files, refer to the procedure given in Appendix F.

11. If you have a setup file(s) for the Xpert (default.ssf or anyone.ssf) use XTerm to load them into the flash disk. When the Xpert starts, it will first try to load a setup file that matches the station name. If it doesn't exist, the Xpert will try to load a setup file named default.ssf. If you don't have a setup file you will need to create one. See Chapter 4 for details. After creating the file, save it with the name that matches the station name (*station_name.ssf* or default.ssf if you want it to be used at startup. Copy it to the PC so it can be used at other stations. You may also need to create log files if you are creating your own setup. You typically create log files from the Setup tab. Note: when you load a setup into the Xpert, it will automatically create a log file for you if the setup calls for it.
12. View the setup to make sure it is the desired setup for the station.
13. If you are using a Satlink select the Setup tab, press the + in front of Satlink and do the following:
 - a. Select Satlink and press Edit. Verify the transmission ID is correct. Verify the com port is correct.
 - b. Select Satlink Self-Timed. Verify settings.
 - c. Select Satlink Random. Verify settings.
 - d. Select Self Timed Test
 - e. Verify the sample formatted message.
 - f. Select Status.
 - g. Verify that the status from Satlink is displayed.
 - h. Verify that the GPS is being received.
14. If you have a modem or other device connected to the Xpert, you will need to configure the Coms (SSP/CL) section of the Setup tab.
 - a. Select Coms (SSP/CL) from Control Panel tab, press EDIT.
 - b. Set appropriate com port to your device type (I.E. Select "MODEM" on com 3).
NOTE: SATLINK is configured under Satlink section, so if a Satlink were connected to com2, you would leave com2 as "NONE" in coms section.
 - c. Select the + in front of COMS label.
 - d. Select appropriate com port and press EDIT.
 - e. Configure the device. NOTE: Configure properties will automatically change based on settings from step b (I.E. selecting com3 would show MODEM configuration)
 - f. Once you are done press OK, Xpert will configure each com port.
15. If you have sensors connected to the Xpert you will want to test them to make sure they are operating properly. To test them do the following:
 - a. Turn recording ON. This causes the system to fully activate the I/O modules.
 - b. Select the View Channels tab. You will see a list of all the sensors connected to the system, the channel/module assignments and the last measured value.
 - c. Select each sensor and press the measure button. Verify that the new value displayed is correct.
 - d. If you have SDI-12 sensors, you may also want to press the SDI button. Then issue commands to the SDI-12 sensors to configure them or test their operation.
16. Check to make sure Recording is ON. If you had to go into the setup to make changes, there is a chance that the recording is OFF.

17. Select the Log tab. Select the desired log file and verify that the data is being stored there as desired.
18. Select the Status tab. Look for any errors that may be reported in the status box.
19. Finally, go to the MAIN tab and click LOG OUT.

USING COM PORTS

Overview

The Xpert has four RS232 COM ports (Optionally eight) that can be used for communications devices and serial sensors (with sensor specific setup blocks). The units are configured from the factory to provide +5 volts out on COM3 pin 9, this allows a Sutron Xpert Voice modem to be connected with one serial cable, to communicate and provide power, without the need to open the unit. Pin 9 of all ports are user configurable for Ring In (RI), +5 Vdc out, +12 Vdc out, switched +5Vdc out or switched +12 Vdc out (+12Vdc is input power). Switched options allow the unit to turn on power anytime the com port is opened and turn it off when the com port is closed.

COM1 is a modified DCE (Female), COM2 through COMx are a DTE (Male). Com 1 has pins 1 and 9 as inputs, normal DCE would use these as outputs.

DCE ports are connected to a PC using a M/F DB-9 straight-thru cable. The DTE ports can be wired to modems and Satlink using straight cables.

Pin-out information

COM1 – modified DCE Female

DCE	Signal Name	Direction
1	CD	IN (modified)
2	RD	OUT
3	TX	IN
4	DTR	IN
5	GND	
6	DSR	OUT
7	RTS	IN
8	CTS	OUT
9	RI	IN (modified)

COM2 - 4 (6-9 if installed) – DTE Male

DTE	Signal Name	Direction
1	CD	IN
2	RD	IN
3	TX	OUT

4	DTR	OUT
5	GND	
6	DSR	IN
7	RTS	OUT
8	CTS	IN
9	Set by jumpers to RI, +5V, or +12V	

COM9 on 8080-0000-3B – DTE Male

DTE	Signal Name	Comments
1	NC	
2	RS-485B (Standard nomenclature this would be A)	Idles Low
3	RS-485A (Standard nomenclature this would be B)	Idles High
4	NC	
5	GND	
6	NC	
7	NC	
8	NC	
9	Set by jumpers on J4 to NC, +5V, or +12V	NC is configured by selecting RI.

Note: The Xpert provides a very weak bias to maintain the idle condition. If the connecting device is expecting strong bus biasing, then external biasing resistors can be added. One resistor between the COM9 pin 2 signal and ground with a second resistor between COM9 pin 3 signal and either +5 or +12V. For mild biasing, use 100K resistors. For much stronger biasing, use 10K resistors.

Jumper Settings

The following table gives the jumper settings and their default settings. To change the default settings, open the Xpert and change these jumpers:

	COM1	COM2	COM3	COM4
Configuration Jumper connector	J800	J900	J901	J1000
Default configuration for Pin 9	Ring in	Ring in	+5V Switched	Ring in

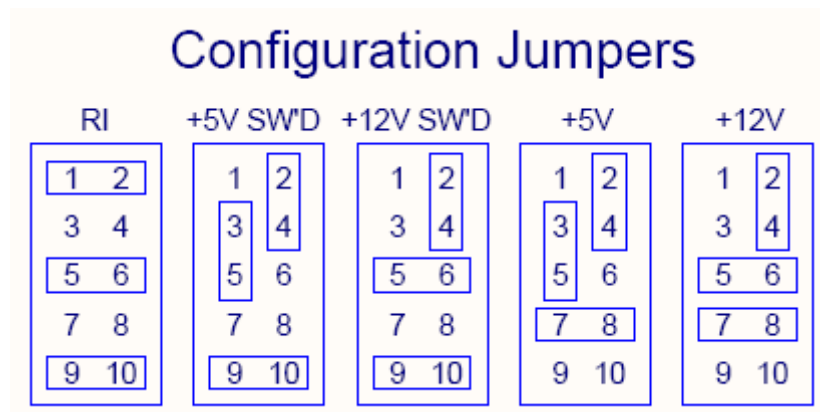

In the switched configuration, power is turned on when the port is opened, and turned off when the port is closed.

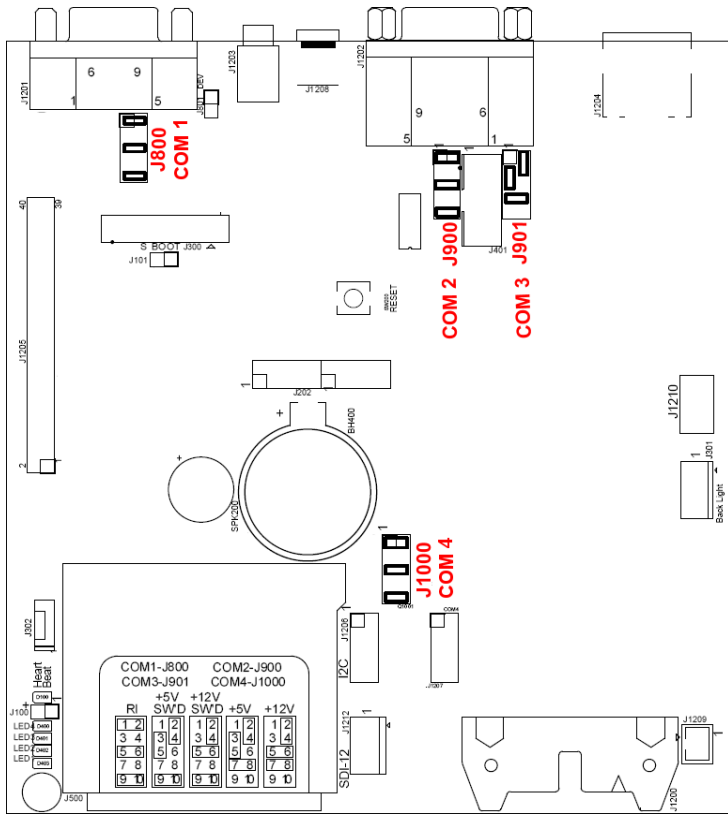

COM 1 – 4
Jumper
Locations

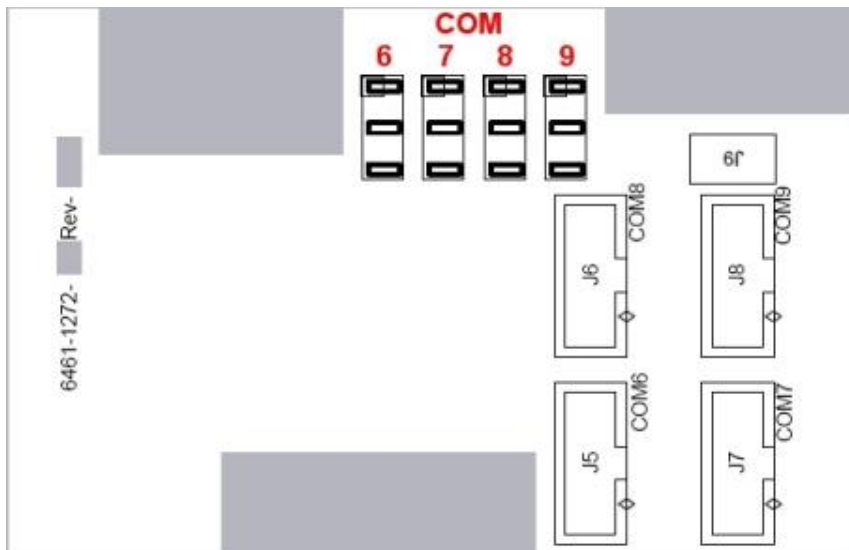

Optional
Com 6-9
Jumper

Maximum Current Draw from Com Port Pin 9

Xpert Com 1 - 4

Each of the pin 9 power outputs is individually fused, and each can provide up to 300mA across the rated temperature range. The fuse is a self-resetting type that will automatically pass power through when the overload/ short circuit has been removed.

Xpert com 5 - 9 (Optional Quad Serial board)

Each of the pin 9 power outputs is individually fused, and each can provide up to 300mA across the rated temperature range. The fuse is a self-resetting type that will automatically pass power through when the overload/ short circuit has been removed.

Switched power settings

The switched power can be set to +5 volts or +12 volts (input power). This switched power is turned on when the com port is opened, and turned off when the com port is closed. If it is desired to provide a switched power, then the software must open the com port when communications need to take place, and leave them enabled until the response is received.

Chapter 8: Maintenance and Troubleshooting

COMMON MAINTENANCE AND TROUBLESHOOTING

Calibrate the Touchscreen

There are two ways to start the touch screen calibration program

Using XTerm , select the program `\windows\touchcal.exe`. Before pressing RUN, hold a stylus on the touch screen in the upper left corner. Then press RUN. As soon as you hear the tones from the Xpert, remove the stylus. The touch screen calibration screen will appear.

Power off the Xpert. Then turn on the power holding a stylus in the upper left corner. As soon as you hear tones from the Xpert remove the stylus. The touch screen calibration screen will appear.

Once the calibration program is running, use the stylus and carefully place it in the center of the + that appears. Hold it for 2 seconds in each spot and then release it. The + will move to another part of the screen. Continue until the prompt: "tap the screen to save settings" appears. If you don't want to save the settings, wait for the screen to timeout and then start the calibration program again.

Skip the autoexec.bat

If a unit does not appear to be running the Xpert app (blank screen) or communicating with a PC, then it is possible that the autoexec.bat file has become corrupted or modified incorrectly. Follow these steps to skip the autoexec.bat file:

For an Xpert with a LCD display, hold the stylus in the center of the touch screen, and then apply power. Leave the stylus on the touch screen until you see a prompt to skip autoexec.bat, and then press YES.

For a non-display Xpert, connect a PC running a terminal program to COM1 and apply power to the unit. After the terminal displays "Press Ctrl-C to skip execution of Autoexec.bat:", press CTRL key and C <CTRL-C>, hold until message displays "Bypassing \flash disk\Autoexec.bat..."

Once the unit has finished booting, the autoexec.bat file may be retrieved from the unit, modified, and then transferred back onto the unit. Re-apply power and let the unit execute the new autoexec.bat file to verify it is fixed.

Unit missing functionality

After upgrading a unit, if the unit appears to be missing some functionality (missing tabs/missing menu items/etc.), it is possible the unit detected an incorrect version of dll/sll and did not load it.

If this happens, a warning message is shown on boot-up and a warning message will be placed into the system log indicating what version was found and what is expected. If this happens, simply copy the correct version of dll/sll onto the flash disk and re-boot the unit.

Xterm has a White screen or Black Screen

When using Xterm to talk with a Xpert, if the screen area does not show the login prompt or menus:

Black screen- This indicates the unit is not communicating. Check that the unit has power and that the serial cable is connected. Also check that the correct com port and baud rates have been selected.

White screen- This indicates that Xterm is communicating with the Xpert, but no program is running. First try right-clicking into the screen area to ensure the screen is updated. Check that the unit has an autoexec.bat by using file transfer, if it doesn't, send one to the unit (either create one following APPENDIX F or get it from the web site) and reboot it. If it does have one, transfer it to the pc and edit it to make sure it has the line \Flash Disk\Xpert.exe in it. If the unit has the autoexec.bat and it has the line to run the xpert.exe in it, then close xterm, run a terminal program (@ 115200,8,N,1) and reboot the Xpert. You should see the very last line of bootup information showing:

Launch complete.

If you do not see this, or get any other errors, contact customer service for further assistance.

Adjust the contrast

On power up, the Xpert starts with the contrast at a fixed value. You may change the contrast either at the login screen or at the main tab of the Xpert. When the login screen is displayed, tapping the touch screen in the upper right corner will darken the contrast while tapping the touch screen in the lower right corner will lighten the contrast. Wait at least 2 seconds between each tap to give the display a chance to adjust to the new contrast setting.

At the main tab of the Xpert you will find a display of the contrast voltage and two buttons to press to adjust the contrast. Pressing <= will lighten the contrast and pressing => will darken it. The corresponding voltage will also be displayed.

Replace the Internal Battery every 5 years

DISCONNECT POWER before opening the unit.

The Xpert has an internal lithium battery to keep the clock running when power is removed. This battery should be replaced every 5 years as a preventative measure. Typically, on a unit that is sitting on the shelf with no power applied, the battery will last for 9 years. The 5 year recommendation is intended to provide a margin for the worst case situations. The battery is a 3 Volt, BR2330 type coin cell.

Upon power-up, the RTC date and time validity are checked. If determined to be invalid, the unit will set the date to 1/1/1984. A unit that sets its date to 1984 needs to have its internal battery checked and most likely replaced.

To replace the battery, remove power from the unit, remove the 8 screws holding the bottom of the case to the top, slide the bottom out of the top, locate the battery, use a small screwdriver to help lift the battery out of the holder, slide the new battery into the holder.

Cleaning Instructions

The touch screen can be cleaned with common mild window cleaning products. To clean the Xpert touch screen, spray the cleaner on a clean cloth and then wipe the touch screen. Do not spray directly on the touch screen as the cleaner may run down into the Xpert. You do not need to remove the power from the Xpert to clean the touch screen.

The Xpert case can be cleaned using common mild window cleaning products. Do not spray the cleaner directly on the Xpert. Instead, spray the cleaner on to a clean cloth and then wipe the case clean. Never spray cleaner directly on the terminal strips or on the wiring.

Fuses

There are no replaceable fuses in the Xpert. The Xpert does use a number of self-resetting fuses to help protect the unit from damage when lines coming from the Xpert are shorted. You may optionally use a fuse in the cable you connect to provide the Xpert with power. This fuse should be rated for at least 2 amps.

Appendix A: Setup Blocks

INTRODUCTION

The power of the Xpert is in its setup blocks. These blocks do the work of measuring, processing, logging and telemetry. Sutron will regularly develop new setup blocks to provide an expanding support for new sensors and updated processing. Customers will also be able to create setup blocks using optional software available from Sutron.

Following is a list of setup blocks that are provided with the system. The blocks are grouped as sensor blocks, processing blocks, log blocks, telemetry blocks, control blocks, and miscellaneous blocks.

Whenever connections to ground or to an excitation are shown in the connection drawings for analog measurements, these connections are expected to be made to the appropriate points on the module performing the analog measurement, not to a similarly named pin on a different module.

Note: Analog connections are shown for the 8080-0003 AIO module. The 8080-0003 has the capability of providing excitation out of any of the analog channels. The 8080-0003 module also has built in current sensing resistors to eliminate the need for external resistors in most configurations. This differs from the 8080-0007 AIO module which has a fixed Vref terminal and no built in current sensing resistors. If using the 8080-0007 AIO instead of the 8080-0003 AIO, then please refer to [Example Configurations Using the 8080-0007 Analog I/O Module](#) section for the appropriate wiring connections.

SENSOR BLOCKS



Air Temperature Sensor (AirTemp)

Inputs

<none>

Outputs

AirTemp

Wiring

Connect the thermistor as shown below. Set the excitation channel and the measurement channel the same.

NOTE: DO NOT USE CHANNELS ABOVE 8 FOR EXCITATION.



Wiring Diagram for a **linear** sensor connected to a 8080-0003 module, excitation channel and measurement channel not the same:

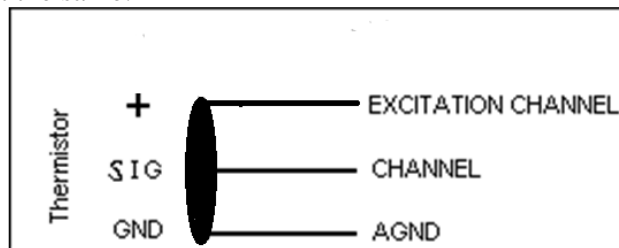

LINEAR

Description

This block supports temperature sensors based on the YSI44006, YSI44032 and YSI44036 thermistors. The AirTemp block makes a resistance measurement of the temperature and then converts the resistance to temperature. Choose the Analog I/O Module number, the analog channel (input) the sensor is hooked to, and the units this block should output the temperature in.

The following table shows the thermistor used by the different Sutron sensors:

Sutron Sensor	Thermistor
5600-0010	Linear*
5600-0011 **	44032
5600-0020	Linear*
5600-0025 **	44036
5600-0030 **	44036

* When this air temp block is used with linear sensors, a double voltage measurement is made. If desired, a linear sensor can also be measured by the voltage block and appropriate values for slope and offset

** The 5600-0011, 5600-0025, and 5600-0030 thermistor assemblies come with a sense resistor to connect from the assembly to Vref. This sense resistor is not utilized when connecting the thermistor assembly to an 8080-0003 AIO module.

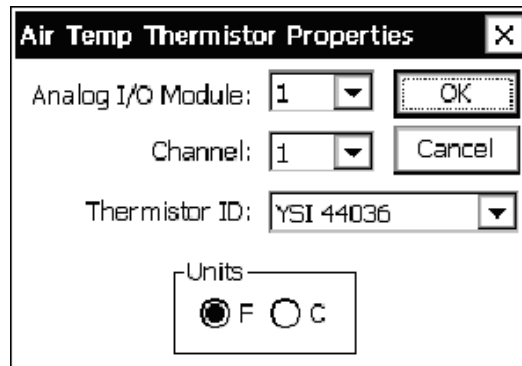

Configuration diagram for linear sensor using Xpert (Slope and offset are preset based on Thermistor ID)

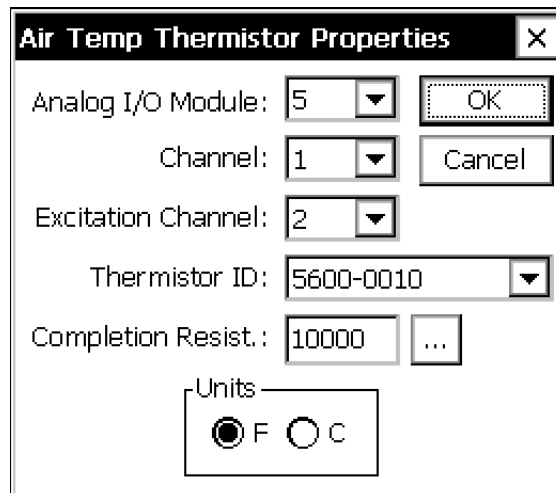



Air Temperature/Relative Humidity (AT/RH)

Inputs

<none>

Outputs

TempOut

HumidOut

Wiring

Wire each output to a separate analog channel

Power the sensor off of the Battery of SW12 as selected in the setup.

Description

This block supports the Sutron air temperature/relative humidity sensors 5600-0311, -12, -13, -14 the Rotronic HygroClip S3, and the Vaisala HMP45, HMP155G (“active” model supporting -40 - +60), and HMP155J (“active” model supporting -80 - +60). Select the proper Analog I/O module, temperature channel, humidity channel, and temperature units. If the sensor is hooked up to a constant power source (that is, either to the battery directly or the Batt terminal of the module) select *Batt* for power. If the sensor is hooked to the SwBatt terminal of the module so as to not draw current unless the sensor is begin sampled, select *SW Batt* for power. Specify the number of seconds the sensor should be powered prior to measurement in Warmup (s). To keep the block from ever outputting greater than 100 for humidity (corresponding to 100% relative humidity) check the box next to *Limit Humidity*.

AT/RH 5600 Properties

AIO Module: 1 Power: Batt

Temp Chan: 1 Type: 5600-0311

Hum Chan: 2 Warmup (s): 3

Limit RH to 100%

Temp Units
 Celsius Fahrenheit

OK Cancel



Analog (ADC)

Inputs

<none>

Outputs

AIOData

Wiring

This section discusses the many different ways to use the ADC block from a wiring perspective.

Excitation

Many sensors are resistive or ratiometric in nature and need an excitation voltage. A programmable excitation is available that is turned on during the measurement by checking the “Excitation On” box.

Any of the 6 analog channels can also provide the excitation output. Select which channel to use as well as the appropriate excitation voltage. When needed, the Xpert will measure the excitation output voltage.

NOTE: DO NOT USE CHANNELS ABOVE 8 FOR EXCITATION.

Voltage – Single Ended

Sensor Vout connect to any analog channel CH1..CH6

Voltage – Differential

Sensor V+, V- connect to any pair of analog Channels CH1/CH2, CH3/CH4 or CH5/CH6. The lower channel of each pair is for the + connection on the Xpert and should be the channel that is measured.

Current 4-20 ma

Connect the sensor to Vbat or +12 SW. Connect the other end of the sensor to the selected analog channel CH1..CH6.

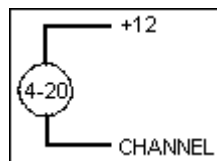

DC Resistance – General Information

Resistance measurements always require excitation on and a selection for the excitation voltage. The excitation channel may be different from the measurement channel for 3 and 4 wire measurements.

DC Resistance – 2 wire

Set excitation channel to match input channel.

Connect one end of the resistor to the selected analog channel CH1..CHxx.
Connect the other end of the resistor to GND

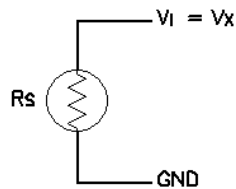

DC Resistance – 3 wire

Set excitation channel to be different from input channel.
Connect one end of the resistor to excitation channel and input channel using separate wires.
Connect the other end of the resistor to GND

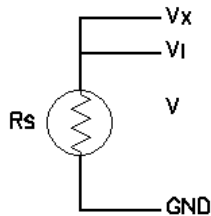

DC Resistance – 4 wire

Set excitation channel to be different from input channel. Select differential measurement.
Connect one end of the resistor to excitation channel and input channel (CH1, CH3 or CH5) using separate wires.
Connect the other end of the resistor to an input channel (CH2, CH4, or CH6) and GND using separate wires.
Connect the sensor to channels 1,2; 3,4; etc. as selected for a differential measurement. Connect the sensor as shown below.

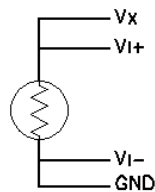

AC Resistance – 2 wire

Set excitation channel to match input channel.
See connection information for DC Resistance.

AC Resistance – 3 wire

Set excitation channel to be different from input channel.

See connection information for DC Resistance.

AC Resistance – 4 wire

Set excitation channel to be different from input channel.

Select differential measurement.

See connection information for DC Resistance.

Thermistor – 2 wire

Set excitation channel to match input channel.

Connect the thermistor (or any resistance device) as shown below. The excitation channel is V_x . The input channel is V_i .

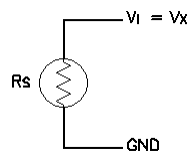

Thermistor – 3 wire

Connect the thermistor (or any resistance device) as follows. The excitation channel is V_x . The input channel is V_i .

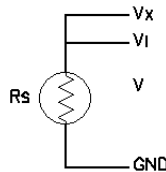

Thermistor – 4 wire

Select differential measurement, set the excitation channel to be different from the input channel.

Connect one end of the resistor to excitation channel and input channel (CH1, CH3 or CH5) using separate wires.

Connect the other end of the resistor to an input channel (CH2, CH4, or CH6) and GND using separate wires.

Connect the sensor to channels 1,2; 3,4; etc. as selected for a differential measurement. Connect the sensor as shown below.

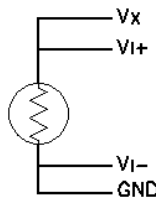

DoubleVolts

DoubleVolts is intended for making ratiometric measurements for a potentiometer and other similar ratiometric devices. The output value is the ratio of V_i/V_x . Since both V_i and V_x are measured, the measurement is called DoubleVolts.

Set excitation channel to be different from input channel.

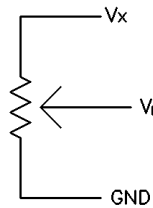

Description

The Analog block is a general-purpose setup block for making voltage, current, resistance, or thermistor resistance measurements from an Analog I/O Module. One analog output and/or one analog input can be setup with each Analog block. Reading the information on the Analog I/O Module in Appendix C: I/O Modules will help with the understanding of this powerful block.

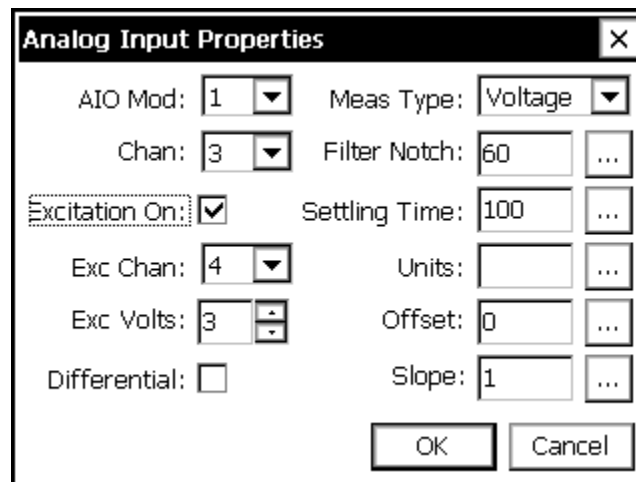

The block scales the outputs according to the values of *Slope* and *Offset* using the equation $\text{output} = \text{reading} * \text{slope} + \text{offset}$.

The user can change the units for all the outputs by changing the *Units* field to the desired value.

The block supports calibration from the Sensors page. For the calibration, the user will enter the current value sensor. The system will then adjust the offset so the desired value is obtained.

To setup a sensor with the Analog block, first select the Analog I/O module to use. Then select what is to be measured under *Measurement*:

Voltage: This is for performing standard analog voltage measurements, similar to what could be done with the VoltMeter block. It requires one input channel for a single-ended measurement or an input channel pair for a differential measurement.

Current (4-20mA): This is for making current measurements in the range of 0 to 20ma. It requires one input channel for a single-ended measurement or an input channel pair for a differential measurement. The dialog changes slightly when this measurement type is selected:

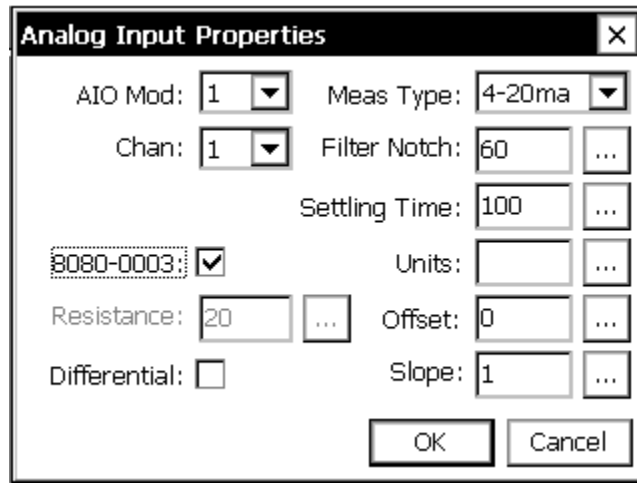

When measuring using an Xpert AIO module, make sure “8080-0003” is checked (this option is typically only used on the Xlite/9210).

DC resistance: To measure resistance, set-up an excitation channel and hook the device or medium to be measured between this channel and ground. The I/O module will do a voltage over current calculation to determine the resistance. The excitation voltage should be set to a value appropriate to the approximate resistance being measured. DC resistance uses a built-in precision 20 ohm resistor as the reference for the resistance measurement.

AC resistance: If this is selected, the I/O module will take two measurements for every measurement value the block outputs. The first measurement is done using the voltage specified by the excitation voltage and the second with this voltage negated. This can be used in cases where applying a DC excitation voltage would causes undesirable changes to the medium being measured.

Thermistor: This is a specialized resistance measurement geared for thermistors. A 10k internal resistor is used instead of the standard and the excitation channel voltage is overridden to be 5V. The output is the thermistor’s resistance. If the desired output is temperature, then please review the Air Temperature block to see if it directly supports the thermistor to be measured.

Volts HiGain: When you select the “Volts HiGain” measurement type, a voltage measurement is made using hi gain. The maximum input voltage is 312mV when measuring using the 8080-0003 Analog IO module, and is 78mV when measuring using the 8080-0007 Analog IO module.

Volts x128: When you select the “Volts x128” measurement type, a voltage measurement is made using very high gain. The maximum input voltage is 39mV when measuring using the 8080-0003 Analog IO module, and is 19mV when measuring using the 8080-0007 Analog IO module.

Differential measurements can be made for each of the above *Measurement* choices. If you specify a differential measurement, be sure to select only channels 1, 3 or 5

To enable an excitation channel click *Excitation On* and then select the channel number to use and the voltage level to output. Xpert can generate excitation voltages on any channel (1-6).

Filter notch: This is a built in noise filter, the defaults of 60 should work for many measurements. If AC line noise becomes an issue, lowering this value will help reduce the noise. Lowering this value will also make measurements take longer.

Settling Time: This is the amount of time in milliseconds to leave the A/D (circuitry, switched 12 volts and VREF to sensors) powered before taking measurements. Sensors requiring a longer settling time, also called warm-up time, should have this value increased. Range for using the switched 12 volts is 0 to 30000 (30 seconds) for external AIO module.

BP Barometric Pressure (BP)

Inputs

<none>

Outputs

BP

Temp

Wiring

Connect the sensor to the SDI-12 port.

Description

This block supports the Sutron Accubar Barometer, part #5600-0120. This is an SDI-12 sensor. Select the pressure units, the SDI-12 address of the sensor and the averaging time (averaging time is used to increase the measurement accuracy by lengthening the sampling time). This block can also return temperature by clicking the box next to *Enable Temperature* and selecting the desired temperature units.

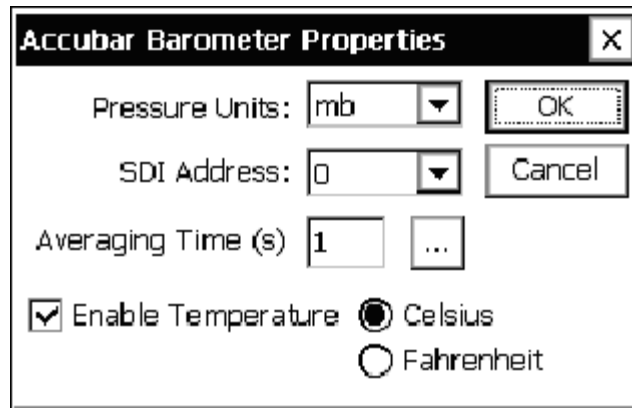

BEI Absolute Encoder (BEIEnc)

Inputs

<none>

Outputs

Output

Wiring

Connect the sensor to a RS232 port as follows (wiring is shown for the 6461-1239 protection board:

Color	Name	Pin (6461-1239)
Red	+12	6
White	RXD	2
Blue	TXD	3
Green	DTR	1
BLK/Brown	GND	5

Note: (jumper J3 on the 6461-1239 to DTR)

Also make sure to configure Xpert for +12 on pin 9 of the DB9.

Also note that the encoder must be set to 4800, N, 8, 1.

Description

This block supports the BEI Absolute shaft encoder. This encoder connects to any of the Xpert RS232 ports. See the section *Wiring* for the details of the connections. There are three user set properties for the BEI Encoder: Com Port, Range and Offset. Use Com Port to specify which RS232 port the encoder is connected to. **NOTE:** Leave the settings in the SETUP TAB/ COMS (SSP/CL) set to none, as this block will not be able to use the com port if Coms (SSP/CL) is already using it.

Range and Offset are used to scale the reading to the proper units. The equation used is:

$$\text{Output} = \text{Reading} * \text{Range} + \text{Offset}$$

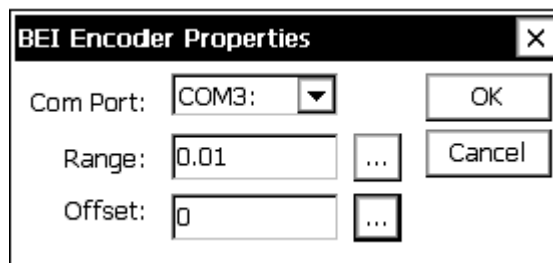

Binary Input (BinIn)

Inputs

<none>

Outputs

BinOut

Wiring

Signal: Any digital input channel

Ground: Any available ground

Description

This is a general-purpose block for configuring a binary input hooked to a Digital I/O module. The *Channel* is one of the eight inputs available on the module (see Appendix C: I/O Modules).

A processing block such as Measure or Average is used to request data of this block, unless *Event* is checked. With *Event* checked, the output will update on change of state. Use “Edge” to determine which edge of the state change to trigger (Rising = Low → High, Falling = High → Low, Both = either direction).

The Filter parameter can be used to eliminate false state transition detections due to noise. The Filter value should be a number between 0 and 255. The higher the number, the longer the new state change must exist for the change to be seen by the digital I/O module. Each increment of the filter value represents about 0.5ms of time.

If this block is used in an EZSetup measurement with the *Event* checked, this will force ALL measurements to occur when an *Event* occurs. So, for example, if you had an EZSetup measurement schedule with the BinIn block and a sdi-12 sensor, every time the BinIn detected a change of state, the SDI-12 sensor would also be measured.

If *Invert* is checked, the output from this block will be the inverted value of what is seen at the channel (e.g., if the input is grounded, a binary 1 is output instead of a binary 0).

Input states are:

0V = binary 0

>2.5V = binary 1

Binary Input Properties [X]

Digital I/O Module: 1 [v] [OK]

Channel: 2 [v] [Cancel]

Invert Input

Event

Edge: Both [v]

Filter value: 0 [] [...]



Binary Input – All Channels (BinInAllChan)

Inputs

<none>

Outputs

DIOData

Wiring

Signal: wire to all input channels defined in Bit Selection. Channels 1 – 6 have 100k internal pull-up resistors. Therefore, if open collector outputs are connected to channels 7 or 8, use an external pull-up resistor to +5V (prot +12 will also work).

Ground: any available ground

Description

This block reads all bits defined in Bit Selection from a Digital I/O module and outputs the binary or gray code value the data represents. The block allows the user to select the I/O module, the number of bits, the coding, and whether or not the data needs to be inverted.

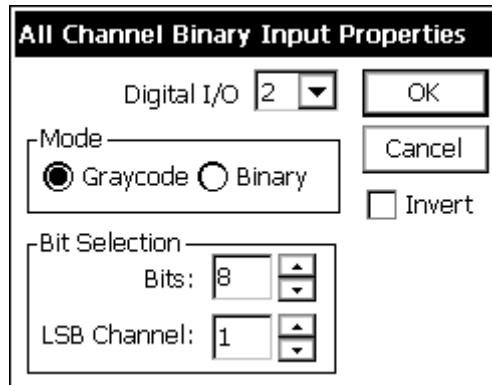

The coding options available are Binary and Graycode. Binary reads the input channels as binary bits, which it then converts to decimal (i.e.: LLLL HLHL = 0000 1010b = 10d). Graycode is a coding scheme where each sequential value only differs from its predecessor by one place. It is often used by absolute encoders so that slight misalignments between the reading elements will not result in widely incorrect readings. Notice, for example, that an increase from 3 to 4 causes two bits to change in binary but only one in Graycode:

Decimal	Binary	Graycode
0	000	000
1	001	001
2	010	011
3	011	010
4	100	110

5	101	111
6	110	101
7	111	100

The Bits value defines how many bits to convert, from six to eight. If less than eight bits are being converted, then set LSB Channel to the channel of the least significant bit.



Bridge Resistance (Bridge)

Inputs

<none>

Outputs

Output

Wiring

Wire to the Xpert as shown below. NOTE: DO NOT USE CHANNELS ABOVE 8 FOR EXCITATION

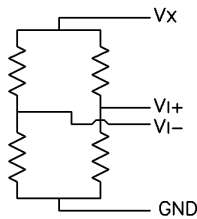

Description

This block reads a bridge type resistance sensor. These sensors typically require an excitation of 2 to 5 volts and a full scale output of 10 to 100 mV. To make this measurement, the Xpert makes a single ended measurement of the reference voltage and a differential measurement of the input voltage. The equation applied to the measured voltages is as follows:

$$\text{Output} = \text{Slope} * V_i/V_x + \text{Offset}.$$

The user set properties of the Bridge block are shown below. Note that the input is a differential measurement so select an odd numbered input channel:



CapRain (CapRain)

Inputs

<none>

Outputs

Rain

Wiring

Connect the sensor output to the selected analog channel.

Connect the sensor power to PROT 12 (B17) and GND (B16 or =)

Description

The CapRain block is designed to make measurements from an RM Young 50202 Capacitive Precipitation Gauge. It may also work with other rain gauges with an analog output. The RM Young 50202 sensor has an analog output (0-5 volts) corresponding to 0-50mm (0 to 2.5 inches) rain. The sensor automatically empties itself so the output will periodically go to zero.

The CapRain block has special processing designed to prevent measurements while the gauge is emptying the bucket. This processing takes two measurements of the gauge two seconds apart. If the output drops by more than 0.1 volts in this two-second interval the system sleeps for 5 seconds and then tries again. Up to six retries will be performed before the system logs an error. The block also has a special algorithm to accumulate the rain as though the bucket were not being emptied. If the current value measured has gone down by 1/5 of the range since the last measured value the software concludes that the gauge has emptied and adds 5*slope to the sensor offset. The value reported by the block is always reading + offset.

Note: You must get data from the CapRain block every 10 to 15 minutes so it can track the emptying. The maximum rain rate that can be handled by measurements every 10 minutes is 12 inches/hour and the maximum rate handled by measurements every 15 minutes is 8 inches/hour.

The block supports the calibration to a user entered current value. When the calibration function is run, the system prompts for the current level. It then uses the current level and the current reading to automatically set the offset. The calibration function should not be done when the system is emptying the gauge or while the gauge output is changing.

Enter the slope in the units that you desire. The slope for inches would be $0.5 = 2.5\text{inches}/5\text{volts}$. The slope for mm would be $10 = 50\text{mm}/5$.

The offset should normally be 0 for a new site with an empty gauge. As explained above, the offset can also be computed to force the gauge to a specific value.

The units should be set to in or mm as determined by the slope.

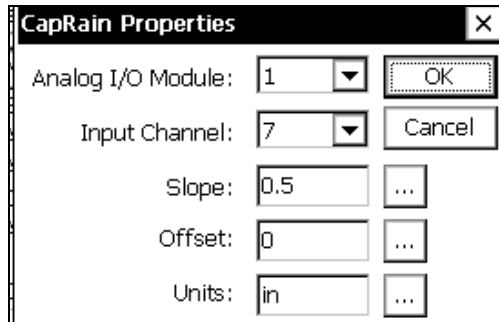



Constant (ConstIn)

Inputs

<none>

Outputs

Const

Wiring

None

Description

The constant block provides a constant value output. This can be valuable for testing setup diagrams before physical sensors are hooked-up, or in any other situation where a constant output is needed. A constant value may be modified via calibration or by setting the value of a connected ComsTag block using telemetry, the command line SET command, or the Data tab. This allows a constant block to be used for manual readings and other purposes. Modified values are stored back in to the setup file.

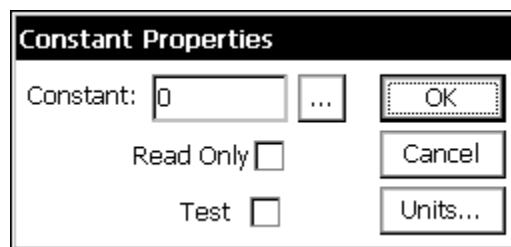

The *Read Only* check box may be used to prevent the constant value from being modified by means other than direct modification of the setup.

The *Test* check box is used to generate data that varies. This can be useful for system tests. When *Test* is checked the data will vary as follows:

Constant	Output
1	TickCount (ticks have units of milliseconds, not synchronized to any particular time)
2	Random Number between 1 and 32767
3	Output increases by 1

4	Output increases by 1 and delay 500 ms
---	--

The Units...button may be used to define the units for the constant value:



If Use these units is checked then the text entered below it is used as the units for the constant block, otherwise the units are passed on to the next block as blank.



Counter (Counter)

Inputs

<none>

Outputs

Count

DeltaCount

Freq

Wiring

Connect the device to the selected digital input.

Description

The Counter block is a general-purpose block for measuring a counter or frequency input. Each time the block is run, it collects counter information from the digital I/O module and then computes a delta count and frequency from the data collected the last time the block was run. As a result, the first time this block is run, the frequency and delta count output will not have valid data.

Filter is used to debounce noisy inputs. Most mechanical switches, like a tipping bucket output, have noise, so a filter should be used with switches. A value of 0 specifies no debouncing while a value of 1 to 255 requires the input to remain high for $\text{filter_value} \times 0.2$ ms in order for the system to register a count.

Along with computing the deltacounts and frequency, the block also scales the outputs according to the values of *Slope* and *Offset*.

The units for the outputs are forced to be Hz for Freq and CNT for Count and DeltaCount whenever the units are set to Hz. The user can change the units for all the outputs by changing the *Units* field on the property page to the desired value.

When *Reset Count* is checked, the count resets every time recording is started. If the counter has been calibrated, it will reset to the calibrated value, otherwise, it will reset to zero. If more than one counter block, or tipping bucket block, is used on the same input channel, all blocks would be reset to zero.

The Counter block supports calibration from the Sensors tab. For the calibration, the user will enter the current value for the counter. The system will then compute a special calibration offset that is applied to the counter.

Anytime recording is stopped and restarted, the counter should be calibrated to a known state, as any counts that have occurred during the time when recording was stopped, have been missed.

Counter Properties [X]

Digital Mod: 1 [v] [OK]

Digital Chan: 2 [v] [Cancel]

Filter: 5 [...]

Slope: 1 [...]

Offset: 0 [...]

Units: Hz [...]

Reset count:



CS107 Temperature Sensor (CS107Temp)

Inputs

<none>

Outputs

Temp

Wiring

Connect the Thermistor black wire to the selected signal channel of the analog module CH1..CHxx

Connect a precision 100K 0.1% resistor between CHx above and the selected excitation channel CH1..CH8. NOTE: DO NOT USE CHANNELS ABOVE 8 FOR EXCITATION

Connect the Thermistor red to GND

Do not connect the purple AG to anything. Keep it insulated so it will not contact anything.

Connect the clear shield to GND.

Description

This block measures a CS 107 temperature probe. The CS 107 uses a thermistor to measure temperature in air/soil or water over the range of -35 to +50C with an accuracy of about 0.5C.

The Xpert measures the CS107 using its special double voltage reading where it measures its excitation voltage in addition to the signal voltage. The nominal excitation voltage is 5 volts.

After making the measurement, the temperature is computed as follows:

$$R = VM * 100000. / (VX - VM)$$

Where R is the resistance of the thermistor, VM is the measured excitation voltage and VX is the measured signal voltage.

$X = 800000 / (R)$ (this converts the resistance to a format compatible with the published conversion polynomial.

$$\text{Temp} = a + b * X + c * X^2 + d * X^3 + e * X^4 + f * X^5$$

Where:

Temp = temperature in degrees Celsius

a = -53.4601; b = 90.807; c = -83.257; d = 52.283; e = -16.723; f = 2.211

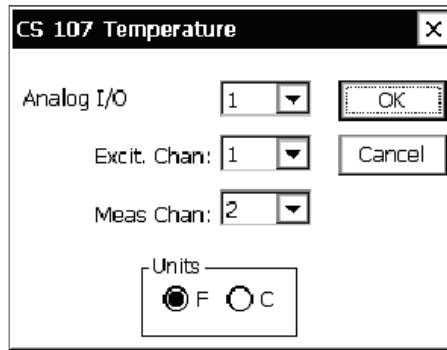



Frequency (Freq)

Inputs

<none>

Outputs

Freq

Wiring

Connect the sensor frequency output to the selected CH1..CH8 of the digital module.

Connect the sensor GND to GND.

Description

This block outputs the frequency of a digital input signal. First, select the Digital I/O Module and the channel number. Channels have a maximum frequency of 1KHz. The field *Multiplier* is normally left at one unless the cycles-per-second output of the frequency is to be changed. For example, to changing to cycles-per-minute, enter 0.0167 for this field.

The *Period* mostly has to do with when the block takes instantaneous (as opposed to continuous) frequency readings. For instantaneous readings, the Frequency block takes two time/count readings from the I/O module at *Period* time apart and used these to calculate the frequency of the signal. The longer the value entered for *Period* the greater the accuracy of the frequency (because of averaging) but the less “instantaneous” the reading will be.

When the frequency is being sampled frequently by a Measure or Average block, it might make sense to only take one time/count reading from the I/O module every pass, and calculate the frequency from the current and previous readings. For a sampling interval of 1 second, this would be the same as having the *Period* set to 1,000. If this is desired, un-check *Take Two Readings at a Time*, and set *Period* to 1,000. The Xpert will use the previous reading as long as it was taken within the time range of *Period* +/- *Period*/4 of the current time. Be careful how you set *Period* when *Take Two Readings* is unchecked. The smaller you make *Period*, the more likely the system will still take two measurements even though *Take Two Readings* is not checked. You should not make *Period* longer than the sampling interval of your measure or average block, or you will slow down data to the block. If you always want to use the previous reading to compute the frequency regardless of when it was measured, use the COUNTER block.

The block scales the outputs according to the values of *Slope* and *Offset* using the equation $output = reading * slope + offset$.

The user can change the units for all the outputs by changing the *Units* field to the desired value.

The block supports calibration from the Sensors page. For the calibration, the user will enter the current value. The system will then adjust the offset so the desired value is obtained.

Frequency Properties [X]

DIO Mod: 1 [v] Slope: 1 [] [...]

Channel: 1 [v] Offset: 0 [] [...]

Period (ms): 200 [] [...] Units: Hz [] [...]

Take 2 readings:

[OK] [Cancel]



Fuel Moisture (FM)

Inputs

<none>

Outputs

Fuel Moisture (FM)

Wiring

Connect the FM signal (to the selected input on the digital module (CH1)

Connect the FM enable to the selected input on the digital module (CH2)

Connect the GND to GND

Connect the FM Power to VBAT

Note: the digital module must have special code (part number 8080-0006-1).

Description

This block measures a CS505 Fuel Moisture sensor. The sensor has an output frequency in the range of 600 to 1500 Hz. A special version of the digital module 8080-0006-1 is needed to read these higher frequencies. The sensor also has a separate enable line to turn on and off the sensor as needed to make a measurement.

The equation used to convert the frequency to fuel moisture (percent) is as follows:

$$PP = (1 / \text{Freq}) * 1000$$

$$FM = C0 + C1*PP + C2*PP*PP$$

$$C0 = -220.14$$

$$C1 = 365.89$$

$$C2 = -114.96$$

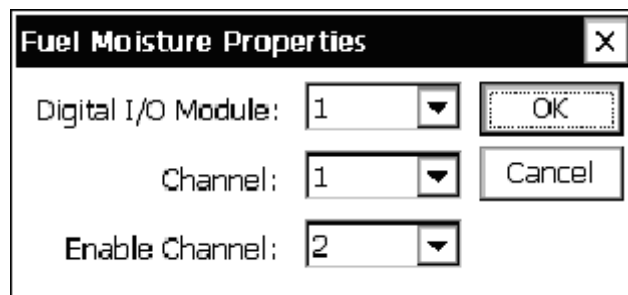



GetTag

Inputs

Outputs

Data

Description

This block gets the requested data from another station using Sutron Standard Protocol (SSP) communications. The properties for the block specify the port to use for the communications and the path or station name. The port can be specified only if you have first set up ports in the Coms (SSP/CL) entry on the Setup tab. The path can be a simple station name, or a station with full path information included (such as `\patha\pathb\stationx`). When the Port selection is “TCP/IP”, enter the URL to the destination. The Tag property must match the name specified in a COMS Tag in the named station.

For example, Station 1 is measuring water level and Station 2 wants to get the water level for its own use. Add a COMS Tag after the measure of the water level in Station 1. Set the COMS TAG *Name* property as WaterLevel. In Station 2, add a GetTag block connected to a measure. In the GETTAG properties, set the *Tag* property to WaterLevel. Also set the port and path for the link between the two stations. Now, whenever the GetTag block runs, the code will communicate to the named station and ask for WaterLevel. The station will reply with the data for WaterLevel and then the GetTag block will provide the data to connected blocks.

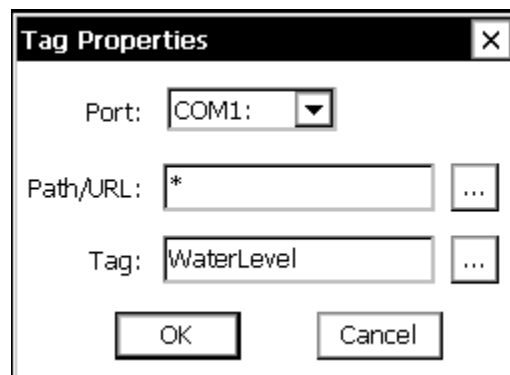



GillWind (Gill Wind Sensor)

Inputs

<none>

Outputs

WindSpeed

WindDirection

Wiring

Connect the sensor to a RS232 port as follows (wiring is shown for the 6461-1239 protection board:

Connector	Name	Pin (6461-1239)
2 V+	+12	6
5 TXD	RXD	2
7 RXD	TXD	3
1 GND, 3 V-	GND	5

Note: Set jumper J3 on the 6461-1239 to DTR

Configure Xpert for +12 on pin 9 of the DB9.

Gill sensor must be set up as follows:

M4, U3, O1, L1, P2, B3, F1, H1, HQ, E1, T1, S3, C1

Description

This block supports the Gill WindSonic ultrasonic wind sensor. This sensor has an RS232 serial output that can connect to one of the serial ports. The WindSonic has its own configuration and setup. The user must make sure the WindObserverII is setup to operate with the Xpert before connecting it, as it will not alter the setup of the sensor.

In setting up the sensor, the user can choose the output units, heater control and node address etc. The user must set the sensor block's "node address" property to the same address as the sensor.

The user must set the sensor as follows (see the Gill manual for further details):

Establish a connection from the sensor to a PC and turn on power to the sensor.

Enter configuration mode by sending * if the sensor is in continuous output mode, or sending *<node> if the sensor is in polling mode.

Send D3<CR> to display the current configuration.

Set the sensors to the following parameters (the manual explains how to do this):

WindSonic: M4,O1,L1,P1,B3,F1,H2,E1.

Set the units as desired with U, the heating with H, and the node address with N.

Send Q<CR> (Q is for Quit) when finished.

The setup of the Xpert to read the WindSonic is much easier. Simply specify the com port the sensor is connected to, the power setting and the address. **NOTE:** Leave the settings in the SETUP TAB/ COMS (SSP/CL) set to none, as this block will not be able to use the com port if Coms (SSP/CL) is already using it.

The Xpert will output the data in whatever units are set in the WindSonic.

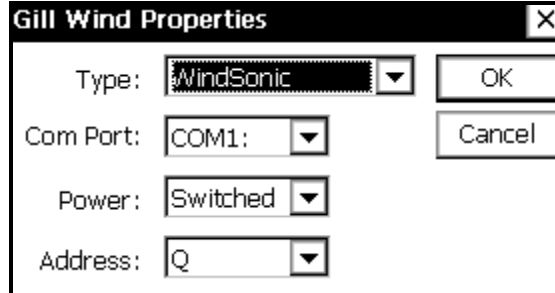



Heat Flux (HeatFlux)

Inputs

<none>

Outputs

Heat Flux

Sensitivity

Wiring

Two models of Hukesflux sensors are supported, HFP01 and HFP01SC. The latter model supports a periodic self-calibration procedure involving an onboard heating element.

HFP01

For single ended operation, connect the sensor's V+ to any analog input channel CH1.. CH10, and V- to AGND. For differential operation, connect V+ and V- to an adjacent input channel pair (e.g., 1 and 2, 3 and 4, etc.), and check the Differential checkbox.

HFP01SC

Connect as shown in the diagram, below.

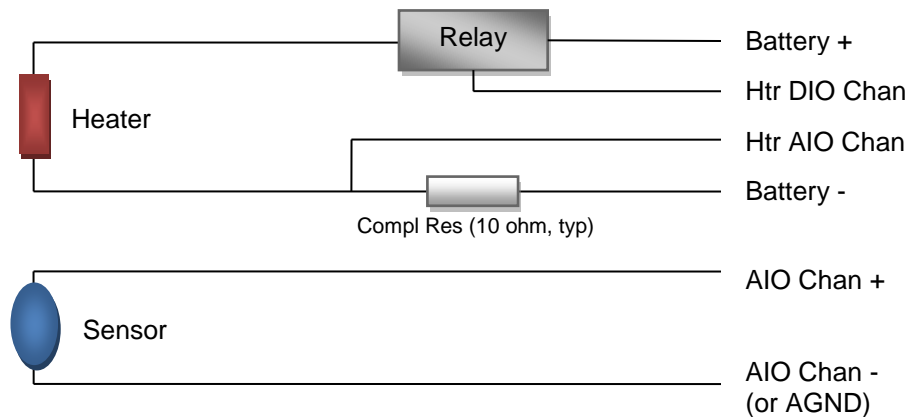

Description

The HeatFlux block is used to measure heat flux via a Hukesflux HFP01 or HFP01SC heat flux sensor. The following dialog is used to configure the sensor for measurement:

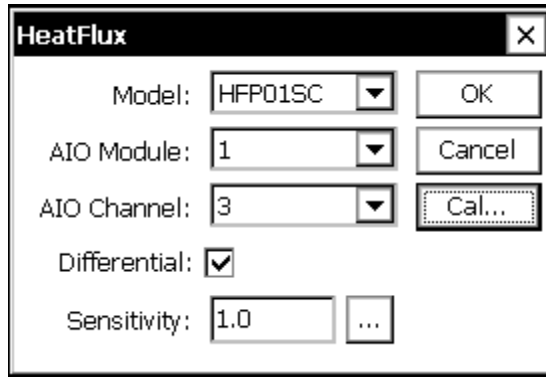

Select the type of heat flux sensor in Model, and specify the analog I/O module and channel in AIO Module and AIO Channel. Check the Differential checkbox, if the sensor has been wired for differential measurement. Enter Sensitivity from the manufacturer’s cal sheet.

Calibration

Press the “Cal...” button to configure model HFP01SC for calibration:

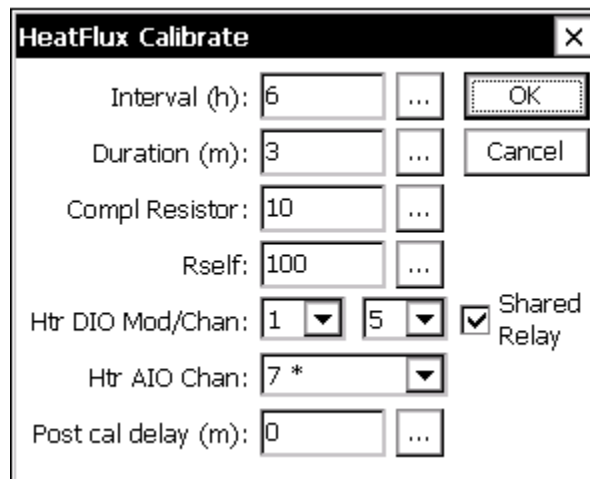

The calibration procedure involves periodically turning on a heating element to generate a known heat flux that can be measured to obtain a correction for measurements of unknown (environmental) heat fluxes.

Specify how often to perform a self-calibration in Interval (hours), and the length of the calibration in Duration (minutes).

Specify the value of the completion resistor in-line with the heater power supply (10 ohm, typically). Specify the Rself value provided by the manufacturer’s data sheet with the sensor.

Specify the digital I/O module and output channel used to control power to the heater in “Htr DIO Mod/Chan”.

Specify the analog input channel to which the resistor tap is connected in “Htr AIO Chan”.

Use “Post cal delay (m)” to specify the number of minutes to extend the calibration cool-down period.

When “Shared Relay” is checked, the system assumes the relay this HeatFlux block uses to control power to the heater is shared with other HeatFlux blocks. There may be only one shared relay. When “Shared Relay” is not checked, then the system assumes the relay for this block is not shared. Note: when sharing a relay, make sure the measurement schedules, and Interval and Duration properties, are set the same, for all HeatFlux blocks sharing the relay.



Internal Battery (IntBat)

Inputs

<none>

Outputs

Battery

Temp

Wiring

None, the sensors are internal to the Xpert.

Description

This block measures supply voltage and internal temperature. The temperature measurement is accurate to within ± 3 deg Celsius.

Note: the temperature measurement is that of the internal PC board, not air temperature.

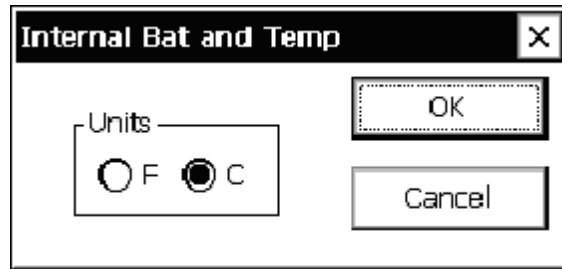



Log Input

Inputs

<none>

Outputs

LogVal: the value retrieved from the log

Wiring

None.

Description

This block retrieves the last value from the log for the sensor indicated. This block is most useful when data is logged by EzSetup or an Xpert Basic program, but needs to be processed in the Graphical Setup. When scheduling this block, be sure to schedule it so that it runs *after* the desired data is logged.

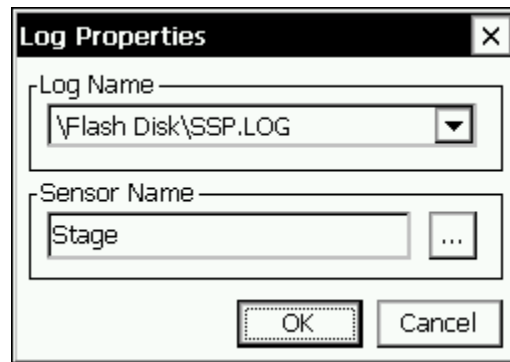



ML2x Soil Moisture Sensor (ML2x)

Inputs

<none>

Outputs

Dielectric

Moisture

Wiring

The sensor is measured single ended. Hence, connect the sensor's V+ to any analog input channel CH1.. CH10, and signal ground to AGND. Connect power as desired.

Description

The ML2x block is used to measure a Delta T ML2x soil moisture sensor. The following dialog is used to configure the block for measurement:

The screenshot shows a configuration dialog box titled "ML2x". It contains the following fields and controls:

- AIO Module: 1 (dropdown menu)
- AIO Channel: 4 (dropdown menu)
- Cal Method: Mineral (dropdown menu)
- a0: 1.6 (text input field)
- a1: 8.4 (text input field)
- Units: % (text input field)
- Buttons: OK and Cancel

AIO Module: select the analog module to which you connected the sensor.

AIO Channel: select the channel to which the sensor's V+ signal is connected.

Cal Method, a1, and a0: Select the method to use for calibrating the sensor measurement to the actual soil type. The possible selections are *Mineral*, *Organic*, and *User Cal*. *Mineral* and *Organic* are generalized calibrations for those two classes of soils, where predefined values of a0 and a1 are used to calculate moisture content. *User Cal* allows you to enter your own values for a0 and a1 that you determine through a soil specific calibration procedure. See the ML2x manual for more information on how perform this procedure.

Units: enter the string that should be used when displaying Moisture units.



MRL 700 Radar Sensor (MRL700)

Inputs

<none>

Outputs

dist

level

sigstr

Wiring and Configuration

NOTE: To use this block with the Xpert requires a unit with additional com ports configured as RS-485. Set the jumper for +12 volts to use power from this board.

Connect the sensor RS485 A to the RS485A (pin 3) and the sensor B to the RS485B (pin 2).

NOTE: Leave the settings in the SETUP TAB/ COMS (SSP/CL) set to none, as this block will not be able to use the com port if Coms (SSP/CL) is already using it.

The sensor must be configured to output in the following format: distance, signal strength with 9600 baud, 7bit, even parity, one stop bit. Configure the sensor to output 0.00 if it loses signal. For more information see the 8800-1146 MRL users manual.

Connect Power leads as configured below, either to GND and SW'D 12 (for AIO sw or DIO sw), or through a relay that is switching the battery and using the selected DIO channel for control.

Description

The MRL700 is used for measuring distance and, therefore, level. The properties dialog is used to specify configuration details required for proper operation.

“Reference” is used to specify the reference distance and is used to compute level.

“Warmup” is the number of seconds the unit should be powered on before taking a measurement. A typical warmup value is 30 seconds, this is the time the sensor needs to provide back reliable readings. If the values are to be averaged, make sure to set the average time to at least two times this warmup time (I.E. For 30 seconds of warmup the sensor should be averaged for at least one minute)

“Inactivity” is the number of seconds the unit should remain powered on following a measurement. This prevents the sensor from having to go through the warmup time for every reading I.E. If averaging every 5 seconds, setting this inactivity timer to 10 seconds, will keep power on between readings.

“PwrCtl” is used to specify how the sensor is to be powered on. When set to “DIO Sw”, DIO switched-12 is used to control power. When set to “AIO Sw”, AIO switched-12 is used to control power to the sensor. (On the Xlite, of course, AIO and DIO switched-12 are the same thing). When set to “DIO Chan”, the module and channel fields are used to determine the digital output used to control power to the sensor.

“Module” and “Channel” are used to designate the IO module used to control power to the sensor (Channel is applicable only when PwrCtrl is set to DIO Chan).

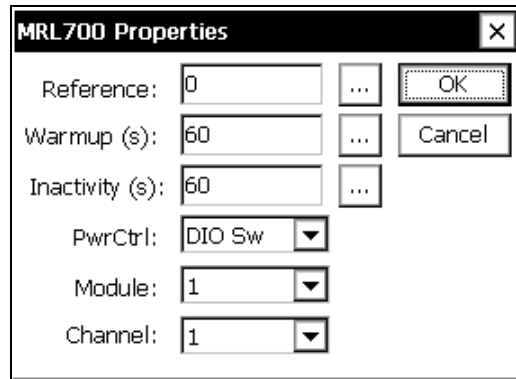

A typical averaging setup (using Ezsetup) would be as follows:

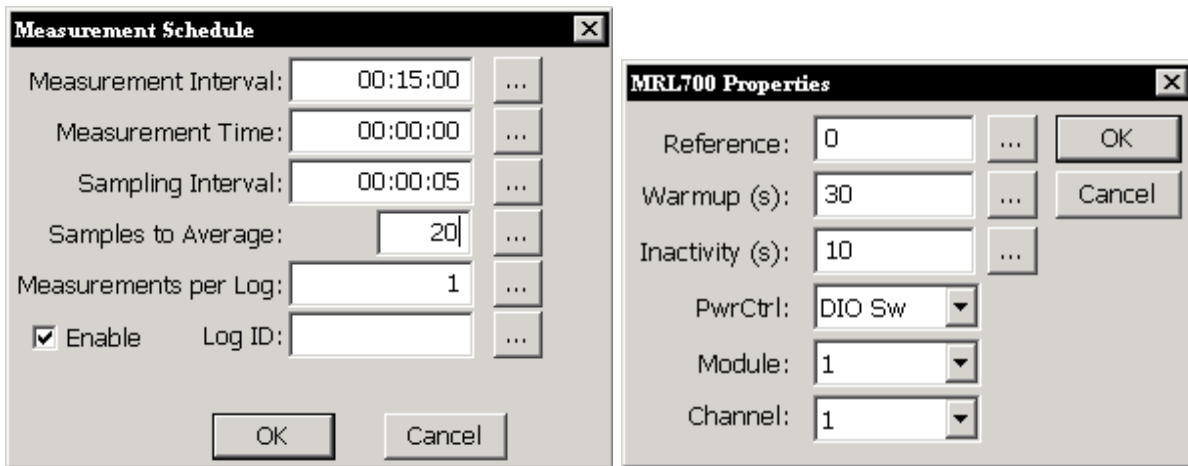

Using the measurement time starting at 00:00:00 and a 00:15:00 interval. will log the data with a timestamp at 00:01:35,00:16:35.....23:46:35.



Net Radiometer Sensors (NetRad)

Inputs

<none>

Outputs

NetRad

ShortRad (Up)

ShortRadDown

LongRad (Up)

LongRadDown

Wiring

Three sensor types are supported, and the wiring differs for each.

Kipp & Zonen NR Lite 2

For single ended operation, connect the sensor's V+ to any analog input channel CH1.. CH10, and V- to AGND. For differential operation, connect V+ and V- to an adjacent input channel pair (e.g., 1 and 2, 3 and 4, etc.), and check the Differential checkbox.

Kipp & Zonen CNR 2

For single ended operation, connect the two V+ signals to any two input channels CH1 .. CH10, and V- to AGND. For differential operation, connect NetWaveShort V+ and V- to an adjacent input channel pair, and connect NetWaveLong V+ and V- to an adjacent input channel pair (an "adjacent input channel pair" starts with an odd channel, e.g., 1 and 2, 3 and 4, etc.). Be sure to check the Differential checkbox.

Kipp & Zonen CNR 4

For single ended operation, connect the four V+ signals to any four analog input channels CH1 .. CH10, and V- to AGND. For differential operation, connect Pyrano and Pyrgeo pairs to adjacent input channel pairs (an "adjacent input channel pair" starts with an odd channel, e.g., 1 and 2, 3 and 4, etc.). Be sure to check the Differential checkbox.

Connect the V+ and V- thermistor leads similarly (V+ to input channel and V- to AGND for single ended, V+ and V- to an adjacent input channel pair for differential).

Connect the heater and ventilator grounds to GND, and connect the heater and ventilator leads each to a digital channel output.

Description

The NetRad block is used to measure one of three different net radiation sensors, the Kipp & Zonen NR Lite 2, CNR 2, and CNR 4. Each sensor differs in the components of radiation measured.

The NR Lite 2 is a high-output thermopile sensor that measures the sum of incoming and outgoing all-wave radiation (i.e., both short-wave and long-wave radiation). This sum is output via the NetRad block output. The other block outputs (ShortRad, LongRad, etc.), are ignored.

The CNR 2 also measures and outputs net total radiation in NetRad, but also measures and outputs net short-wave radiation in ShortRad and net long-wave radiation in LongRad.

The CNR 4 also measures and outputs net total radiation in NetRad, net short-wave radiation from above in ShortRadUp, net short-wave reflected radiation from below in ShortRadDown, net long-wave radiation from above in LongRadUp, and net reflected long-wave radiation from below in LongRadDown.

The following dialog is used to configure the sensor measurement:

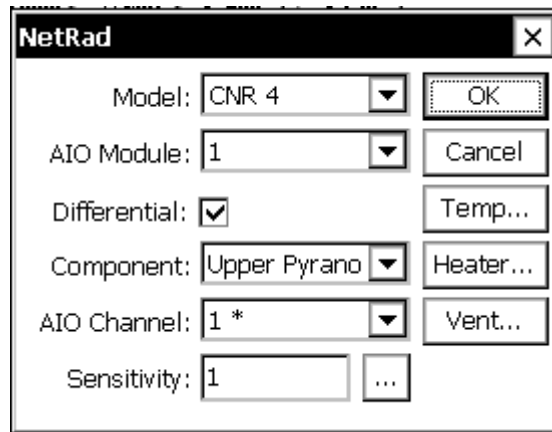

Model: Select the Model you wish to measure.

AIO Module: select the analog module to which you connected the sensor

Differential: check this box to measure the sensor input(s) differentially.

Component: when Model is either CNR 2 or CNR 4, use this drop-down to select which component to configure using AIO Channel and Sensitivity.

AIO Channel: the channel to which the sensor's V+ signal is connected. When Model is either CNR 2 or CNR 4, the channel applies to the selected Input.

Sensitivity: the sensitivity of the selected signal. When Model is either CNR 2 or CNR 4, the sensitivity applies to the selected Input. Expected units: $\mu\text{V}/\text{per W}/\text{m}^2$

Temperature

When CNR 4 is selected, configure the block to measure temperature by selecting the Temp button, and entering the AIO module and channel to which the temp signals have been connected. Also enter the value of the completion resistor in ohms you used when wiring up the thermistor.

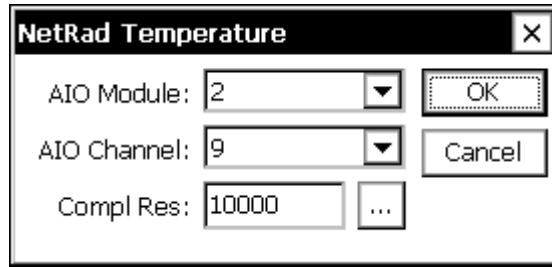

Heater and Ventilator

The CNR 4 optionally includes a Heater and Ventilator. The heater can be used to melt frost, and the ventilator is used to provide efficient air-flow over the domes and windows to minimize the formation of dew and reduce the frequency of cleaning.

The following dialog shows the properties used to configure CNR 4 heater operation. Ventilator configuration occurs in the NetRad Ventilator dialog, which looks and functions exactly the same.

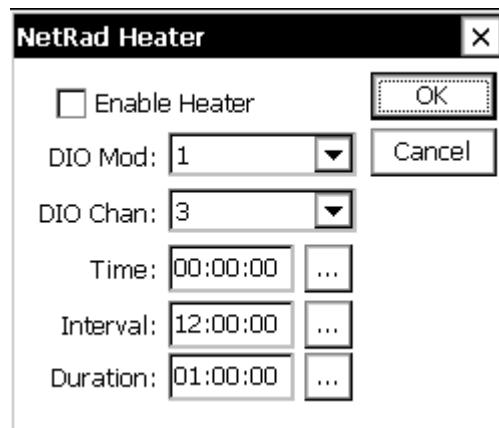

To enable heater operation, check the Enable Heater checkbox. When enabled, the system turns on the heater for the specified Duration, according to the specified schedule in Interval and Time. For example, if Time is “00:15:00”, Interval is “12:00:00”, and Duration is “01:00:00”, then every 12 hours at 12:15:00 and 00:15:00, the system will power the heater for 1 hour.



Airmar PB200/200WX (PB200)

Inputs

<none>

Outputs

Dir – Wind Direction, degrees true

Speed – Wind Speed, m/s

BP – Barometric Pressure, bar

AT – Air Temperature, C

RH – Relative Humidity, %

DP – Dew Point, C

LAT – Latitude

LON – Longitude

Description

The Airmar PB200/200WX sensor measures (or calculates) several meteorological parameters, including wind speed, wind direction, barometric pressure, air temperature, relative humidity, and dew point, as well as GPS position (LAT/LON) and UTC time. The Xpert “PB200” setup block enables you to read these parameters into the Xpert for further processing and/or logging. The following sections describe how to wire and configure the sensor for use with the Xpert.

Wiring

Connect the PB200/200WX sensors to an RS232 or RS485 serial port. Connect the sensor as shown in the table, below.

PB200 Pin #	PB200 Pin Name	Wire Color	RS485 Connection	RS232 Connection
1	V+	Red	V+	V+ (see PwrCtrl)
2	V-	Black	V-	V-
3	A/+ OUT	White	RS485A	Tx
7	A/+ IN	Yellow	RS485A	Rx
8	B/- IN	Orange	RS485B	N/C
9	B/- OUT	Blue	RS485B	N/C

Configuration

The PB200 properties dialog shown below is used to configure operation of the PB200 block.

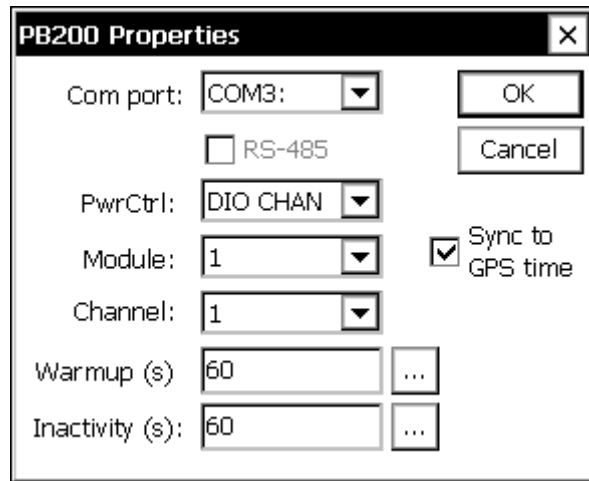

Com Port and RS-485

Use the **Com Port** property to select the port on which you've connected the PB200/200WX sensor. If you've connected the sensor to an RS485 port, then check the **RS-485** option (note, COM4 and COM6-COM9 are available as RS485 by factory option on the Xpert).

Power Control

The **PwrCtrl**, **Module**, and **Channel** properties control when and how the sensor is powered. Power to the sensor can either be switched or constant. The following table describes connections and behavior for the different values of **PwrCtrl**:

PwrCtrl	Connections and Behavior
AIO SW12	Connect sensor V+ to the SWBATT terminal of a connected AIO module. Set the Module property to the number of the connected module.
DIO SW12	Connect sensor V+ to the SWBATT terminal of a connected DIO module. Set the Module property to the number of the connected module.
DIO CHAN	This option is used when connecting sensor power to an external relay controlled by an Xpert digital output channel. Connect sensor V+ to the power supply terminal of the relay. Connect the relay control signal to the DIO module output channel. Set the Module property to the number of the DIO module. Set Channel to the number of the output channel controlling the relay.
PROT 12	Connect sensor V+ to a connector that provides constant 12V

Warmup (s)

The PB200/200WX takes several seconds following power-on before valid data is produced. The Warmup property is used to define how long to wait before attempting to read data from the

sensor after it is first powered on. Increase this value until the Xpert no longer consistently logs this sensor's data with BAD quality following sensor power-on. Note: this property is ignored when PwrCtrl is set to "PROT 12".

Special note for averaging: the Average and VecAvg blocks require at least 50% of the incoming samples to be of good quality, in order for the averaged values to be set to good quality. Hence, either the average block's sampling duration must be over twice the warmup time, or the inactivity timeout (below) must be set to ensure the PB200 is powered on for subsequent measurement intervals.

Inactivity (s)

This property defines how many seconds of inactivity (no measurements) may occur after a measurement before the sensor is powered down. Since the PB200/200WX sensor takes several seconds following power-on to produce valid data, it often makes sense to not turn off power to the sensor during times of frequent measurements (e.g., when averaging for only a portion of a measurement interval).

To ensure the sensor is not powered off before the next sample, set Interval to a value greater than the measurement interval. If instead you wish the sensor to power off after each sample (and therefore force the sensor to wait the Warmup time on every measurement), then set Interval to some small value (e.g., 0).

Sync to GPS Time

This property determines whether the PB200 block should set the Xpert system time to the UTC time obtained from the PB200/200WX sensor.



Platinum RTD (PlatRTD)

Inputs

<none>

Outputs

PlatRTD

Wiring

Connect the sensor to channels 1,2; 3,4; etc. as selected for a differential measurement. Connect the sensor as shown below.

NOTE: DO NOT USE CHANNELS ABOVE 8 FOR EXCITATION

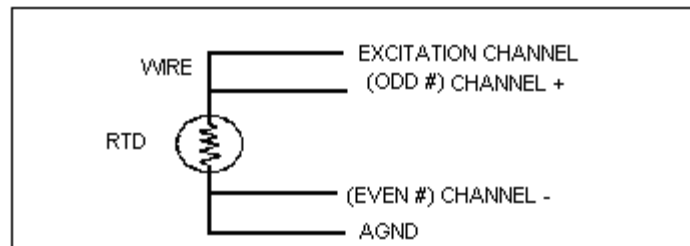

4-wire mode

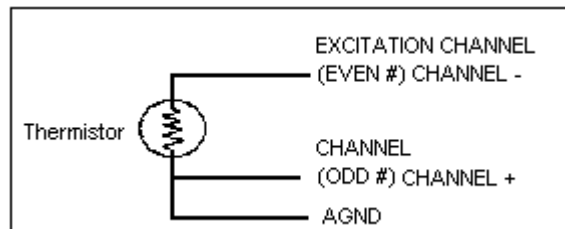

3-wire mode

Description

The Platinum RTD block is used for measuring a 100 ohm platinum temperature devices. The dialog allows the selection of the block channel and excitation. The type is also selectable between 385 and 392 type devices. The resistance at zero degrees can be set for calibration purposes. The system will do a differential measurement so always select an odd channel number (1, 3, 5...).

In 3-wire mode, set the “Channel” to the odd # channel (e.g. 1, 3, 5) and “Excitation Ch” to the even channel pair (e.g. if "Channel" is 1, then “Excitation Ch” is 2, if "Channel" is 3 then “Excitation Ch” is 4, etc.).

Note: high resolution readings will take longer than non-high resolution readings.

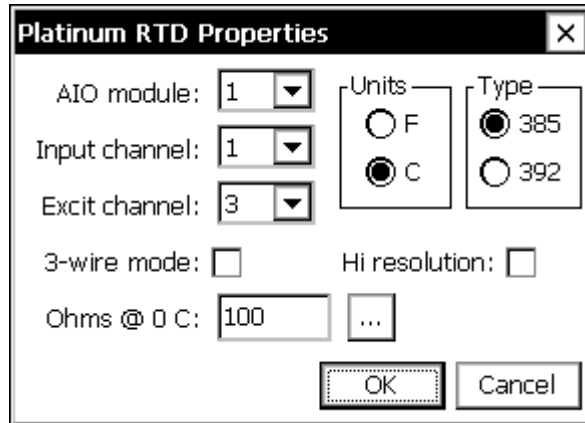

Note: If the Platinum RTD conforms to DIN 43760, IEC 751, or IEC 60751, then select type 385.



Quadrature Shaft Encoder

Inputs

<none>

Outputs

Level

Wiring

Wire the pair of quadrature outputs to digital channels 1 and 2, 3 and 4, 5 and 6, or 7 and 8. If counts are in the wrong direction, either reverse wires or change the rotation setting in the properties.

Power the sensor off +12V and GND.

Description

This block is used to collect data from an incremental/quadrature shaft encoder through a Digital I/O Module. Up to four Quadrature shaft encoders may be set up on one module. The signal lines from each encoder must hook-up to adjacent I/O module inputs starting with an odd-numbered one (i.e.: 1,2; 3,4; 5,6; or 7,8).

Select the module and channel pair number the encoder is hooked-up to (odd channel - 3, 5 or 7). Enter the wheel diameter, the rotation direction that results in a positive increase to the output, and the units for the block to output in. The Counts per Turn drop down box allows you to select 100, 256, 400 and 800 counts per turn in order to support different shaft encoders.

The quadrature shaft encoder block contains a calibrate procedure. The calibrate procedure is used to set the reading to a user set value. This is important to do whenever the Xpert is restarted or maintenance is done on the sensor. The calibration procedure is run from the Sensors tab.

The image shows a dialog box titled "Quadrature Shaft Encoder Properties". It contains the following fields and controls:

- DIO Module:** A dropdown menu set to "1" with an "OK" button to its right.
- Channel:** A dropdown menu set to "3" with a "Cancel" button to its right.
- Wheel Circumference:** A dropdown menu set to "1 Foot".
- Other Circumference:** A text input field containing "1" and a button with three dots "...".
- Counts per Turn:** A dropdown menu set to "100".
- Rotation:** Two radio buttons: "CW" (which is selected) and "CCW".
- Units:** Two radio buttons: "ft" (which is selected) and "m".



R.M. Young Wind Sensor (RMYoung)

Inputs

<none>

Outputs

Speed

Dir

Wiring

Wind Direction

AZEXC	Connect to selected excitation channel on the analog module (V _x) NOTE: DO NOT USE CHANNELS ABOVE 8 FOR EXCITATION
AZSIG	Connect to selected input channel on the analog module (V _i).
REF	Connect to GND

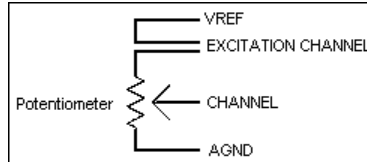

Powered Sensors

WS Sig connect to selected input channel (CH1..CH6) of digital module. Note CH7 and CH8 reserved for non-powered sensors with low level outputs.

V+ Supply connect to VBAT

REF connect to GND

Non-Powered Sensors

WS Sig connect to digital CH7 or CH8 of digital module

Note: The direction potentiometer of most models of the RM Young wind sensor has a 5 degree electrical open from 355 to 360 degrees. A one megohm resistor can be placed from the AZSIG (input channel) to AZEXC (excitation channel) or AGND to define the direction as 355 degrees (AZEXC) or 0 degrees (AGND) in the open region.

Description

This block is designed to make measurements from an R.M. Young wind sensor, models 5103 or 5305. One analog input and one excitation channel (analog output) is needed on an Analog I/O

module to determine wind direction. Wind direction requires connection to Digital Module input channel. The units for wind speed can be set to mph, mps, kph, fps, or knots.

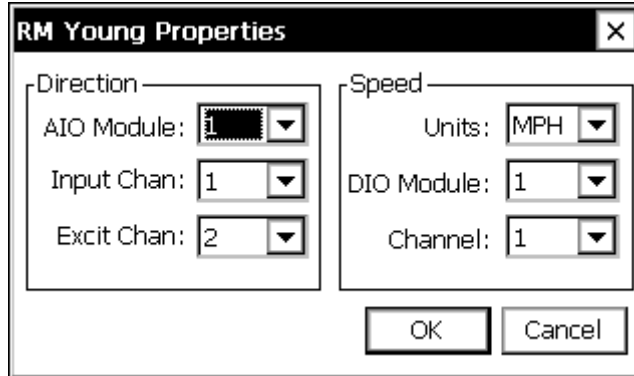

SDI 12 SDI-12

Inputs

<none>

Outputs

Output 0

...

Output 19

Wiring

All SDI-12 sensors wire to GND, +12 and Data on the Xpert. Multiple wires can be connected to the same connections.

Description

This general-purpose sensor block is used to obtain data from a SDI-12 sensor (parameters 1 through 20; to retrieve a parameter above 20, please use the Xpert Basic “SDICollect” function).

Select the SDI-12 address of the sensor, the measurement command type* and the units to report with the reading. The C (concurrent measurement) command is only supported by SDI sensors versions 1.3 and higher.

*NOTE: The only supported commands are V, M, MC, M1 - M9, C, CC, C1 - C9, R0-R9, RC0-RC9. To get other types of measurements, a basic program using the SDI function must be used (SdiCollect does not work, so data must be parsed by the program).

The block scales the outputs according to the values of *Slope* and *Offset* using the equation $output = reading * slope + offset$.

The user can change the units for all the outputs by changing the *Units* field to the desired value.

The block supports calibration from the Sensors page. For the calibration, the user will enter the current value sensor. The system will then adjust the offset so the desired value is obtained.

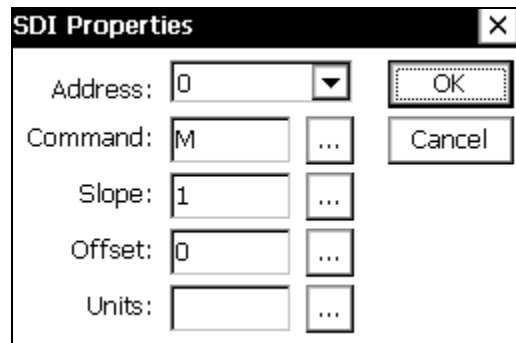



SDI AquaTrak (SDIAqua)

Inputs

<none>

Outputs

Average

Std

Outliers

Cals

Quality

Wiring

SDI-12 port

Description

The SDI AquaTrak block is designed to operate with the Aquatrak 4100 series controller and sensor heads for measuring water level. The Aquatrak sensor must be configured separately to specify the measurement modes and desired averaging algorithm and number of samples to take. The typical configuration uses the NOS DQAP algorithm measuring 181 samples.

Once configured, the Xpert will make measurements using the standard SDI M command or C command, if Concurrent is selected.

Testing has shown that the Aquatrak controller tends to ignore the retries that come very quickly as part of the normal SDI-12 retry process. Hence, this block performs an additional retry after the user-specified Retry Delay. This delay should be set to 2000 minimally when Concurrent is selected, and set to 3000 minimally when Concurrent is not selected.

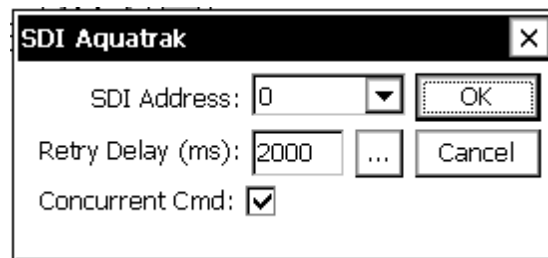



SE8500 (SE8500)

Inputs

<none>

Outputs

Output

Wiring

The SE8500 can connect to any of the Xpert serial ports. The SE8500 wires to the 6461-1239 termination board as follows:

Color	Name	Pin (6461-1239)
Red	+12	6
BLK	GND	5
White	TXD	3
Green	RXD	2

Description

This block measures a SE8500 configured for serial output. It can also work with an SE8500 connected to a wireless link. The properties allow setting the Com Port, range, offset, address and units. **NOTE:** Leave the settings in the SETUP TAB/ COMS (SSP/CL) set to none, as this block will not be able to use the com port if Coms (SSP/CL) is already using it. Address specifies which address the SE8500 is set to. Typically address is 0. Other valid addresses are 1..9, A..F.

After the value is read from the SE8500 it is scaled as follows:

$$\text{Value} = \text{reading} * \text{range} + \text{offset}.$$

Range is typically 0.01 because the SE8500 multiplies its value by 100 before sending it. However, you can select a different range value if desired.

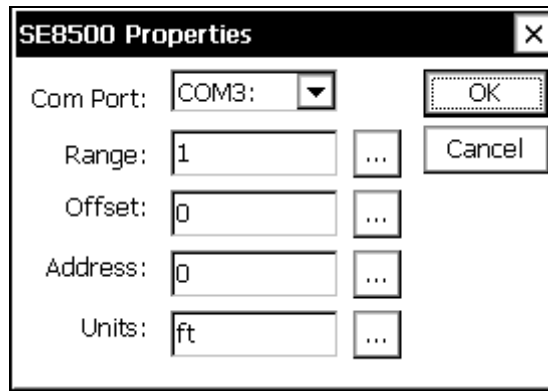



Send Current Time (SendTime)

Inputs

<none>

Outputs

<none>

Description

This block is used to synchronize the system time of connected units that “speak” SSP (i.e., other 9210s, Xperts, 8210s, etc.). This block sends an SSP “set-time” message containing the current system time to the destination unit(s) specified by the “Path” property. The message is sent periodically according to the scheduling parameters “Time” and “Interval”.

To broadcast the set time message to all listeners, set the “Path” property to “*”. Otherwise, enter a specific station name or station path (e.g., `\patha\pathb\stationx`).

Set the “Port” property to the communications port to which the other device(s) is(are) connected. This com port must already be defined in the Setup tab under COMS (SSP/CL).

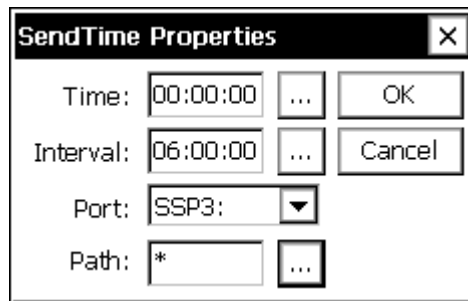



Soil Moisture (SoilM)

Inputs

<none>

Outputs

Dielectric

Moisture

Temp

Wiring

Connect the sensor output (green) to the selected channel on the analog module.

If the Type is moisture+temperature, connect the temperature output (blue) to the next higher channel.

Connect the sensor ground (white) to GND

Connect the sensor power (red) to SW'D 12V.

Description

This block supports Sutron's 5600-0089 soil moisture/temperature sensor. The type box supports the following:

Moisture	measure moisture only
Moisture+temperature	measure moisture and temperature on a separate channel
Moisture+temp muxed	measure moisture, wait 5 seconds, then measure temperature on the same channel

The "use digital" check box allows you to specify a digital channel to enable individual sensors (see page 8 of the sensor manual for more details).

The cable correct check box directs the software to apply the cable offset correction as explained on page 12-13 of the sensor manual.

Soil Moisture Properties [X]

Type: moisture [v] [OK]

Analog Mod: 1 [v] [Cancel]

Analog Chan: 1 [v]

Use Digital:

Digital Mod: 1 [v]

Digital Chan: 1 [v]

Cable Correct: Length: 111 [v]



Soil Temperature (SoilTemp)

Inputs

<none>

Outputs

Soil Temperature

Wiring

The sensor is measured single ended. Hence, connect the sensor's V+ to any analog input channel CH1.. CH10, and signal ground to AGND. Connect power as desired.

Description

The SoilTemp block is used to measure soil temperature sensors. The following dialog is used to configure the block for measurement:

The dialog box titled "SoilTemp" contains the following fields and controls:

- Model:** A dropdown menu with "LI-COR 7900-180" selected.
- AIO Module:** A dropdown menu with "1" selected.
- AIO Channel:** A dropdown menu with "7 *" selected.
- Units:** A group box containing two radio buttons: "F" (unselected) and "C" (selected).
- Buttons:** "OK" and "Cancel" buttons are located to the right of the dropdown menus.

Select the type of soil temperature sensor in Model, and specify the analog I/O module and channel in AIO Module and AIO Channel. Select the Units for the output.



Solar Radiation (SolRad)

Inputs

<none>

Outputs

SolRad

Wiring

Connect the sensor output to the selected channel on the analog module CH1..CH6

Connect the sensor ground to GND.

Description

This block supports all the solar radiation sensor sold by Sutron, part numbers 5600-0600, -0601, -0602, -0603, and -0605. All of these utilize one channel (analog input) on an Analog I/O module. Select the sensor part number and the units for the block to output in. The *Calibration* is used in the equation:

Solar Radiation = mv/calibration.

The units for *Calibration* are typically millivolts per watt per meter squared. The sensor manufacturer typically supplies the value for calibration. If the units supplied by the manufacturer are in a different format, convert them prior to entering the calibration value.

Specify in “Warmup (ms)” the number of milliseconds the I/O module should wait before taking the measurement. This wait time allows the module to settle in order to make an accurate measurement.

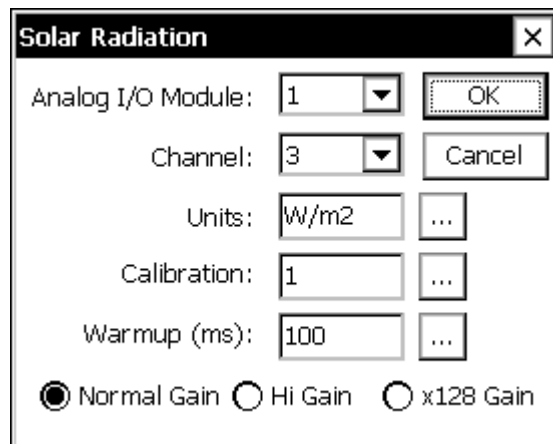

With the exception of the 5600-0604, the Hi Gain setting is typically used for solar radiation sensors. It is possible to use the x128 setting if the expected range of irradiance is low enough to ensure that the output voltage will be less than 19 mV, but due to the high resolution of the analog to digital converters used, there is rarely a need for the x128 range.

When using Hi Gain, the input voltage should be less than 312mV when using the 8080-0003 Analog I/O Module, and less than 78mV when using the 8080-0007 Analog I/O Module. When using x128 Gain, the input voltage should be less than 39mV when using the 8080-0003 Analog I/O Module, and less than 19mV when using the 8080-0007 Analog I/O Module.

See the table below for the voltage ranges of Sutron Solar Radiation sensors. A check “√” in a gain column means the selected gain is appropriate for that sensor. An “x” in a gain column, means the selected gain is not appropriate for that sensor.

Part Number	Max Output	Normal Gain	Hi Gain	x128 Gain
5600-0600	Typ. 40 mV @ 3000 W m ⁻²	x	√	√
5600-0601	30 mV @ 2000 W m ⁻²	x	√	√
5600-0602	Typ. 25 mV @ 2800 W m ⁻²	x	√	√
5600-0603	Typ. 30 mV @ 10,000 μmol s ⁻¹ m ⁻²	x	√	√
5600-0604	Typ. 200 mV @ 2000 W m ⁻²	√	√*	x
5600-0605	70mV @ 2000 W m ⁻²	x	√	√

* - Acceptable only when measured using 8080-0003 Analog I/O module.



Submersible Pressure Transducer (SubPres)

Inputs

<none>

Outputs

PressEng

Wiring

Wire to SDI-12 port

Description

This block supports the Sutron 56-109 Submersible Pressure Transducer. This SDI-12 sensor is used to measure water level or pressure in well or surface water applications. The averaging time can be used to increase the measurement accuracy by lengthening the sampling time, and/or for situations where there are waves on the water surface. Unit options are ft, PSI, kPa, m, cm, or mm.

The screenshot shows a dialog box titled "Submersible Pressure Properties" with a close button (X) in the top right corner. The dialog contains the following fields and controls:

- SDI Address:** A dropdown menu showing the value "0".
- Averaging time:** A text input field containing "10", followed by an ellipsis button "...".
- Offset:** A text input field containing "0", followed by an ellipsis button "...".
- Units:** A dropdown menu showing the value "water ft".
- Buttons:** "OK" and "Cancel" buttons are located on the right side of the dialog.

T_B Tipping Bucket Sensor (Precip)

Inputs

<none>

Outputs

Precip

Wiring

Connect one side of the tipping bucket switch to the selected digital channel.

Connect the other wire to GND.

Description

This block works with reed, wetted reed, and magnetic tipping buckets. The tipping bucket output hooks to one input of a Digital I/O module. Set *Tip* to the amount of rainfall associated with one bucket tip. The supported Tips are 0.1mm, 0.2mm, 0.25mm, 0.3mm, 0.5mm, 1.0mm, 0.01", and 0.008". *Filter* can be increased to eliminate extra readings due to bucket bounce; however, the default value should suffice for most units. The output of this block is the total amount of rain that has fallen since sampling began.

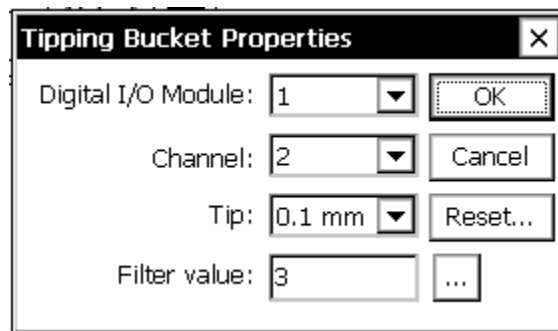

Reset

The tipping bucket block can reset to 0.0 according to a schedule you specify, if desired. Press the "Reset" button to bring up the following dialog to configure the reset:

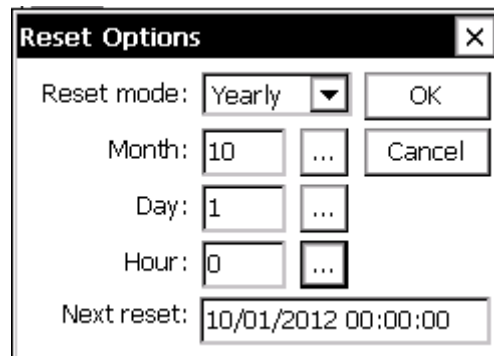

Set “Reset mode” to either None, Yearly, Monthly, or Daily. Set Month, Day, and Hour to indicate the desired time to reset. Month ranges from 1 to 12, Day from 1 to 31, and Hour from 0 to 23. In the example shown above, the reset will occur every year, at midnight October 1st. Note how the next reset is computed shown. This can help you figure out if your settings will produce the desired result.

Calibrate

The tipping bucket block contains a calibrate procedure. The calibrate procedure is used to set the reading to a user set value, or to run a calibration test. This is important to do whenever the Xpert is restarted. The calibration procedure is run from the Sensors tab, Calibrate button.

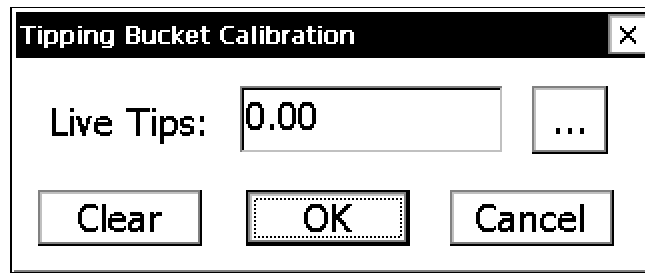

When the calibration is entered, the old value of the tipping bucket is preserved and is “locked”. This means that if recording is still on and the system measures or logs the tipping bucket, the old value is used. The “Live Tips” display always starts out initially at zero and updates very rapidly. It will increment as the tipping bucket tips. You may enter a new value by pressing the [...] button. To restore the old value and return to normal operations at any time just press the cancel button. To accept the displayed value and make it become the new value, press the OK button.

To test the tipping bucket, enter the calibration screen, add a specific amount of water to the tipping bucket, and observe the read-out. Press cancel when done.

To correct the tipping bucket, enter the calibration screen, press the [...] button, and enter the correct value. Press ok when done.



Volt Meter (VoltMeter)

Inputs

<none>

Outputs

AIOVolt

Wiring

Connect the voltage output to the analog channel selected CH1..CH6.

Connect a ground from the sensor to GND

Description

VoltMeter is a general-purpose block for measuring a voltage from an Analog I/O module analog input. User selections are available for the I/O module and channel (analog input), warm-up time, slope, offset and reported units.

The formula for calculating the reading is: $Output = V_{in} * Slope + Offset$

Default units is "volts", this may be changed to match desired reading (I.E. "Degrees C").

The *Settling Time (Warm Up)* can be adjusted to adapt either to long sensor signal settling times, or to give the voltage reference in the Analog I/O Module a longer time to warm-up for increased converting accuracy.

The block scales the outputs according to the values of *Slope* and *Offset* using the equation $output = reading * slope + offset$.

The user can change the units for all the outputs by changing the *Units* field to the desired value.

The block supports calibration from the Sensors page. For the calibration, the user will enter the current value sensor. The system will then adjust the offset so the desired value is obtained.

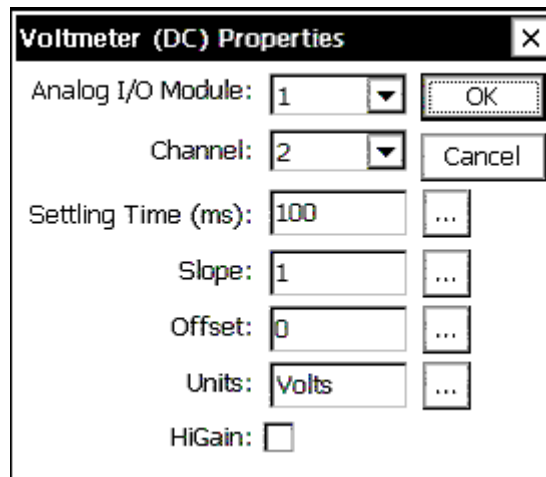



Vibrating Wire (VWire)

Inputs

None

Outputs

None

Wiring

One or more Campbell Scientific AVW200 Vibrating Wire Interface devices connected to RS232 com ports. See AVW200 documentation for wiring of vibrating wire sensors to it.

Description

The Vibrating Wire block measures vibrating wires connected to one or more Campbell Scientific AVW200 Vibrating Wire Interface devices. The AVW200 devices are connected to the logger via RS232 COM port.

The block does not have any properties to configure in the graphical setup. Instead, a comma-separated-value (CSV) text file is used to define the configuration. Here's an example CSV file:

```
Name,Enabled (Y/N),Time (HH:MM:SS),Interval (HH:MM:SS),COM Port,Channel (1/2),A,B,C,K,T0,S0,S1 Name
PZ72A,Y,0:00:00:000,0:00:05,COM3:,1,-7.395E-08,-0.02281,212.0283952,0.01279,21.01535,992.3,
PZ72B,Y,0:00:01:700,0:00:05,COM3:,2,-9.019E-08,-0.02363,216.9210467,0.005873,21.13562,992.3,
PZ72C,Y,0:00:00:450,0:00:05,COM4:,1,-7.395E-08,-0.02281,212.0283952,0.01279,21.01535,992.3,
PZ72D,Y,0:00:02:150,0:00:05,COM4:,2,-9.019E-08,-0.02363,216.9210467,0.005873,21.13562,992.3,
PZ74A,Y,0:00:00:900,0:00:05,COM7:,1,-7.395E-08,-0.02281,212.0283952,0.01279,21.01535,992.3,
PZ74B,Y,0:00:02:600,0:00:05,COM7:,2,-9.019E-08,-0.02363,216.9210467,0.005873,21.13562,992.3,
PZ74C,Y,0:00:01:350,0:00:05,COM8:,1,-7.395E-08,-0.02281,212.0283952,0.01279,21.01535,992.3,
PZ76A,Y,0:00:03:050,0:00:05,COM8:,2,-9.019E-08,-0.02363,216.9210467,0.005873,21.13562,992.3,
PZ76B,Y,0:00:01:800,0:00:05,COM9:,1,-7.395E-08,-0.02281,212.0283952,0.01279,21.01535,992.3,
PZ76C,Y,0:00:03:500,0:00:05,COM9:,2,-9.019E-08,-0.02363,216.9210467,0.005873,21.13562,992.3,
```

The fields of the file are defined as follows:

- "Name": the desired tag name for the computed water level. The tag name may refer to the name of a ComsTag block in the graphical setup, which can then be measured to log and/or transmit measured values
- Enabled: "Y" or "N". Setting to "N" disables the measurement
- Time and Interval determine the measurement time and interval, and should be formatted "HH:MM:SS"
- COM Port: name should include the colon, e.g., "COM2:", "COM3:", etc.
- Channel (1/2): The AVW200 channel to measure (either 1 or 2)
- A, B, K, T0, and S0 readings come from Geokon 4500S cal sheet
- C is typically a calculated value. It can be computed initially based on calibration sheet information. It can be recalculated in field during installation, if desired, to improve accuracy
- S1 Name: Reference Barometric correction. This is optional. If unused, leave blank

PROCESSING BLOCKS



Alarm

Inputs

Input

Outputs

Hi Alarm – True (1) if the data is in Hi Alarm, otherwise false (0)

Lo Alarm – True (1) if the data is in Lo Alarm, otherwise false (0)

Data – pass through of the data

ROC Alarm – True (1) if the data is in ROC Alarm, otherwise false (0)

Any Alarm – True (1) if the data is in any alarm, otherwise false (0)

Description

The Alarm block checks the input data for alarms. The Alarm Properties allow the Alarm block to be configured to detect Hi Alarms, Lo Alarms and ROC Alarms. The same deadband applies to all types of alarms.

The Alarm block is also used to configure the unit to send out ALERTS (transmissions due to alarm). See the following chart for details:

HI Mode and LOW Mode	OFF	Do not send out an alert, only go into alarm.
	ABOVE	Send an alert when the value goes above the HI limit + deadband
	BELOW	Send an alert when the value goes below the HI limit - deadband
	BOTH	Send an alert when the value goes above the HI limit + deadband OR when the value goes below the HI limit - deadband
Alert on ROC Alarm	Checked	Send an alert based on the ROC mode. Above or Below.
	UNChecked	Do not send out an alert.

Alerts will only occur when the conditions set above are met, and will continue until acknowledged (note: alerts over Iridium and/or GPRS are effectively acknowledged once the transmission completes).

Once in alarm, the unit will stay in alarm until the conditions are no longer met. Certain devices under the COMS (SSP/CL) menu can have alert disabled, see the section under COMS for more

information. If the unit is configured under the COMS (SSP/CL) menu to send data at an ALARM interval (anything other than 00:00:00) the unit will continue sending out that data.

Note: Iridium and GPRS devices are not managed under the COMS (SSP/CL) menu, and are not subject to the ALARM interval.

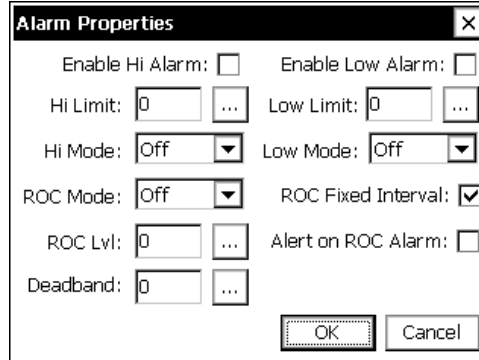

Hi Alarm	Go into alarm if the input value is $> \text{Hi Limit} + \text{deadband}$
	Go out of alarm if the input value is $< \text{Hi Limit} - \text{deadband}$
Low Alarm	Go into alarm if the input value is $< \text{Low Limit} - \text{deadband}$
	Go out of alarm if the input value is $> \text{Low Limit} + \text{deadband}$
Rate Of Change Alarm	<ol style="list-style-type: none"> 1. When ROC Mode is set to Off, no ROC alarm test occurs. 2. When ROC Mode is set to Hi, the system goes into alarm if the change in input value is $> \text{ROC Mag} + \text{deadband}$. The system goes out of alarm when the change in input value is $< \text{ROC Mag} - \text{deadband}$. 3. When ROC Mode is set to Low, the system goes into alarm if the change in input value is $< \text{ROC Mag} - \text{deadband}$. The system goes out of alarm when the change in input value is $> \text{ROC Mag} + \text{deadband}$. 4. The change in input value is computed in one of two ways, depending on the state of Fixed Interval. If Fixed Interval is checked, the change in input is calculated as the absolute value of the difference between the current value and the last value. If Fixed Interval is not checked, the change in input is calculated as the absolute value of the difference between the current value and the last value that caused a ROC Alarm to occur. Since no alarm has occurred on the start of recording, the first reading taken after the press of START recording (Or power up) is used as the basis to determine ROC alarm, once the unit goes into alarm, the alarm value becomes the basis for the next alarm.



Accumulator (Accum)

Inputs

Data – the data to accumulate

Enable – enable/disable the accumulation; when input is disconnected or input value is non-zero, accumulation is enabled

Outputs

TAccum – Trigger accumulation. Output when the running accumulation surpasses the threshold value.

Accum – Accumulation since last scheduled reset.

Trigger – Trigger. Output set to 1 when the running accumulation surpasses the threshold value.

PTotal – Previous total which is value of accumulation at scheduled reset.

Description

The Accum block is used to accumulate input data and to set outputs based on the current accumulation. This block is typically used as a part of a system to monitor and control a water sampler where blocks before the accumulator measure level and flow, compute discharge, and compute discharge*time. This block then accumulates the total flow and sets a trigger every time a selected amount of flow has been registered. The total flow is reset to 0 at a user set schedule, typically daily. The trigger typically connects to a pulse output block.

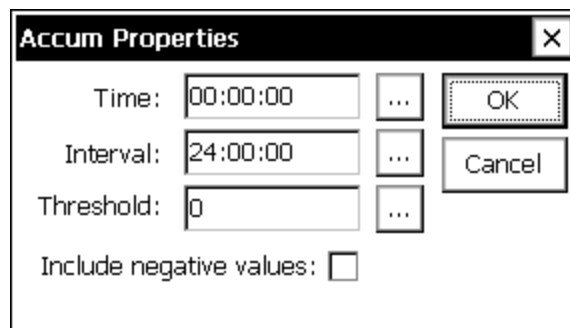

Use the *Time* and *Interval* properties to set the schedule at which the block resets the accumulation.

Use the *Threshold* property to specify the value of accumulation that, when reached, is a signal to set the trigger output to 1.

Check “Include negative values” to allow negative input values to be included in the accumulation. When not checked, negative input values are not included.



Average (Average)

Inputs

Input

Outputs

Average – Computes the mean average of the samples taken during the *Duration*.

Min – Outputs the minimum of the samples taken during the *Duration*.

Max – Outputs the maximum of the samples taken during the *Duration*.

STD – Computes the standard deviation of the samples taken during the *Duration*.

Count – Outputs the number of samples that were used to compute the average.

Description

The Average block is like a Measure block that can perform some common data processing functions related to averaging. The block can output the average (mean), maximum, minimum, standard deviation, or sample count (number of samples) from a series of data points sampled from a sensor.

The *Schedule Interval* indicates how often the Average block should sample a series of data points, process them, and output a value. The *Schedule Time* specifies the synchronization of when this should begin. The *Sample Interval* entry indicates how often the sensor should be sampled each time its scheduled to sample and the *Sample Duration* specifies for how long. To average continuously, the *Schedule Interval* should be set equal to the *Sample Duration*.

Note: *Sample Interval* may be set to milliseconds for sub-second sampling. For example, the value 00:00:00:500 would cause sampling to occur every 500 milliseconds. When specifying milliseconds, you must specify all three digits.

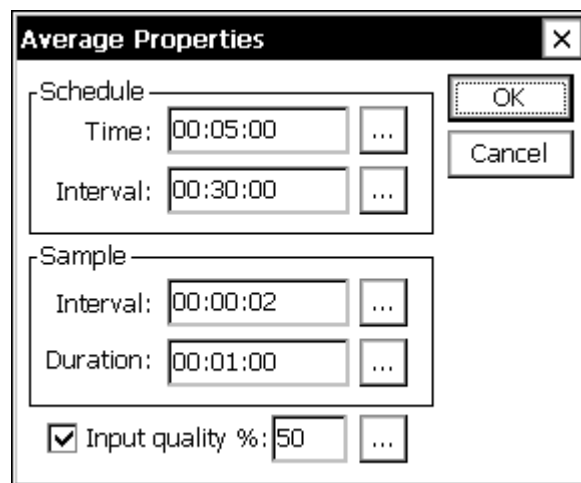

The example above shows an Average block that will perform it's averaging every 30 minutes, starting at an offset of 5 minutes from the hour. When averaging starts, samples will be taken

every 2 seconds, for a duration of 1 minute. At the time of the last sample, all the block's outputs (mean, min, max, etc.) are computed and are output. Note: **the timestamp assigned to all the output data is the time of the last sample**. In the example above, the timestamp for the averaging period started at 12:35:00 would be 12:35:58. **Note: To shift the timestamp so that it occurs at the end of the Sample Duration, increase the Schedule Time by one Sample Interval**. In the example above, this means set Time to 00:05:02, so that the timestamp occurs at the top of each minute, e.g., 12:36:00.

When *Input Quality %* is checked, output quality of the averaged result will be good only if the specified percentage of input samples have good quality. Note, the first average calculation after recording start may contain fewer samples than subsequent runs, since the calculation begins on the first sample interval that comes along after recording is started.



Bool (Boolean)

Inputs

X

Y

Outputs

Output

Description

The Boolean block is used to perform boolean operations on the two inputs, X and Y, and output the result in Output. Non-zero data values are considered “true”. A “true” output is assigned the value of 1.

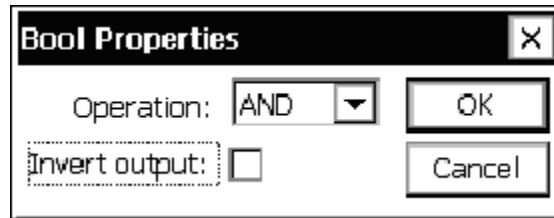

The *Operation* property can be set to one of “AND”, “OR”, or “XOR”. The table below defines the output given all the possible different inputs and operations.

Inputs		Output		
X	Y	AND	OR	XOR
true	true	true	true	false
true	false	false	true	true
false	true	false	true	true
false	false	false	false	false

When the *Invert Output* check box is selected, the outputs shown in the table are inverted.

Block Placement

The Boolean block should typically come BEFORE the measure (or average, or other “active” block) that executes it. This ensures the block operates on data from the same measurement frame, and avoids odd side effects that come from active blocks operating on split paths.



CS625 Water Content Reflectometer (CS625WCR)

Inputs

Frequency (Freq)

Soil Temperature C (SoilTemp)

Outputs

Volumetric Water Content (VWC)

Description

This block is used to compute Volumetric Water Content (VWC) using a CS625 Water Content Reflectometer sensor.

Wiring

The CS625 sensor's output should be wired to the input of the 6461-1285 frequency divider. The output of the divider should be connected to the input of the DIO module. A Frequency block is used to measure the input frequency. Set the sample period of the Freq block to 200mS.

The VWC calculation can be compensated for the current soil temperature, if desired. To do so, connect a block measuring the current soil temperature to the Soil Temperature input of the CS625WCR block. You may choose to use a Const block (providing a constant value), if soil temperature does not change enough to require additional compensation.

The diagram below shows a typical graphical setup of the CS625WCR block, compensated for soil temperature using a constant value entered into the Const block. To compensate for soil temperature using a measured value, replace the Const block with a sensor block configured to measure the current soil temperature. To assume a constant soil temperature of 20 C, do not connect any block to the Soil Temperature input.

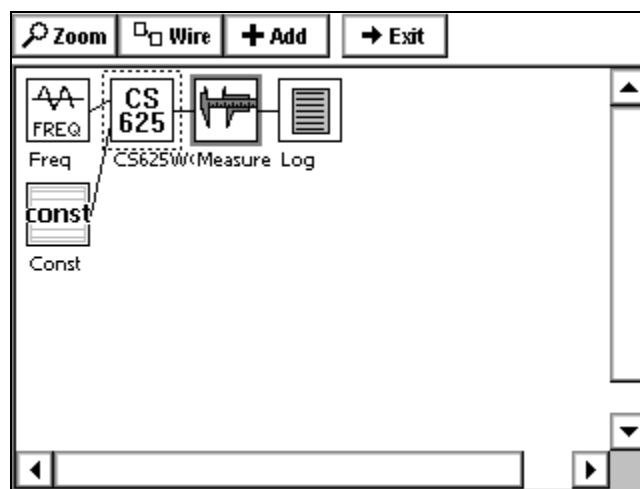

Properties

The CS625WCR block properties dialog is shown below:

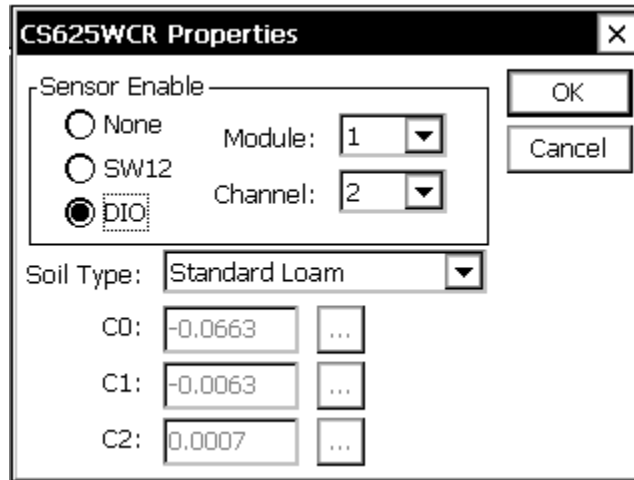

“Sensor Enable” controls how the sensor is enabled for measurement. If “None” is selected, the sensor is not enabled automatically (the sensor should be wired so it is always enabled, though this does result in more power consumption). When “SW12” is selected, the sensor enable should be wired to the SW BATT/12 output of the DIO module. When “DIO” is selected, the sensor enable should be wired to the DIO module and channel indicated in the “Module” and “Channel” properties.

Set “Soil Type” to the appropriate selection based on actual soil type. The coefficients C0, C1, and C2 change based on the soil type selected. Select a soil type of “User Defined” to enter your own coefficients.

Block Placement

The CS625WCR block should typically come BEFORE the measure (or average, or other “active” block) that executes it. This ensures the block operates on data from the same measurement frame, and avoids odd side effects that come from active blocks operating on split paths.



Dew Point (DewPt)

Inputs

temperature

humidity

Outputs

dew point

Description

This block computes dew point from temperature and humidity. The temperature input may have units of either Celsius or Fahrenheit (the units field of the incoming data is used to determine which is in effect). The humidity input is expected to be a percentage.

The dew point output is expressed in the same units as the incoming temperature.

The block has no user-set properties. Dew point is computed according to the “WMO Guide to Meteorological Instruments and Methods Observation” WMO-No.8 seventh edition, 2006.

Block Placement

The Dew Point block should typically come BEFORE the measure (or average, or other “active” block) that executes it. This ensures the block operates on data from the same measurement frame, and avoids odd side effects that come from active blocks operating on split paths.



DQAP (Quality-Controlled Average)

Inputs

Input

Outputs

Average – Computes the quality-controlled average (mean value) of the samples taken during the *Duration*.

STD – Computes the quality-controlled standard deviation of the samples taken during the *Duration*.

Count – Outputs the number of samples that were collected. (The number of samples used in the output average is the Count minus the Outliers)

Outliers – Outputs the number of samples that were greater than three standard deviations from the initial sample mean.

Description

The DQAP block is a special modification of the Average block. The Average block is a Measure block that can output the maximum, minimum, average, standard deviation, and sample count from a series of data points sampled from a sensor. The DQAP block also computes the average, and outputs it along with the standard deviation and sample count. The difference is in the way the average and standard deviation are computed.

The DQAP block makes use of statistical quality control theory to improve the accuracy of the reported mean and standard deviation. The improvement is obtained by computing the mean and standard deviation in two passes. In the first pass, the mean and standard deviation are determined by the usual process of simply using the collected samples “as is”. After the standard deviation is computed a second pass is made. In the second pass, before a sample is added to a sum, or squared and added to a sum of squares, it is compared to the mean plus or minus three standard deviations. Quality Control (QC) theory indicates that such samples are likely to be in error. An updated mean and standard deviation are computed using only the samples that pass the QC check.

The DQAP block is used to periodically take a number of samples from a sensor and then output the quality-controlled mean, standard deviation, sample count, and number of samples failing the QC check. For example, every half an hour, with a five minute offset, a sensor could be sampled every two seconds for thirty seconds and then the maximum value sampled outputted (see example below).

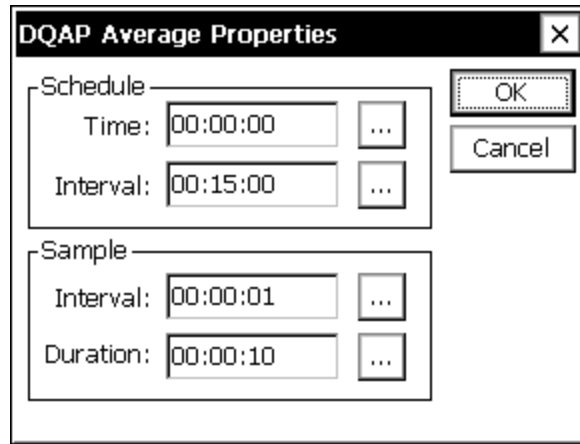

Specifically, the *Schedule Interval* indicates how often the DQAP block should sample a series of data points, process them, and output values. The *Schedule Time* specifies the synchronization of when this should begin. The *Sample Interval* entry indicates how often the sensor should be sampled each time its scheduled to sample and the *Sample Duration* specifies for how long. To average continuously, the *Schedule Interval* should be set equal to the *Sample Duration*.



Interpolate (Interpolate)

Inputs

InterIn

Outputs

InterOut

Description

The Interpolate block is used to apply a table lookup function to a data stream. This is useful in instances when applying a polynomial function would be too difficult. For values not in the entered table, the output is interpolated from adjoining table entries based on the selected *Method*. The outputted signal can be labeled with new units by clicking the *Units* button.

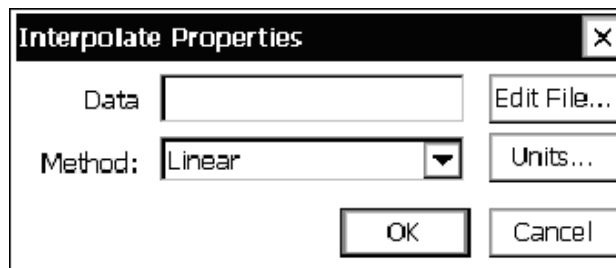

To load, edit or save the file to interpolate from, click the *Edit File...* button. The following window will come up:

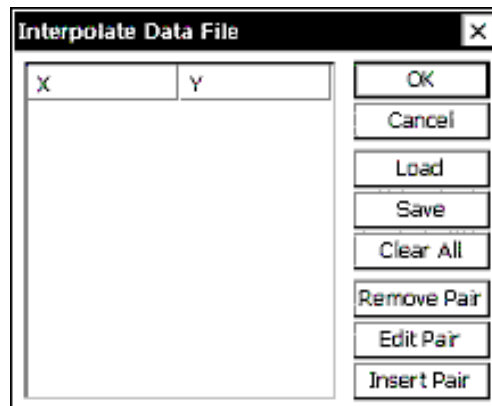

To start creating a new table, use *Insert Pair* to enter pairs of values. The values will automatically sort according to the values in the X column. Any XY pair can be edited or deleted by clicking on that pair and clicking *Edit Pair* or *Remove Pair*. To erase all the entries in the table, click *Clear All*. To save the file or load a previously saved file, click *Load* or *Save*.

For an interpolation table larger than a dozen entries or so, it might be faster to generate it on a PC (with Notepad, for example) and then upload it to the Xpert. Files should be created in

comma separate format, such as the example below. Note, the table should be sorted ascending on X:

10.22, 11.55

12.481, 20.999

15.0, 40.01

The extension of the file should be changed to .tbl before uploading.



Georgia Pacific Sampler (GPSmpl)

Inputs

DigIn

Outputs

DigOut

Description

This block samples the input (digital) at a user set interval. When the input transitions from low (0) to high (1), increment sampler count and save the time of the event. Then delay for n seconds (user set) and then force measurements of PH1, T1, PH2 and T2. PH1, PH2, T1 and T2 will be set up using standard blocks by tying a COMS TAG to the blocks that make the measurement and convert the value to the desired units. When the measurements are complete append the following record to \storage card\filename.csv in CSV format:

Date, time (edge detected), function, splcnt, ph1, t1, ph2, t2

Example:

08/27/02, 14:03:10, GPSmpl 1, 125, 5.62, 25.19, 9.73, 28.81

Use 2 right digits for ph1, t1, ph2 and t2.

If the file does not exist (because a new card has been inserted), create it. If there is a problem creating, opening, or writing to the file, send a warning message to the report.warning.

If the digital input stays at high (1) for more than 5 minutes, write a warning message to the report.warning.

Init splcnt to 0 when recording is turned on.

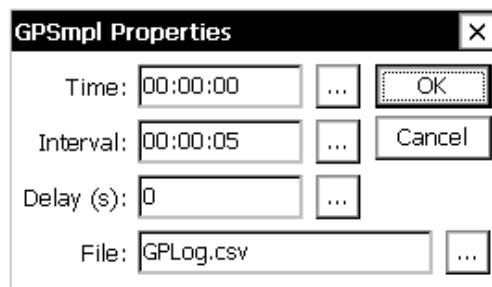



Measure (Measure)

Inputs

Input

Outputs

Output

Description

Measure blocks are used to create a sampling schedule for sensor blocks. The only time a Measure block (or similar) is not needed after a sensor block is when the sensor block is set to output data based on a specified change on the sensor input (Event mode).

Enter values for the *Time* and the *Interval*. The interval is how often the data from the sensor should be sampled. The time is a synchronization time (not an start time). In the example below, the sensor will be sampled every fifteen minutes, synchronized to the hour. If *Time* had been set to 00:01:00, the sensor would be sampled every fifteen minutes with a one minute offset – if sampling was started at 4:00pm, samples would be taken at 4:16p, 4:31p, 4:46p, etc.

Sensor blocks configured in Event mode do not need to be hooked-up to Measure blocks, but they can be if desired. Doing so will result in data being generated *either* because of a specified change in the sensor input *or* because the next scheduled sampling time has arrived.

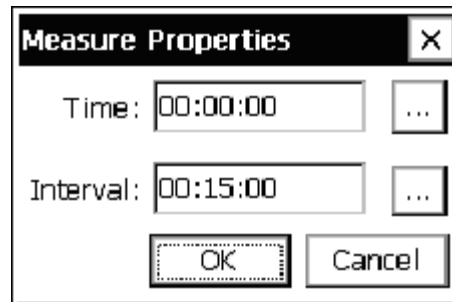

Min **Max** Minimum/Maximum (MinMax)

Inputs

Input

Outputs

Min

MinTime (Number of seconds into current day)

Count

Max

MaxTime (Number of seconds into current day)

RMaxVal

Description

This block outputs its data set at the time and interval defined by the user. The block examines the data received prior to its scheduled interval in order to determine its outputs: the maximum value received, the minimum value received, the time of maximum value, the time of minimum value, and the number of values received. The number from the time outputs is determined by the number of seconds since 00:00:00 of the current day (e.g. a time of 3600, would be 01:00:00).

The block also outputs RMaxVal, which is the value of an optional related item at the time the maximum occurred. This related item is a point in the setup tagged by a ComsTag block. The name of the tag must appear in the “Rel max val” field of the properties dialog. If no tag appears in this field, or if the name is invalid, then RMaxVal is output as 0.

This block is commonly placed after a *Measure* block that is sampling a sensor on a schedule, or directly after a sensor block setup in Event mode. The *Start Time* is an offset time. For example, if the start time below was set to 00:05:00, a measurement would happen at :20:00, :35:00, :50:00, 05:00, etc.

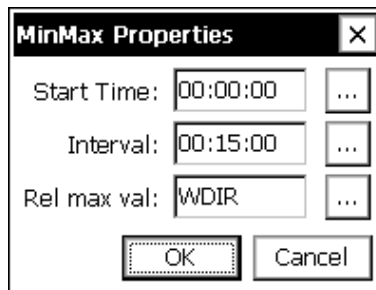



Moving Average (MovingAverage)

Inputs

Input

Outputs

Average

STD

Description

This block computes a moving average for the input value with each new sample. This differs from the normal Average block that computes the average only at the end of the scheduled interval. It can be used to compute an average speed over a two minute window with the average being updated every second. The screen that follows shows a 10 minute average with the samples being collected every 30 seconds and output of the average every 30 seconds.

When the block runs, the output data will be flagged as bad until $\frac{1}{2}$ of the required number of samples have been collected.

The checkbox labeled circular input can be used on wind direction sensors where the output is 0-360 degrees. With this box checked, the average will properly compute the average direction even when the sensor changes through 360 degrees.

The *Schedule* fields are used to control when the software reinitializes its computations. The process of re-initialization eliminates computational errors that would otherwise occur. In the following example, the moving average would reinitialize its computations every 12 hours synchronized to midnight.

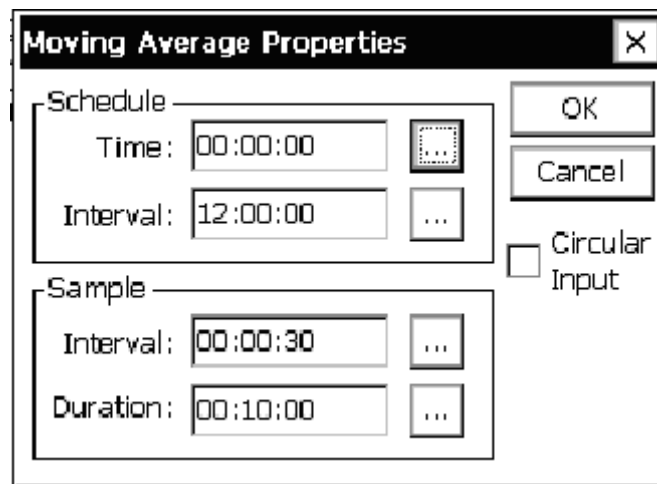



Polynomial (Poly)

Inputs

PolyIn

Outputs

PolyOut

Description

The Polynomial block is an extremely flexible, general-purpose processing block that can apply a polynomial function in any part of the Setup Diagram data stream. The orders of the desired equation – up to 5th order – are entered next to k_0 through k_5 . If the units to be outputted from this block are different from those of the signal that were inputted, those new units can be entered via *Units*.

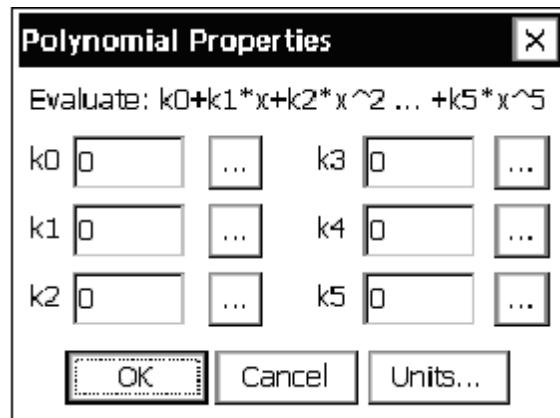

A good use of this block is to generating meaningful values from an unsupported sensor. For example, say there is a humidity sensor that outputs 0.5 to 2.5 volts for 0 to 100% relative humidity (different from the output of any sensors supported by the AT/RH sensor block). The following equation could be determined:

$$y = 50x - 25$$

which would convert the sensor voltage to a relative humidity value ranging from 0 to 100 that could be logged or transmitted.

To implement this in a Polynomial block, the 25 would be entered next to k_0 (for the 0th order of the equation) and the 50 entered next to k_1 (for the 1st order). Fields k_2 through k_5 would be left at zero since we are only implementing a first order equation. A general purpose VoltMeter or ADC sensor blocks would be used to input the sensor voltage into the system in this case.



PtCtrl (Point Control)

Inputs

Point

Enable 1

Enable 2

Outputs

Move +

Move -

Stop

Status

Description

The Point Control block is used to control the position of some device using a feedback control loop. The current position of the device is “wired” to the input *Point*. When the position of the device differs more than a user-defined amount, the outputs are set to attempt to bring the position of the device back to the desired point.

Point Control Properties

Offset: 00:00:00 ...

Interval: 00:05:00 ...

Pulse Time: 00:00:05:000 ...

Set Point: 10 ...

Deadband: 10 ...

Invert outputs:

Latched outputs:

OK Cancel

The control loop executes on a schedule set by the user. The *Offset* and *Interval* properties determine when and how often, respectively, the loop executes. Each is specified in seconds relative to a 24-hour clock.

Both enable inputs must be true for the control loop to execute. When *Enable 1* is false, the control loop skips execution and may execute at the next scheduled interval. However, when *Enable 2* is false, the control loop will no longer be scheduled until recording is restarted, regardless of its subsequent states. Also, when *Enable 2* is false, the *Status* output is set to false (it is set to true at all other times).

The user sets the desired device position by setting the *Set Point* property. The *Deadband* property defines the range of points that are considered to be within tolerance. Specifically, an input *Point* is in within tolerance (i.e. no attempt to reposition is made) when the difference between *Set Point* and input *Point* is less than or equal to *Deadband*.

Moves are accomplished by setting the *Move +*, *Move -*, and *Stop* outputs. These are boolean outputs typically wired to *BinOut* blocks in order to set the state of some hardware control line. When *Latched Outputs* is checked, the selected move line is set high for .25 seconds and then set low. After *Pulse Time* seconds elapses, the *Stop* output is set high for .25 seconds, and then set low.

When *Latched Outputs* is not checked, the selected move line stays high for the duration specified by *Pulse Time* before it is set low. The *Stop* output is not set in this case.

The *Invert Outputs* option is used to invert the sense of the control loop. The “normal” sense occurs when the box is not checked. In this case, *Move +* is selected when the input *Point* is **lower** than *Set Point* by more than *Deadband*. *Move -* is selected when the input *Point* is **higher** than *Set Point* by more than *Deadband*. When the *Invert Outputs* option is checked, *Move +* is selected instead of *Move -*, and vice versa.



Quality Control (QC)

Inputs

Input

Outputs

Output

Description

This block performs a range check on the input. If the range check fails, the output quality is set to bad. The input data is passed through to the output, otherwise.

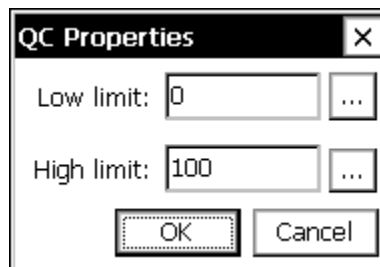

Set Point Control (SetPoint)

Inputs

Level

Outputs

Control

Description

This block compares the values coming in on its input with *Set Point* and outputs a 1 or 0 depending if the condition under *Trigger* is met. The *Deadband* allows hysteresis to be added so that the output will not keep change unless the input moves away from the *Set Point* by a meaningful amount.

This block implements a function similar to that of a household thermostat. For example, say we want to output a value of 1 if the input from an Air Temp sensor block crosses 40°C, except that we want there to be a deadband so that the output won't change from 0 to 1 until the input reaches 41°C and the output won't change from 1 to 0 until the output reaches 39°C. We would set *Set Point* to 40, *Deadband* to 1, and *Trigger* to *Above*.

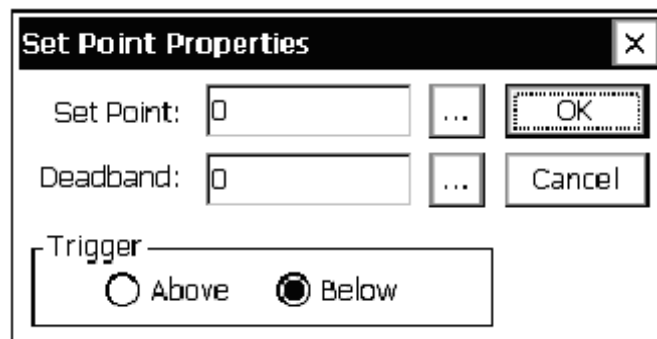

The image shows a dialog box titled "Set Point Properties" with a close button (X) in the top right corner. It contains three input fields: "Set Point:" with a value of 0, "Deadband:" with a value of 0, and "Trigger:" with two radio buttons, "Above" and "Below". The "Below" radio button is selected. To the right of the "Set Point:" and "Deadband:" fields are three buttons: an "OK" button, a "Cancel" button, and a button with three dots (...).



Solar Radiation Accumulator (SRAcc)

Inputs

SolRad

Outputs

Accumulation (Accum)

Sunshine (HrsSun)

Description

This block is designed to do the measurement and processing of data from a solar radiation sensor in order to compute the accumulated value and duration of sunshine. The user set properties of time, interval and sample interval (Smpl Intvl) control the execution of the block. Sample Interval sets how often the block will ask for data from the block connected to it. Typically, this block will be a solar radiation block but it can also be a voltage block or any other input\processing block that is not scheduled. The Time and Interval control when the accumulator is reset back to 0. With an interval of 24:00:00 and a time of 00:00:00, the accumulator would be reset every 24 hours at midnight. Hourly resets or resets at times other than midnight are also possible.

The basic computation of the block is:

$$\text{Accum} = \text{Accum} + \text{sample} * \text{smpl_intvl}/3600 \quad (\text{smpl_intvl in seconds})$$

This calculation is done every Smpl Intvl. If the sensor connected to the block has output units of W/m², the output of the block will be WHr/M². So, the block adds the dimension of Hr to the units of sensor it is connected to. The desired units are set by the Units property field.

The Acc Thrshld (Accumulator Threshold) sets the threshold for accumulating solar radiation data. If the input value is less than this threshold, the data will be ignored. Some sensors have a slightly negative or positive output value in low light conditions. The AccThrshld will ignore this data in the calculation.

The Sunshine calculation computes the amount of time that the input is greater than the hour threshold (hr thrshld). The calculation is simply:

If sample > hr_thrshld then

$$\text{HrAccum} = \text{HrAccum} + \text{smpl_intvl}/3600 \quad (\text{smpl_intvl in seconds})$$

Hr Thrshld is typically set to 120 (watts/m²) as set by the WMO. If the input is in other units, the threshold value will probably be different from 120.

SolRad Accumulator Properties [X]

Time: ...

Interval: ...

Smpl Intvl: ...

Acc Thrshld: ...

Hr Thrshld: ...

Units: ▼



Vector Average (VectAvg)

Inputs

Speed

Dir (Direction)

Outputs

Mean Speed Scalar – This is the scalar wind speed, not taking direction into account. The scalar average of 10mph for an hour and 20mph for an hour is 15mph, regardless of changing direction.

Mean Magnitude Unit – This is the vector average of the wind speed using a unit vector. The mean magnitude unit of 5mph at 0° for 1 hour and 100mph at 180° for 1 hours is 0mph (because two unit vector pointing opposite directions cancel when added with vector addition).

Mean Magnitude Wind – This is the vector average of the wind speed which takes direction into account. Here, the average of 10mph at 0° for 1 hour and 20mph at 180° for 1 hour is negative 5mph.

Mean Direction Unit – This is the wind direction (in degrees) not weighted for wind speed. Here, the average of 10mph at 0° with 20mph at 90° is 45°.

Mean Direction Wind – This is the wind direction (in degrees) weighted for wind speed. Here, the average of 10mph at 0° with 100mph at 90° is 84°.

STD Speed Scalar – This is the standard deviation of the scalar wind speed.

STD Direction Unit – This is the standard deviation of the direction unit.

STD Direction Wind – This is the standard deviation of the direction wind.

Min Speed Scalar – This is the minimum of the scalar wind speed.

Max Speed Scalar – This is the maximum of the scalar wind speed.

Max Direction – This is the direction taken at the time the max speed is detected.

Count – This is the number of samples that have been taken.

VsumX/n – This is the vectored average of the X direction components

VsumY/n – This is the vectored average of the Y direction components

sumX/n – This is the average of the X direction components

sumY/n – This is the average of the Y direction components

Description

The Vector Average block is a special version of the Average block that includes computations to make a vector average. The vector average is important to any sensor that has a circular discontinuity, such as a wind sensor with the crossover from 0 to 359 degrees. This block is, in fact, geared toward wind sensors, but could be used any time performing a vector average is

desired. Like the Average block, Vector Average itself requests samples from a sensor and thus does not require a Measure block to be used before it.

Vector Average has the same properties window as the Average block. See the description of Average for an explanation of the different fields:

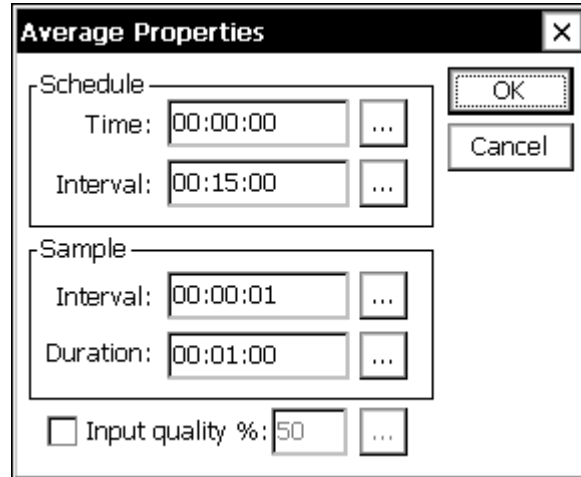

Vector Average has a large number of special outputs corresponding to all the vector computations it makes. To perform most of its computations, the Vector Average block requires signals on both its *Speed* and *Dir* inputs. These inputs correspond in a general sense to *magnitude* and *angle*, with the angle always specified in degrees.

When *Input Quality %* is checked, output quality of the averaged result will be good only if the specified percentage of input samples have good quality. Note, the first average calculation after recording start may contain fewer samples than subsequent runs, since the calculation begins on the first sample interval that comes along after recording is started. When *Input Quality %* is not checked, at least two good input samples are required for good output quality.



Wave Processor (WavProc)

Input

Input - SDI-12 output from Sutron Radar Stage or Distance values in feet

Outputs

T_1 - mean wave period in seconds

H_{m0} - Significant wave height in meters

H_{max} - Maximum wave height in meters

T_2 - Zero-up crossing period in seconds

T_p - Peak Wave period in seconds

S - Wave spectral estimates in m^2/Hz

F - frequency vector in Hz

In addition to the block outputs listed above, the block saves spectral and time-series data to CDIP formatted files, and offers an option to log the outputs in record format.

Description

The purpose of the block is to process the acquired Sutron Radar Water level data to determine the wave energy spectrum, wave height parameters. The data is collected once a second for 2048 seconds (34 minutes 8 seconds). The data is then processed using industry standard algorithms to produce the mean period, significant wave height, max wave height, zero-up crossing period, peak wave period and spectrum vector.

The processing includes the following steps:

1. Capture 2048 samples of radar data
2. Verify the data quality for any missing data. If there are holes in the data, fill them up using interpolation.
3. Apply detrending filter on the data and obtain final time-domain data.
4. Compute the ensemble-averaged spectral estimate using FFT techniques.
5. Compute the frequency vector.
6. Use wave estimator functions on the spectral estimates and frequency vectors to compute the final output values.

Configuring the WavProc Block

The following section describes how the Xpert WavProc block is set up for Wave height parameter estimation.

The WavProc block is typically connected to an SDI-12 sensor block configured to measure the Sutron Radar Level Recorder.

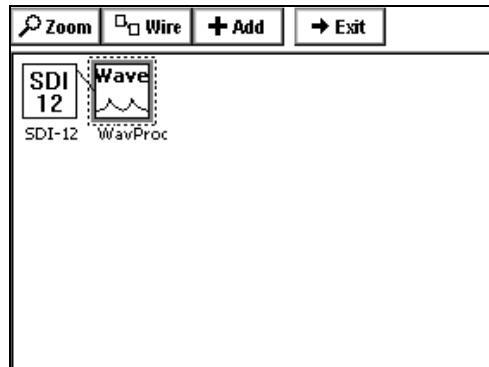

The acquisition characteristics of WavProc block are defined using the **WaveProc Properties** dialog, as seen in the illustration below. The Interval property defines how often to run, and typically should be no less than every hour (01:00:00). The Time property allows you to specify an offset for the interval. Note: sample duration is fixed to 2400 samples, or 34 minutes, 8 seconds.

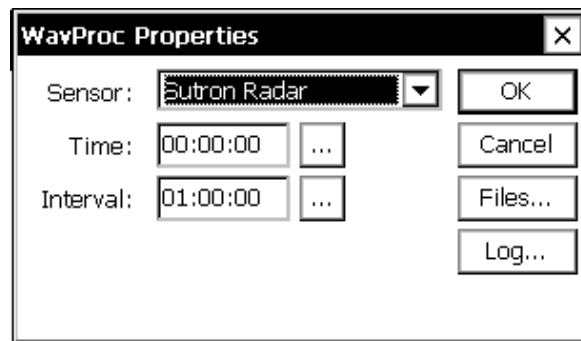

Use the **WavProc Files** dialog to specify where to save the Time-Domain sensor input data and Spectrum domain output data. An archive directory can be defined to host all the data files. Note: the most recent files are overwritten every measurement Interval, whereas the archive directory stores all files generated.

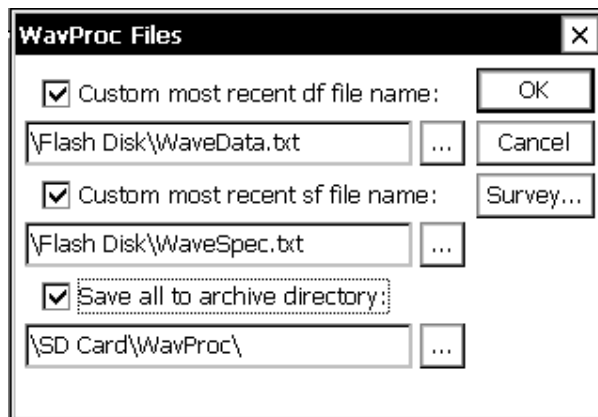

The **WavProc Survey** dialog allows you to define installation site-specific details. These details are included in the input and output data files automatically.

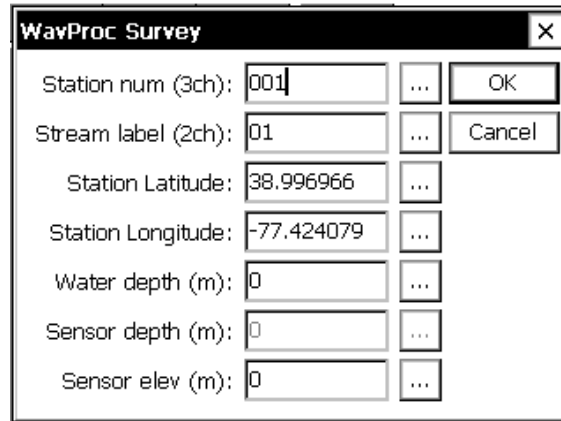

The **WavProc Log** dialog is used to configure record logging. When enabled, output data is logged in the following format:

DateTime,RecordID,T1,Hm0,Hmax,T2,Tp,CenterFrequency,BandWidth,Energy[1],Energy[2],...,Energy[16]



Radar configuration

The Sutron Radar should be configured for 1 second sampling. This can be achieved via the following SDI-12 commands:

```
Automeasure interval: XXS+1+1+1
Operating mode, Average Time and Right Digits: XXS+1+3+1+1+7
Sample Form period: XXS+1+23+1
```

To configure the Radar for 1 second sampling by RS-232, issue the following commands:

```
Automeasure interval = 00:00:01
Operating mode = 1
Average time = 1
Right Digits = 7
Sample form period = 1
```

Radar SDI-12 measurement

When using an SDI-12 block to acquire Radar data, use an M command to retrieve parameter 1. Be sure to set the correct Address.

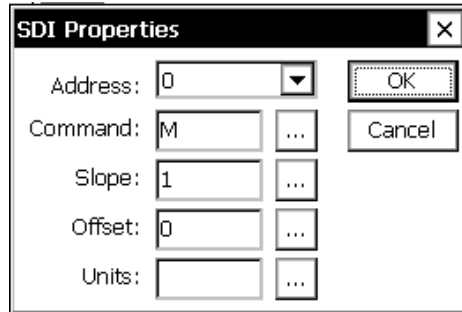

CDIP-Defined File Format

The block produces the following CDIP defined file format based input and output data files:

1. Spectral data (SP) file
2. Time-series data (df) file

The CDIP file format can be found here:

http://cdip.ucsd.edu/?nav=documents&sub=index&units=metric&tz=UTC&pub=public&map_stati=1,2,3&xitem=product#files.

Sample Spectral Data file

```
=====
File Name: sp07601199801091641      Analyzed(UTC): 2013 06/25 0103 hrs
Station Name: Sutron Sterling Office
Location: 35 12.50 N 120 51.60 W   Sensor Type: Sutron Radar Level Recorder
Water Depth(m): 23 MLLW      Sensor Depth(m): N/A      Sensor Elev(m): 23.0
Shore Normal(deg): N/A      Source File: df07600199801091708
Sample Length(s): 2048      Sample Rate(Hz): 1.0
Hs(m): 1.27 Tp(s): 15.38 Dp(deg): N/A Ta(s): 5.56
```

```
freq      Band      energy
  Hz      width    m*m/Hz
0.015625 0.03125 0.18
0.046875 0.03125 2.75
0.078125 0.03125 0.85
0.109375 0.03125 1.45
0.140625 0.03125 0.90
0.171875 0.03125 1.28
0.203125 0.03125 0.84
0.234375 0.03125 0.56
0.265625 0.03125 1.18
0.296875 0.03125 2.70
0.328125 0.03125 0.21
0.359375 0.03125 2.32
0.390625 0.03125 2.66
0.421875 0.03125 0.41
0.453125 0.03125 2.00
0.484375 0.03125 1.23
=====
```

Sample Time-series data file

```
=====
Name: SCRIPPS PIER                               Station: 07301
Channel description: SINGLE POINT
Deployment latitude: 32 52.000' N
Deployment longitude: 117 15.400' W
Water depth(cm):      680
Sensor elevation from sea floor(cm):      230
Data type: Water column (cm)
Gauge type: Sutron Radar Level Recorder
Sample rate(Hz): 1.000
Field software version: N/A
Field station type: N/A
Method of analysis: N/A
Radio modem: no
Energy basin processing: no
Surge filter processing: no
```

```
Number of records: 2048
Start time: 20020201000514 UTC
End time: 20020201011913 UTC
Sample length(hh:mm:ss): 00:34:08
```

```
-----
483.5  483.5  476.1  467.5  462.7  463.6  462.3  465.3
479.1  484.8  480.9  473.5  469.2  473.1  479.1  474.8
462.3  456.7  458.0  465.7  480.0  489.1  483.5  469.2
459.3  463.1  474.8  485.2  485.6  476.1  462.7  452.3
454.9  467.9  483.5  482.6  472.2  467.0  472.2  481.7
483.5  483.5  476.1  467.5  462.7  463.6  462.3  465.3
479.1  484.8  480.9  473.5  469.2  473.1  479.1  474.8
462.3  456.7  458.0  465.7  480.0  489.1  483.5  469.2
459.3  463.1  474.8  485.2  485.6  476.1  462.7  452.3
454.9  467.9  483.5  482.6  472.2  467.0  472.2  481.7
.....
.....
-----
```

XY Function (XYFunc)

Inputs

X

Y

Outputs

Z

Description

The XY Function block is for doing math between two inputs to produce an output value. The two inputs may be from a single block or from two different blocks. To use a constant in an equation (for example, to perform $x * 4$), use the output from a Constant sensor block as one of the inputs. The *Units* button should be used to tell the system what units to label the output values with. If x and y inputs have the same units, these units will be retained through to the output.

Block Placement

XYFunc output should be connected to the input of a measure (or other scheduled block). If you were to connect it after a measure, multiple entries would go into the log, and the most current data would not be used for both X and Y inputs. By placing the measure onto the output, the system will get input data at the same time from both inputs.

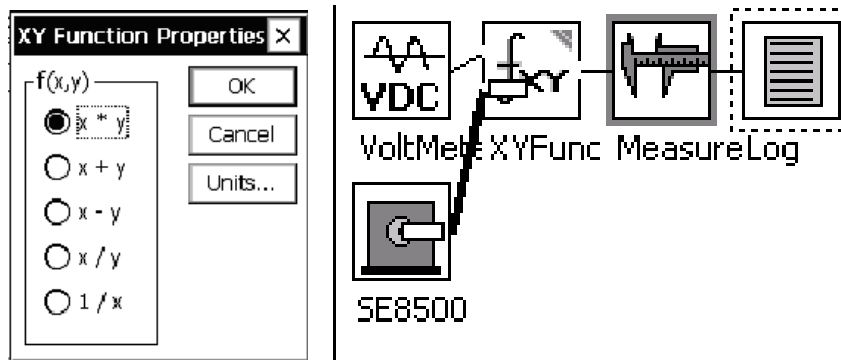

LOGGING BLOCKS

Log

Inputs

Input

Outputs

Output

Description

This block is used to funnel a data stream into a log file. Generally, one log block is needed for each signal of each sensor that needs to be logged. For example, if temperature and humidity from a AT/RH block needs to be logged, one log block is needed for each. The different log blocks in the system can log to the same log file, different log files, or anything in between.

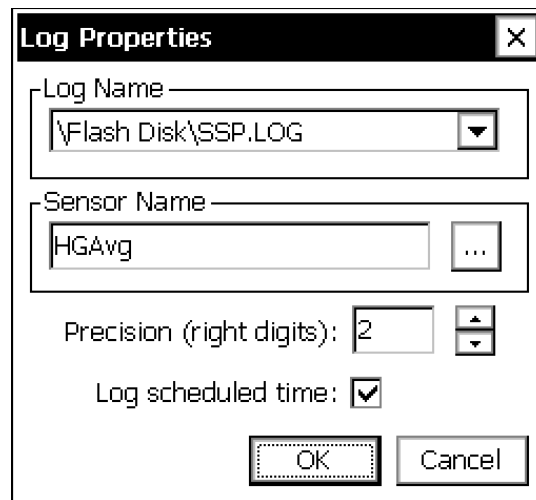

From the *Log Name* drop-down menu, select the log file the data is to be stored to. If the log you wish to use does not yet exist, select the “[New Log]” option from the drop-down list and the system will allow you to create a new log.

Sensor Name should be set such that it describes the source of the data. This name shows up in the *Sensor* column of the Log tab and is the only way to identify, for example, whether a temperature data point originated from an AT/RH, AirTemp, BP block.

Precision defines the number of places to the right of the decimal point that should be stored in the log. Blocks connected to the output of the log block will get a passed-through version of the data stream seen at the block input, except with the *precision* applied.

Log scheduled time determines the source of the timestamp that is given to the logged data. When checked, the data is timestamped with the time the data was scheduled to be measured. When not checked, the time the data is actually finally computed is used. This value may be

several seconds after the scheduled time, depending on how long it takes to measure and calculate the final value.

Logging with actual time instead of scheduled time can be useful when logging min and max values produced by the Average or MinMax blocks. When logging these values with “use scheduled time” unchecked, the timestamp of the data is the same as when the sample was taken that produced the min or max value, as opposed to the time the average, min, and max values are finally computed.

LogField

Inputs

Input

Outputs

Output

Description

The LogField block works in tandem with the LogRec block to enable you to build a record of data from several fields to add to a log. The LogField block defines the characteristics of one of the fields within the record.

The following shows the Log Field Properties dialog used to configure the Log Field block.

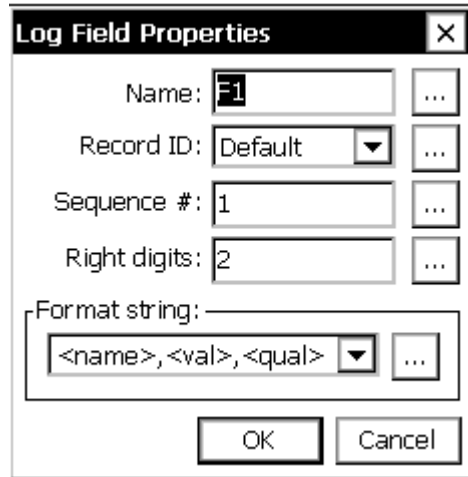

The *Name* property simply gives the field a name that can be included in the formatted output, if desired. The name isn't used for any other purpose. The system creates a default name of "Fx", where "x" is an integer representing the number of fields created so far. Typically, you'll want to name the field something more relevant to its purpose, e.g., "Temp" or "Level", etc.

Record ID identifies to which LogRec block this field belongs. The drop-down list allows you to select from all LogRec blocks in the system so far. Or, you can type the name of a LogRec block you intend to create by clicking on the "..." button next to the drop-down. Note that LogField blocks are attached to LogRec blocks by way of Record ID. Hence, if there are two LogRec blocks in the system with the same name, you will see two entries for the name in the drop down list, but selecting either one adds the field to both records.

The *Sequence #* property defines the order in which this field will appear in the logged record. When you press the "..." change button, the system initializes the change dialog with the next available sequence number for the current Record ID.

Right Digits specifies the number of places to the right of the decimal point the value logged should have. Note that this applies only to numeric data. If the value being logged is non-numeric (a string), this property is ignored.

The *Format string* property defines what the formatted output will look like in the logged record. The drop-down list provides several different formats to choose from, however, you can specify a custom format string by clicking on the “...” change button next to the list.

The format string combines formatting “tags” with literal characters. Formatting tags are always of the format, “<tag-name>”. The format tags currently supported are “<name>”, “<val>”, “<units>”, and “<qual>”. Whenever the name tag is encountered during formatting, it is replaced with the name of the field. Similarly, the val tag is replaced with the field value, and the qual tag is replaced with the data’s quality flag.

For example, given a field named “Temp” with value (after right digit application) “21.55”, units of “C”, and “good” quality...

Format string	Result
<name>,<val>,<units>,<qual>	Temp,21.55,C,G
<name>,<val>,<qual>	Temp,21.55,G
<name> <val>	Temp 21.55
“<val> <units>”	“21.55 C”
<val>	21.55



Inputs

Input

Outputs

Output

Description

The LogRec block works in tandem with the LogField block to enable you to build a record of data from several fields to add to a log. The LogRec block defines the characteristics of the record. In addition to disk based logging, the LogRec block also supports FTP and Socket logging. FTP logging appends the data to a text file on a FTP Server, while Socket logging creates a TCP/IP server that will log the data to any client that connects to it.

The following shows the Log Record Properties dialog used to configure the LogRec block.

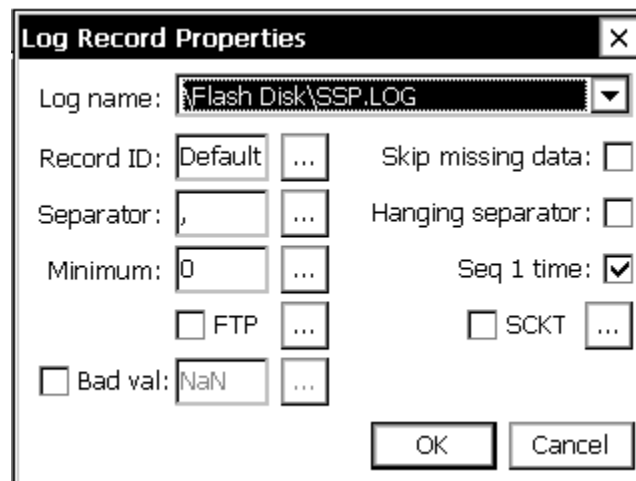

The *Log Name* property identifies to which log the record should be added. The drop down list contains a list of all logs in the system, plus an additional entry that allows you to add a new log. <None> may be selected to disable storing the data record to log files.

Record ID identifies the name of the record. The name given appears as a selection in all LogField block property dialogs, and is used to identify which fields belong to this record. In addition, Record ID is used to name the record entry in the log.

The *Separator* property defines the string to use in between each field when formatting the record for output to the log.

The *Minimum* property specifies the minimum number of fields that must be formatted into the record before the record will actually be logged.

The *Skip missing data* property determines whether to skip fields whose data has not been updated since the last time the record was formatted and logged. “Skipping” a field means

skipping it entirely, meaning the formatted record won't contain even a placeholder for the data. When this property is not checked, all fields are included in the logged entry, regardless of when the data was last updated. In this latter case, it's important to make sure all field and record measurement schedules are set up to ensure that field data measurements are complete when the record is computed and logged.

Hanging separator determines whether to terminate the formatted output with a separator character. For example, if the property is checked, and the separator character is a comma (','), the logged data will have a comma at its end, as well as between all fields. If the property is not checked, no comma will appear at the end of the logged data. This property is most useful in ensuring the output is compatible with automatic parsing logic used after the log is downloaded.

The *Seq 1 time* property determines what timestamp will be given to the log entry. If the property is checked, the timestamp given is the time of the data in the first formatted field (typically, the field having Sequence # = 1). If the property is not checked, the timestamp given is the time the LogRec block runs (which is typically determined by the schedule of the measure block connected to the LogRec block's output).

When *Bad val* is checked, the value specified is logged for data whose quality is bad or undefined, as would be the case for example when an I/O error occurs when taking the measurement. Any value can be entered, but note, when "NaN" is used, SSP time-tag data polls will include a "nil" for the parameter, per the protocol specification.

When *FTP* is checked, logged data will be appended to a file on a FTP Server. To select the details press [...] and the FTP Logging Properties dialog will be displayed:

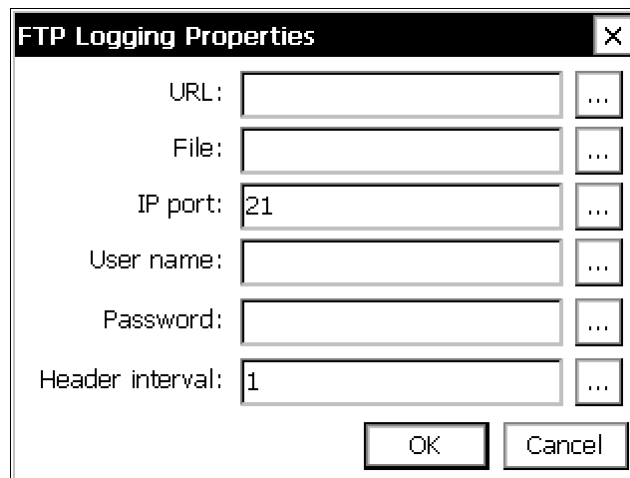

URL selects the IP address of the FTP Server and may optionally contain a URL if DNS is available.

File selects the name of the file to append the log records, and may contain a path (ex: "/home/loggeddata.csv"). Please note that the file paths on an FTP server typically use the Unix syntax and hence use the forward slash ("/") character as shown in the example.

IP port selects the port number of the FTP Server and is typically 21.

User name provides the user name for authenticating with the FTP Server. Only simple authentication is supported.

Password provides the password used for authenticating with the FTP Server.

Header interval defines how often a header is output in a separate line before the data record (0 for never, 1 for every time, 2 for ever other time, 3 for every third time, etc). The header describes the contents of the data record. As long as the Header Interval is not 0, a new header will be appended after recording has been turned ON to ensure any changes to the setup are reported.

When *SCKT* is checked, a TCP/IP server will be created that will report the record data to any client that connects to it. To select the details press [...] and the Socket Logging Properties dialog will be displayed:

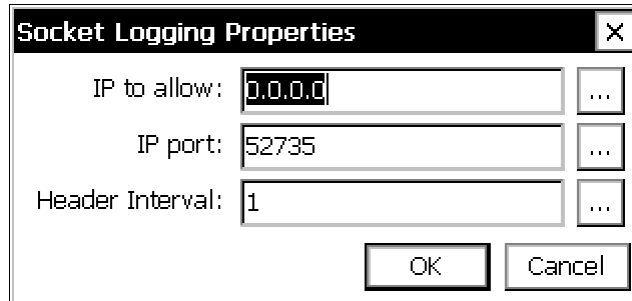

IP to allow defaults to 0.0.0.0 which allows any client to connect to the server, any other value will restrict connections to that IP (a URL may not be used in this field).

IP port selects the TCP port to be used for connecting to the server, and must not conflict with other TCP ports used by the system (the default value is 52735).

Header interval defines how often a header is output in a separate line before the data record (0 for never, 1 for every time, 2 for ever other time, 3 for every third time, etc). The header describes the contents of the data record. As long as the Header Interval is not 0, a new header will be appended after recording has been turned ON to ensure any changes to the setup are reported.



WebLog

Inputs

Input

Outputs

Output

Description

The WebLog block allows you to place the value connected to the input on the Xpert web page. The Xpert web page is a single page of HTML containing the names and values of interest in the logger. The Sensor Name field sets the name that will be used on the web page and the precision controls how to display the value.

When “Log scheduled time” is checked, the scheduled time of the data value is used as the timestamp of the data shown on the webpage. When “Log scheduled time” is not checked, the actual time the value is computed is displayed (normally, these times are the same; they may differ when measurement delays occur due to loading and/or other factors).

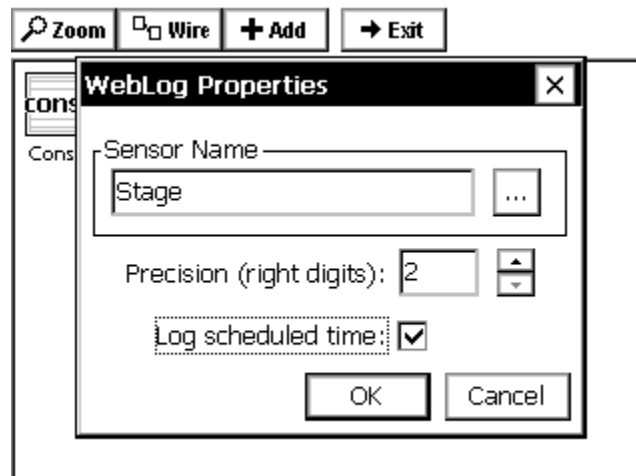

TELEMETRY BLOCKS



Coms Tag

Inputs

Data

Outputs

Data

Description

This block identifies (or “tags”) data to be shown on the Data tab . If the block is connected to an Alarm block, the Data tab will show alarm information for the tagged data point.

The Coms Tag block also “tags” information to be included in SSP communications messages. When another station requests “current data”, “alarm data”, “get tag”, “send tag”, or “eval tag” (these are common SSP requests) the Xpert provides the data from the Coms tags. Therefore, you control the data that is included in the responses to these data requests by attaching a Coms tag to the desired data. NOTE: This "tag" is case-sensitive; therefore, it should always be entered in UPPERCASE letters to avoid confusion.

The Prefix and Suffix phrases are only used in speech/voice modem messages. If you do not see choices for the prefix and suffix, the speech files have not been loaded into your Xpert.

The Right Digits property controls the precision of the tagged data, but only when the check box is checked.

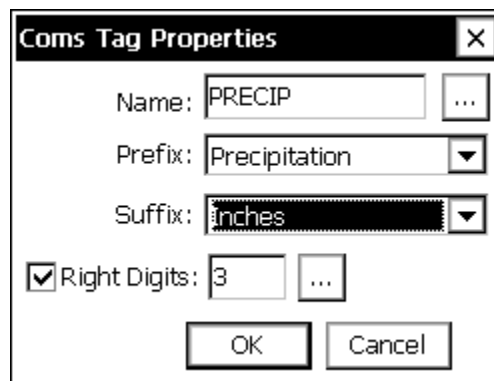

Note: In order to take live measurements of the sensors with which the Coms Tag is inline, there must be no “active” blocks between the Coms Tag and the inline sensor block. Generally speaking, this means the Coms Tag must be connected after the sensor block, and **before** any Measure, Average, or other active block (an “active” block is one that initiates a measurement, and typically has a darkened border in the graphical setup). If the Coms Tag is connected after the active block, it will not be able to retrieve live data.



Random Group (RndGroup)

Inputs

Trigger

Outputs

Output (pass-through)

Description

This block defines the alarm conditions for a random transmission group. Its input is typically connected to a sensor that the system is measuring. Each time the sensor is measured and the data is passed to the random group block, the block will check the value for the different type of alarms and trigger an alarm or go out of alarm as determined by the data.

If more than one RndGroup block is used to define a trigger point for the same group, each RndGroup block must have the same DTime, DInter, and Label values. If they differ, the system issues a warning when the setup is saved.

Group lets you define which random group you are defining the alarm properties for. Label defines the string that will be added to the random transmission to identify the group. Typically, label is a single character such as "2" or "3" (e.g., group number). This field can be any length, but only the first 3 characters are used in the transmit message.

A line is placed into the sensors tab for each random group block in the setup. This line is provided as a way to see the current alarm status of the different groups. If a random group line is selected and measured, or if "Measure All" is pressed, then the random group(s) will pull and evaluate their data. This can result in one or both of the following conditions:

If the random group were placed into the setup after a log block, this would send the data pulled into the log, with the time stamp of when it was measured. If it is desired to not have this data go into the log, the random group should be placed before the log block.

This will also evaluate alarm data before the next measurement. This would be useful when a user is at a site and knows that an event occurred that should trigger an alarm transmission, before the next measurement interval.

Time and Interval

Time and Interval are used to determine what data is transmitted from the data collected by the random parameter blocks. A time of 00:00:00 and interval of 00:15:00 tells the system to consider data with times 00:00:00, 00:15:00 ... 23:45:00 when it is time to format and transmit. This is useful for the situation where the block is connected to an output that is providing data more frequently than it is being transmitted. It also allows the formatter to identify data that is missing when it comes time to transmit it.

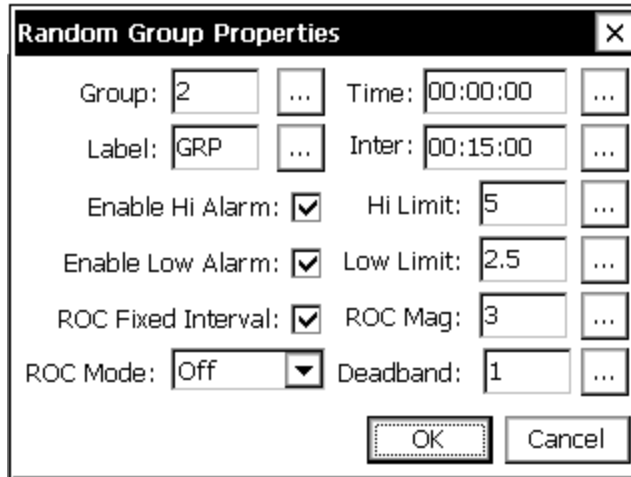

The different alarms are:

Hi Alarm	System goes into alarm if the input value is $> \text{Hi Limit} + \text{deadband}$
	System goes out of alarm if the input value is $< \text{Hi Limit} - \text{deadband}$
Low Alarm	System goes into alarm if the input value is $< \text{Low Limit} - \text{deadband}$
	System goes out of alarm if the input value is $> \text{Low Limit} + \text{deadband}$
ROC Alarm	<ol style="list-style-type: none"> 1. When ROC Mode is set to Off, no ROC alarm test occurs. 2. When ROC Mode is set to Hi, the system goes into alarm if the change in input value is $> \text{ROC Mag} + \text{deadband}$. The system goes out of alarm when the change in input value is $< \text{ROC Mag} - \text{deadband}$. 3. When ROC Mode is set to Low, the system goes into alarm if the change in input value is $< \text{ROC Mag} - \text{deadband}$. The system goes out of alarm when the change in input value is $> \text{ROC Mag} + \text{deadband}$. 4. The change in input value is computed in one of two ways, depending on the state of Fixed Interval. If Fixed Interval is checked, the change in input is calculated as the absolute value of the difference between the current value and the last value. If Fixed Interval is not checked, the change in input is calculated as the absolute value of the difference between the current value and the last value that caused a ROC Alarm to occur.



LAN Telemetry Tag

Inputs

Input (the value to transmit)

Outputs

Output (pass-through)

Description

This block is used to select data to include in a self-timed or alarm transmission over the LAN. The properties specify what data to include in the transmission, how many data values to include, and the order of the data.

NOTE: The settings for the transmission format are in the Setup tab under LAN Settings – Transmit. From there, you can select one of the allowed formats. The transmission routines use this selected format and the information in this block to properly format the data.

If the selected format is “BUFR”, the settings differ slightly than what is shown and described here. Please see [BUFR](#), later in this document, for details.

Label

The Label field has multiple uses depending on the transmission format selected. Please see **Appendix H, Transmission Formats** for details on how the label is used in various transmission formats.

TxContent, DataInterval, DataTime, NumValues

These properties define what data to include in the transmission. See the following table for details:

Tx Content	Description of data to transmit
All	All the data measured since the last

		transmission (or up to Num Values for interleaved formats), will be transmitted
Individual		Individual values are selected for transmission based on timestamp
	Data Interval	The time interval between readings. For example, “01:00:00” means “hourly data”
	Data Time	The time, or offset into the interval, of the data to include. For example, “00:15:00” means “include data measured on a 15 minute offset”
	Num Values	Number of values for each data item to include in the transmission. Enabled only for non-interleaved transmission formats. When interleaved, the Num Values setting associated with the telemetry device is used.
Last		Only the last measured value will be transmitted (or the last Num Values, for interleaved formats)
Exclude		Exclude this item from transmission

Sequence

This property determines the order of the data item within the transmission.

Right Digits

This property determines the number of right digits to include in the transmission.

The “Log...” Button

The “Log...” button opens a dialog used to select the backing log containing the data for transmission.

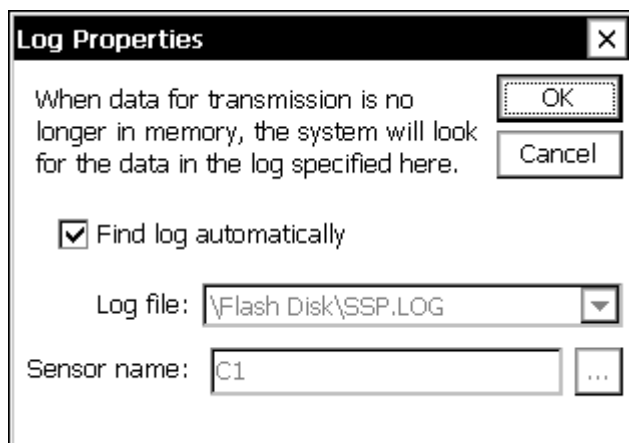

The system normally stores transmission data in memory, and only resorts to searching the log when the data is not found there (e.g., due to power-loss). The system normally selects the

backing log automatically. If the automatic selection is incorrect, uncheck “Find log automatically” and specify the log manually.

Note: The system is unable to use log records as a backing log for transmission data (i.e., data logged using the LogRec and LogField blocks).



Random Parameter (Random)

Inputs

Input

Outputs

Output (pass-through)

Description

This block allows you to include the data from the input in a random satellite transmission. It is most commonly linked to the output of a log block but can also be linked to the output of a measure or average. The Random Properties dialog is used to enable random transmissions and define the normal and alarm rate for the transmissions. This block lets you assign the sensor to one of the 8 different random groups (groups 2 .. 9). Each group must have a separate trigger sensor defined by the Random Group block. When the trigger sensor goes into alarm (as defined by the Random Group block, above), the Xpert will make a random transmission of all the sensors assigned to that group. At other times, the Xpert will transmit the data for the different groups according to the setup in the Setup tab. A sensor may be in as many groups as desired.

Along with assigning the sensor to groups, this dialog sets the sequence of the sensor (in the transmission) and the number of values to include in the transmission (BIN-NONINT format). The number of values cannot be set in this dialog if the format is set to BIN-INT in the Satlink settings under the Setup tab.

Random Properties

Group Membership

Group 2 Group 5 Group 8
 Group 3 Group 6 Group 9
 Group 4 Group 7

Sequence: ...

Num Vals: ...

Label: ...

OK
Cancel



Self-Timed Parameter (SelfTimed)

Inputs

Input (the value to transmit)

Outputs

Output (pass-through)

Description

This block selects data to include in a self-timed satellite transmission. The properties specify what data to include in the transmission, how many data values to include, and the order of the data.

NOTE: The settings for the transmission format are in the Setup tab under Satlink/Self-Timed. From there, you can select one of the allowed formats including SHEF, SHEFFIX, BIN-INT, BIN-NONINT, NOS, and INSAT. The transmission routines use this selected format and the information in this block to properly format the data.

If the selected format is “BUFR”, the settings differ slightly than what is shown and described here. Please see [BUFR](#), later in this document, for details.

Label:	AT	...	OK
Data Time:	00:00:00	...	Cancel
Data Interval:	00:01:00	...	Log...
Num Values:	8	...	
Sequence:	1	...	
Use calc time:	<input type="checkbox"/>		

Label

The Label field has multiple uses depending on the transmission format selected. Please see **Appendix H, Transmission Formats** for details on how the label is used in various transmission formats.

Data Time and Interval

Data Time and Data Interval define which data values coming into the block should be stored for transmission.

For example, a Data Time of 00:00:00 and a Data Interval of 00:15:00 causes the block to store any data coming into the block whose timestamp matches those values, i.e., any timestamp in the set 00:00:00, 00:15:00 ... 23:45:00. Similarly, a Data Time of 00:02:59 and Data Interval of

00:06:00 will cause the block to store data whose timestamp falls in the set: 00:02:59, 00:08:59 ... 00:56:59. Note: When Data Time and Data Interval are both 00:00:00, all data coming into the block is stored for transmission, regardless of timestamp.

Num Values

The SHEF, SHEFFIX, BIN-NONINT, and INSAT formats use Num Values to set the number of values of this sensor to include in the transmission.

NOTE: Setting Num Values in the Setup tab first will provide the default value used when adding new SelfTimed blocks to the setup. This can help reduce the number of edits you must make when creating a setup where the Num Values for each SelfTimed block is the same.

The BIN-INT and ASCII Column formats only uses Num Values entered in the Setup tab. The value in the SelfTimed block cannot be changed. The NOS format does not use Num Values at all.

When INSAT is the selected format, then when Num Values is greater than 1, previous data is placed into the positions of subsequent ids. For example, when sensor id 2 has a Num Values of 3, the most recent value is transmitted as id 2, the next most recent value is transmitted as id 3, and the next most recent value is transmitted as id 4. Note how this precludes having sensor ids 3 and 4 defined in the setup. If a multiple-position id (e.g., R356) is encountered with Num Values greater than 1, the values are repeated only within the first frame of the message, and only so many times as to ensure complete entries (an orphaned integer entry will not occur).

Sequence

Sequence is used by the SHEF, SHEFFIX, BIN-INT, and BIN-NONINT formats to define the order of the sensors in the message. It is not used by the NOS and INSAT formats as these have a fixed sequence.

Use Calc Time

The “Use Calc Time” checkbox is used to specify that the input data’s actual time of calculation should be used for all formatting considerations, and not the data’s scheduled time. This option is available only when SHEF or SHEFFIX is the current format.

Using the calculated time is useful when the input data is a min or max point from the min-max block. When this is the case, the data point will be collected regardless of the offset and interval property values, and will be formatted with its own label, offset, and interval fields, despite the value of num values. This allows the timestamp of the incoming data to be determined at runtime, and for it to be formatted with an accurate offset field.

The “Log...” Button

The “Log...” button opens a dialog used to select the backing log containing the data for transmission.

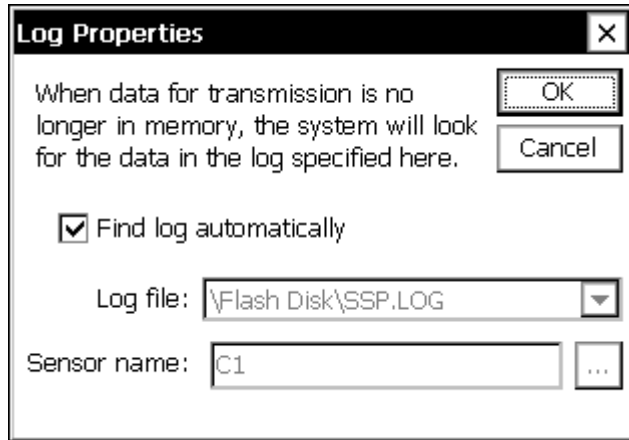

The system normally stores transmission data in memory, and only resorts to searching the log when the data is not found there (e.g., due to power-loss). The system normally selects the backing log automatically. If the automatic selection is incorrect, uncheck “Find log automatically” and specify the log manually.

Note: The system is unable to use log records as a backing log for transmission data (i.e., data logged using the LogRec and LogField blocks).

OUTPUT BLOCKS



Binary Out (BinOut)

Inputs

BinIn

Outputs

BinOut

Description

This block is used to control one Digital I/O Module channel's output switch. The switch is either activated (on) or inactive (off). When activated, the switch connects 100 ohms between the channel I/O pin and ground. To configure the block, select the module number, the channel number, and whether or not the output logic should be inverted. The reset/power up state of the digital I/O module is that all the output switches are off. The output switch will also turn off anytime that recording is turned off. Note: Do not use channel 1 or channel 8 for an output.

For more on how Digital I/O Module channels can be used as outputs, see the Appendix C: I/O Modules.

Non-inverted Output States are:

Binary 1 (switch on) = ground

Binary 0 (switch off) = Pull-up to internal +V (depends on channel, see appendix for detailed specs)

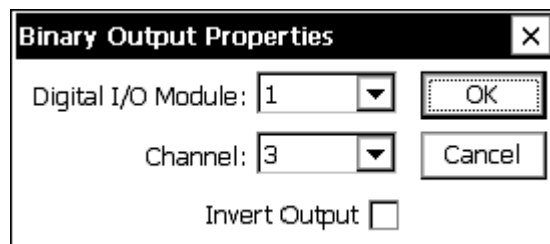



Pulse Out (PulseOut)

Inputs

In

Outputs

Out

Description

This block is used to generate a pulse on a digital output for a short duration defined by Pulse time. A new pulse will be output each time the block is executed with an input value that is non-zero. The normal state of the digital output pulse will be OFF, ON, OFF. If invert is selected, the pulse will be ON, OFF, ON. Where ON = input grounded, OFF = Pull-up to internal +V (depends on channel, see appendix for detailed specs). Note: any pulse in progress when recording is stopped is terminated, and so may end prematurely.

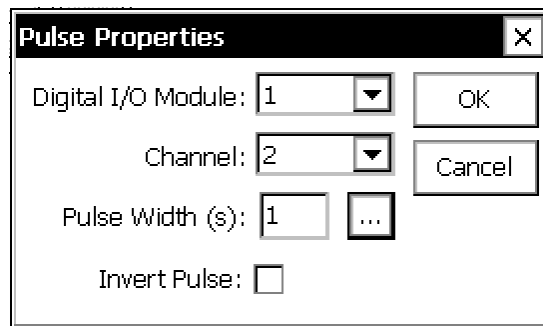

Use the Digital I/O Module and Channel properties to set the module and channel. Do not use channel 1 or channel 8. Set the width of the desired pulse in the Pulse Width property, fractional seconds are accepted (e.g. 0.1).

NOTE: If using a digital io module with version 2.03 or earlier, DO NOT use pulses of 1 second or less (e.g. use 1.1 or more). Starting with 2.5, more accurate pulses are used via the modules built-in pulse function. In version 2.03 and earlier, this does not work as it corrupts other channels.



Send Tag

Inputs

Data

Outputs

<none>

Description

This block will send the current data in the block to another station using Sutron Standard Protocol (SSP) communications. The properties for the block specify the port to use for the communications and the path or station name. The port can be specified only if you have first used the Setup tab Coms (SSP/CL) entry to define some communications ports. The path can be a simple station name or a station with full path information included (such as `\patha\pathb\stationx`). When the Port selection is “TCP/IP”, enter the URL to the destination. The Tag property must match the name specified in a COMS Tag in the named station.

For example, Station 1 is measuring water level and wants to send the water level to Station 2. Add a SendTag block after the measure of the water level in Station 1. Set the Name to WaterLevel and also set the port and path for the link between the two stations. In Station 2, add a COMS Tag and set the name property to WaterLevel. Now, whenever the SendTag block runs, the code will send the water level to the COMS tag block in Station 2.

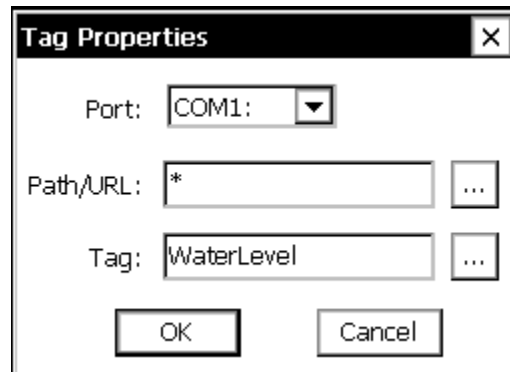

MISCELLANEOUS BLOCKS



Display (Display)

Inputs

Input

Outputs

Output

Description

The Display block is used select data that gets displayed on the 9210's I2C Display. The data displayed is the last measured value for the block connected to the display block. The data is displayed at the requested precision (right digits) with the selected Label.

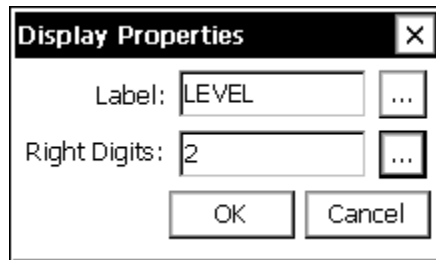



Field Variable (FieldVar)

Inputs

Input

Outputs

Output (pass-through)

Description

The FieldVar block is used to “tag” properties in the setup so that these properties can be changed in the same way as other system “tags” (ComsTags, Basic tags, etc.). System tags can be changed via the Data tab, via a Basic program, via the “set” command, and via SSP command. Note that changing the value of a property is reserved for users having setup access privileges.

The FieldVar block has one input and one output. Connect the output of the target block to the FieldVar input. Viewing the properties of the FieldVar block shows a list of changeable properties of the target block. Below is an example of the FieldVar properties screen when hooked-up to a Measure block.

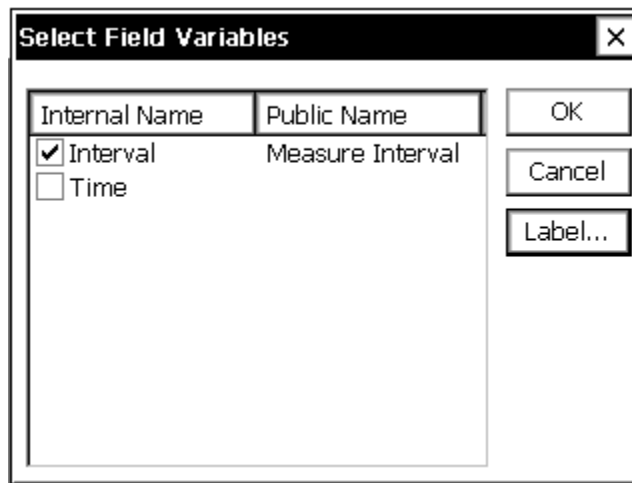

Put a check next to the property you want to tag. Checked properties must have unique *Public Names*. This name defaults to the Internal Name when OK is pressed. The *Public Name* for a property is changed by clicking the property name and then clicking *Label...*

Below is an example of how the Data tab looks when a Measure block has been connected to a FieldVar block with Interval checked and assigned the public name of “Measure Interval”.

Appendix B: Updating the Firmware

UPDATING THE FIRMWARE

From time to time, Sutron will make available new versions of firmware, in order to introduce new features and fix the occasional bug. These updates are typically made available as downloads on the Sutron website (www.sutron.com/downloads/software.htm).

If your system is performing up to your expectations, you may not want to update your firmware, since there is always some risk of introducing a new problem into the system. If you are unsure whether to update your system, and would like to know more about the contents of a particular firmware update (what it adds and what it fixes), contact Sutron Customer Service and request the engineering bulletin for the update.

When new firmware is released, the user upgrades in one of two ways:

Serial/Ethernet Upgrade: Serial cable connected to COM1 on the Xlite and, optionally, ethernet cable connected to DHCP-enabled network.

Storage Card Upgrade: SD or USB flash drive (does not upgrade loader, nor micro monitor).

WHEN UPGRADING TO v3.8 OR HIGHER FROM v3.7 OR LOWER, YOU MUST UPGRADE THE LOADER!!! SEE, "Upgrade the Boot Loader", BELOW. AFTER UPGRADING THE LOADER, UPGRADE THE APPLICATION AND KERNEL.

DO NOT DOWNGRADE TO v3.7 FROM A VERSION HIGHER THAN v3.7 WITHOUT OFFLOADING YOUR DATA FIRST! DOWNGRADING TO v3.7 FROM A HIGHER VERSION WILL RESULT IN A LOSS OF DATA ON FLASH DISK!

SD CARDS ARE SUPPORTED. SDHC CARDS ARE NOT YET SUPPORTED.

Serial/Ethernet Upgrade

The *Upgrade* button on the right side of the XTerm window is used to start a software upgrade using this method. The steps to perform this kind of upgrade, are as follows:

1. Download the upgrade from www.sutron.com/downloads/software.htm. The upgrade typically comes in a zipped archive, and typically has a name similar to "Xpert2 vX.X.X.X.zip". Once downloaded, unzip the archive onto your PC.
2. Connect your PC to the Xpert using a direct serial cable connection to COM1. Optionally, connect the Xpert to a DHCP-enabled network via ethernet cable.
3. Start XTerm.exe on your PC. To use ethernet (much faster than serial alone), start XTerm from a command prompt, and specify "/LAN" on the command line, e.g., "XTerm.exe COM1:115200 /LAN".
4. Press the "Upgrade" button on the right side of the XTerm window.
5. Select the file "Xpert2 vX.X.X.X.upg" (where X's are replaced by firmware version) in the Open dialog. The upgrade will proceed and finish automatically.
6. The contents of the upgrade file specify what part of the Xpert to upgrade. The parts upgraded may include the loader, kernel, application files, speech files, and custom

application files (SLLs). When Sutron releases a new version of software for the Xpert, the new version is distributed along with a new upgrade file.

7. After selecting the upgrade file, XTerm uses the upgrade file as a script to guide the upgrade process. Dialogs are displayed showing the progress of the upgrade. Occasionally, the upgrade script may cause the Xpert to reboot in order to make changes.

If for some reason the upgrade fails, the process will keep retrying and the last error will be displayed. If it appears the process is not going to complete you have the option to press Cancel and abort the upgrade. At this time you will be prompted if you'd like to view the recent serial port history. If you click yes then you can see what some of the recent messages and prompts issued by the data logger. This can be helpful in determining why the upgrade failed. A longer version of this history is also copied in to the clipboard. If you cannot determine the source of the problem you can edit-paste this information in to an email message explaining the problem and send it to Sutron Customer Service.

Customizing a Serial/Ethernet Upgrade

Users can make their own upgrade files or edit the ones provided by Sutron depending on individual needs. The upgrade file is a simple ASCII file such that it can be edited with notepad.exe.

An example upgrade file is shown below. To save space, the many steps required to delete all potential custom slls, and to send all possible speech files, have been left out.

```
; The following command tells XTerm this is an Xpert2 upgrade
script.
x
; Reboot Xpert2, bypassing autoexec.bat.
b "bypass"
;
; Remove old programs. If any other files need to be deleted before
the new
; files are deployed, then add them to this list. A typical example
would be
; an sll file you have written for Xpert2.
d "Basic.sll"
d "Coms.sll"
d "DefLib.sll"
d "Engine.dll"
d "Ezsetup.sll"
d "Logger.dll"
d "LogMgr.dll"
d "LZO.dll"
d "Remote.exe"
d "Satlink.sll"
d "SDI.dll"
d "Utils.dll"
d "Xpert.exe"
d "\Windows\Basic.sll"
d "\Windows\Coms.sll"
d "\Windows\DefLib.sll"
d "\Windows\Engine.dll"
```

```

d "\Windows\Ezsetup.sll"
d "\Windows\Logger.dll"
d "\Windows\LogMgr.dll"
d "\Windows\LZO.dll"
d "\Windows\Satlink.sll"
d "\Windows\SDI.dll"
d "\Windows\Utils.dll"
d "\Windows\Xpert.exe"
;
; Send over the standard application files.
s "Basic.sll"
s "Coms.sll"
s "Deflib.sll"
s "Engine.dll"
s "EzSetup.sll"
s "Logger.dll"
s "LogMgr.dll"
s "LZO.dll"
s "Remote.exe"
s "Satlink.sll"
s "SDI.dll"
s "Utils.dll"
s "Xpert.exe"
;
; Send over any extra slls desired. By default, these files are not
sent
; since they aren't used often. See the user manual for
descriptions.
; To send an extra sll, remove the semi-colon that precedes the
command.
p "sll-extra\"
s "GPRS232.sll"
s "NOS.sll"
p ""
;
; Send over default speech files.
m "\Flash Disk\Speech"
m "\Flash Disk\Speech\English"
p "Speech\English\"
s "0.vox" "\Flash Disk\Speech\English\0.vox"
s "1.vox" "\Flash Disk\Speech\English\1.vox"
s "10.vox" "\Flash Disk\Speech\English\10.vox"
p ""
;
; Send the autoexec.bat file over. This file typically starts
remote.exe and
; Xpert.exe after the system boots. When starting remote, it tells
it which
; com ports it should control and how to initialize them.
s "Autoexec.bat"
;

```

```

; Backup the registry in preparation for upgrading the kernel (which
re-inits
; registry, by default). The delay is designed to make sure launch
is finished
; backing up the registry before continuing. Launch automatically
restores the
; registry on its next execution at boot, which occurs after kernel
upgrade.
s "Xpert2.fil"
g "\Windows\Launch.exe" "/BACKUP AutoReg.dat /FILTER Xpert2.fil
/QUIET" " (saving registry)"
h "4" "-" " (saving registry)"
d "Xpert2.fil"
;
; Upgrade the kernel. The upgrade occurs serially, and will take
tens of minutes
; due to the size of the file.
k "Xpert2.ker" "-" " (kernel)"
;
; Upgrade the loader.
l "Xpert2.lod" "-" " (loader)"
;
; Upgrade MicroMonitor. This upgrade is disabled by default. As a
general rule,
; do not enable this step unless directed to do so by someone at
Sutron.
;u "Xpert2.mon" "-" " (umon)"

```

The commands used in the script are:

- p set default source directory
- d delete the specified file
- s send the specified file
- g run the specified executable file on the Xpert
- h delay for the specified number of seconds
- u upgrade MicroMonitor
- l upgrade the loader
- k upgrade the kernel
- b reboot

Format of commands:

CMD-LETTER "SOURCE" "DESTINATION" "NOTE"

CMD-LETTER is a single character specifying the command to perform

SOURCE is a quoted string specifying a file to operate on

DESTINATION is a quoted string specifying a file to operate on

NOTE is a message that will be displayed in the progress bar

Unused parameters at the end of a command may be omitted. Blank quoted strings are not allowed, use "-" if you wish to skip a parameter, but include a later one. If the default source directory is not provided, the directory where the upg file is located is used.

Storage Card Upgrade (SD or USB)

This method offers the benefit of speedy application and kernel upgrades, but cannot be used to upgrade the loader or micro monitor. Hence, this method should only be used when it is clear no upgrade of the loader or micro monitor is needed.

The steps to perform this kind of upgrade, are as follows:

1. The upgrade typically comes in a zipped archive, and typically has a name similar to "Xpert2 vX.X.X.X SC.zip" (SC in this case is meant to signify "storage card"). Once downloaded, unzip the archive onto an SD or USB card installed in your PC.
 - a. Alternatively, if the SD or USB card is not installed in your PC, but is instead installed in the Xpert, you may choose to:
 - i. Unzip the archive to your PC.
 - ii. Use the command line interface to create the same directory structure on the storage card as exists in the unzipped archive.
 - iii. Copy the contents of each unzipped archive directory to the corresponding storage card directory.
 - b. Alternatively, if you do not want to use a storage card, and you have at least 10MB available on the Xpert flash disk, you may choose to copy the unzipped archive to the \Flash Disk. You'll need to create the directory structure first using the command line interface in this case as well.
2. Insert the storage card into the Xpert (skip this step if you chose option b, above).
3. Select the "Upgrade Kernel and/or Application" option from the Setup tab.
4. The system will prompt you whether you want to upgrade using the upgrade found. Verify the upgrade found is the one you intended and select "Yes".
5. If the upgrade includes the kernel (true when the upgrade provides the file "Xpert2.ker" in the root of the upgrade archive), the system will prompt whether you wish to backup the registry. Answer "Yes".
6. The upgrade will begin and finish automatically, and may involve a reboot.

Customizing a Storage Card Upgrade

Upgrading using an SD or USB file in the manner described above uses an upgrade script file (text having "upg" extension) that is very similar to the one used when upgrading serially. The following commands are supported:

- p set default source directory
- d delete the specified file
- s send the specified file
- m make the specified directory (e.g., m "\Flash Disk\Speech")
- r rename specified file (e.g., r "\Flash Disk\DefLib.sll" "\Flash Disk\Deflib.bak")

Manual Component Upgrade

Individual firmware components can be upgraded using a variety of methods other than those listed above. This section describes a few of those methods.

Be careful upgrading individual components of Xpert firmware because of incompatibilities across different versions. The set of files contained in a single download archive from the website are all compatible. As a general rule, don't mix with other versions, unless specifically told to do so by Sutron customer service.

Upgrade the Boot Loader

The Xpert boot menu provides the ability to upgrade the Xpert boot loader, either by serial or ethernet transfer.

1. Download either the serial or storage card upgrade from the Sutron website, at the following address: www.sutron.com/downloads/software.htm. The upgrade typically comes in a zipped archive, and typically has a name similar to "Xpert2 v3.0.zip". Once downloaded, unzip the archive onto your PC. The boot loader is stored in the file "Xpert2.lod".
2. Start hyperterm or other terminal program on a PC. Set the baud rate to 115,200. Connect the COM1 serial port to the Xpert. If you intend to transfer the boot loader file via ethernet, connect the Xpert to a network that supports DHCP using an ethernet cable.
3. Power up the Xpert. Press ESC in response to the message "Press ESC now to Upgrade System".
4. Press "L" to indicate you want to transfer the boot loader.
5. Press "U" to indicate you want to upgrade the boot loader.
6. Use the menus that follow to specify either a transfer via ymodem or ethernet, and follow the instructions to send the file Xpert2.lod, downloaded in step 1.
7. After the upgrade is complete, reboot the Xpert.

Upgrade the Kernel

The Xpert boot menu provides the ability to upgrade the Xpert kernel, either by serial or ethernet transfer.

1. Download either the serial or storage card upgrade from the Sutron website, at the following address: www.sutron.com/downloads/software.htm. The upgrade typically comes in a zipped archive, and typically has a name similar to "Xpert2 v3.0.zip". Once downloaded, unzip the archive onto your PC. The kernel is stored in the file "Xpert2.ker".
2. Start hyperterm or other terminal program on a PC. Set the baud rate to 115,200. Connect the COM1 serial port to the Xpert. If you intend to transfer the kernel file via ethernet, connect the Xpert to a network that supports DHCP using an ethernet cable.
3. Power up the Xpert. Press ESC in response to the message "Press ESC now to Upgrade System".
4. Press "K" to indicate you want to transfer the kernel.
5. Press "U" to indicate you want to upgrade the kernel.
6. Use the menus that follow to specify either a transfer via ymodem or ethernet, and follow the instructions to send the file Xpert2.ker, downloaded in step 1.
7. After the upgrade is complete, reboot the Xpert.

Upgrade the Application

The Xpert application (Xpert.exe and associated dlls and slls, as well as remote.exe) can be upgraded using the steps outlined in this section. Use great caution here, as mixing different versions of slls and dlls can cause very strange, hard to diagnose, behavior.

1. Download either the serial or storage card upgrade from the Sutron website, at the following address: www.sutron.com/downloads/software.htm. The upgrade typically comes in a zipped archive, and typically has a name similar to "Xpert2 vX.X.X.X.zip". Once downloaded, unzip the archive onto your PC. The Xpert application consists of Xpert.exe, all dll files (*.dll), and all standard sll files (those files with *.sll extension that do not appear in the "extra sll" directory). Of course, you may also use one or more sll files in the extra sll directory.
2. Start hyperterm or other terminal program on a PC. Set the baud rate to 115,200. Connect the COM1 serial port to the Xpert. If you intend to transfer files via ethernet, connect the Xpert to a network that supports DHCP using an ethernet cable.
3. Power up the Xpert. Press Ctrl-C in response to the message "Press Ctrl-C to skip execution of Autoexec.bat". You should then see "Bypassing \flash disk\Autoexec.bat, running Remote" in the next few lines. If you do not, simply repeat this step until you do.
4. If you intend to use ethernet and the ethernet port lights are off, issue the command "lanon". If you intend to perform serial transfers, close the terminal program. In any case, run XTerm and connect to the Xpert.
5. Press the XTerm "File Transfer" button on the right of the XTerm display. This will bring up a dialog showing a list of Xpert files in the right pane, and a list of PC files in the left pane. Make sure the right pane is showing files in the "Flash Disk" subdirectory.
6. Change the directory in the left pane to the directory containing the upgrade files, and select the files you want to send to the Xpert (note: you can select multiple files by holding down the Ctrl key with each new selection).
7. Press the ==> button to transfer the files to the Xpert. Press OK to start the transfer and wait for the transfer to complete.
8. When finished, reboot the Xpert.

NOTE: Xpert app now contains some additional checks to ensure the correct version of ssl/dll is loaded. If the app detects an incorrect version, it WILL NOT load that sll/dll. If this happens, a warning message is shown on boot-up and a warning message will be placed into the system log indicating what version was found and what is expected. If this happens, simply copy the correct version of dll/sll onto the flash disk and re-boot the unit.

Appendix C: I/O Modules

ANALOG I/O MODULE – 8080-0003

The Analog I/O Module (ADC) has six analog I/O lines, an output that can be switched to ground and switched and unswitched 12 volt outputs. The analog lines are capable of being inputs and outputs simultaneously giving the user tremendous flexibility in setup. As an example, the simple resistance measurement is made by exciting the input the resistor is connected to and measuring the current and voltage on that input line just as would be done using a conventional multimeter.

Features

Six inputs configurable as 6 single ended channels or 3 differential inputs or a combination of single ended and differential inputs. All channels feature self-excitation and built-in voltage, current and resistance sensing.

Input gain settings 1, 16

Up to 6 4-20ma sensor interface

24 bit analog to digital converter

Continuous self-calibration

Vout (excitation) return for maximum common mode rejection of bridge sensors

One switched battery sensor power output

Industrial temperature range operation -40 to $+60^{\circ}\text{C}$

Multiple sampling rates and digital filtering

Ability to make resistance measurements without additional external resistors.

Viewing the card from the front, the plug assignments are as follows:

1	2	3	4	5	6	7	8	9	10	11	12	13	14	15	16	17	18
G	1 1+	G	2 1-	G	3 3+	G	4 3-	G	5 5+	6 5-	Sw Gnd	- EX	N C	G	G	Bat	Sw Bat

G = Ground

Bat = 12 volts out

SwBat = switched 12 volts out

SwGnd = switch to ground

-EX = negated excitation voltage

NC = No Connections

Differential channel pairs are 1-2, 3-4, 5-6. The higher voltage line goes to the odd line.

Specifications

Parameter	Min	Typ	Max	Units
Input				
Range	-5		5	Volts
Absolute Error 25°C			0.0015	%FS ⁵
-40°C to +60°C			0.03	%FS ⁵
Ratiometric Error ¹			0.0015	%FS ⁵
CMRR		70		dB
60Hz Rejection	100			dB
Rin				
Single Ended	20			Meg Ω
Differential	20			Meg Ω
Common Mode	20			Meg Ω
Filter Range	10		2000	Hz
Excitation				
Range	-5.0		+5.0	
Output Current			10	mA
Output Impedance		110		Ω
Absolute Error 25°C			0.0015	%FS
-40°C to +60°C			0.03	%FS
Ratiometric Error ²			0.005	%FS
Frequency	0		10	Hz
Sensor Power (VBAT from Data Logger)				
Voltage	9		14	Volts
Current			100	mA
Protection				
Static Discharge ³			2000	Volts
Conducted ⁴			400	Volts

¹Error which will not cancel when two measurements are expressed as a ratio.

²The excitation outputs are connected internally to the analog to digital converter. This value is the accuracy of this measurement. Available voltages are the integer values between -5 and +5 V.

³ Human body model.

⁴ One microsecond rise, one milli-second fall.

⁵ Channel 1, Differential over -4.8 to 4.8 Vin

Operational States

The ADC has two operational states - *running* and *stopped* - which are controlled by commands to the device.

Running

In this state, the input lines are sampled and processed. This state consumes more power than the stopped state, so the ADC card should be left running only if necessary. The digital output line may be pulsed using the pulse command. The ADC executes a reset sequence when it receives the run command. When the reset is complete, a message is sent to the host.

Stopped

In this state, the device is idle. It will accept commands, and the output SwGnd will reflect the last command that set this output to either open (1) or switched to ground (0). The input lines are not sampled. Pulse commands will be ignored in this state.

Inputs/Outputs

Inputs

The ADC has six single ended analog inputs which may be paired to form differential inputs.

Outputs

The ADC provides:

One 12-volt output (Bat)

One switched 12-volt output (SwBat)

One output that can be switched to ground (SwGnd)

Six excitation channels (analog outputs) that can be programmed from $-5V$ to $+5V$, and,

One output $-Ex$ which is always the negative of the current excitation voltage value.

The excitation channels are shared with the input lines. Only one excitation channel can be active at a time. The negative of this voltage provided on $-Ex$ can be useful in balanced bridge applications to minimize common mode voltage.

The output SwGnd provides a switched path to ground that, when closed, grounds through a 100-Ohm resistor. The state of this output may be pulsed using the pulse command. It may be pulsed open or closed. If the output is already in the state that the pulse command requests, nothing will happen. The ADC device must be in the running state to pulse SwGnd.

The board must be in the running state to switch the SwBat on. This will turn off if the device goes to the off state.

Analog Measurements

The ADC can measure voltages on its terminals and across internal sense elements. Sense element voltages allow currents to be calculated by a host processor. The ADC can also take paired terminal voltage and sense element voltage measurements that can be used to compute resistance values.

The ADC has a built-in low pass filter for noise rejection that is programmable for a 10 to 1900 Hz cutoff. The filter has notches at multiples of the cutoff frequency.

The ADC provides for up to 65.535 seconds of sensor warm-up delay before making its first measurement. If the specified warm-up delay is less than 3 sampling periods, the delay before the first reading is taken will be 3 sampling periods. This should be taken into account when computing the warm-up delay.

Accuracy

The ADC will self calibrate to its internal reference whenever the calibrate command is received. The reference, while very stable, is accurate to $\pm 1\text{mV}$. This error is measured during factory test and is written into the ADC ROM. A read Vref error command can be used to read this error and use it to obtain 0.0015% error (at 25°C). Another set of coefficients can be read to calibrate readings when the ADC gain is set to 16.

Example Configurations Using the 8080-0003 Analog I/O Module

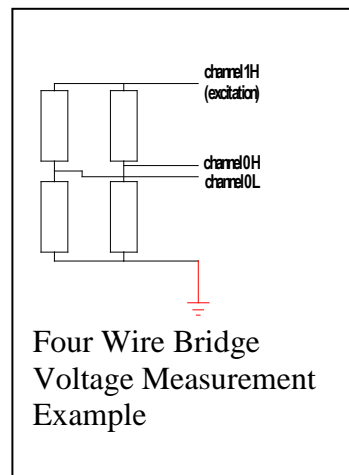
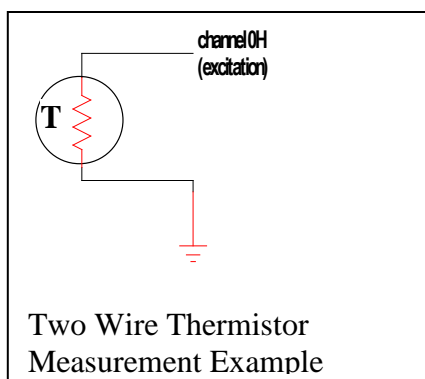
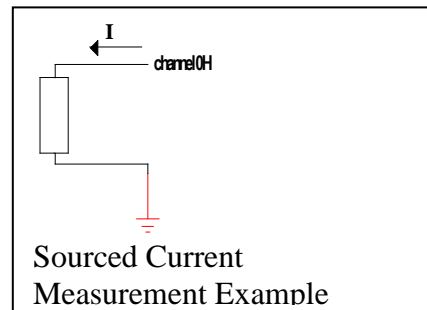
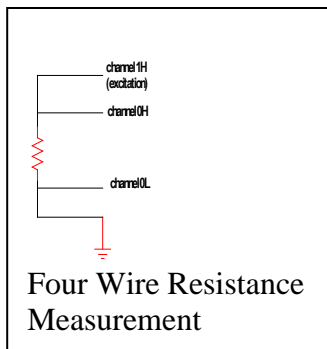
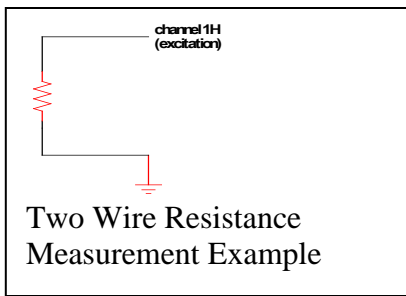
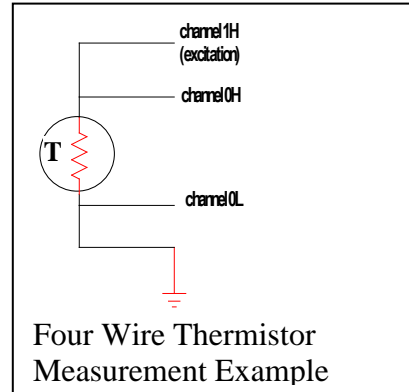
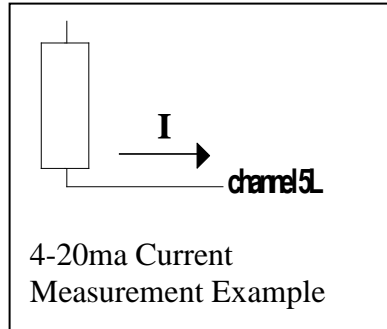
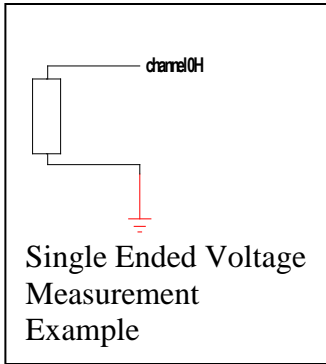

ANALOG I/O MODULE – 8080-0007

The 8080-0007 Analog I/O Module (ADC) has ten analog I/O lines, an excitation voltage, switched battery output, and built in transient protection.

Features

Ten inputs configurable as 10 single ended channels or 5 differential inputs or a combination of single ended and differential inputs.

16 bit resolution

Input gain settings for increased resolution for low level signals

Single Ended: 0-5 V, ± 78 mV, ± 19.5 mV (ADC Block: Voltage, HiGain, x128)

Differential: ± 2.5 V, ± 78 mV, ± 19.5 mV (ADC Block: Voltage, HiGain, x128)

Continuous self-calibration

One switched battery sensor power output

Industrial temperature range operation -40 to $+60^{\circ}\text{C}$

Multiple sampling rates and digital filtering

Viewing the card from the front, the plug assignments are as follows:

1	2	3	4	5	6	7	8	9	10	11	12	13	14	15	16	17	18
1	2	G	3	4	G	5	6	G	7	8	G	9	10	G	Vref	G	SwBat
1+	1-		3+	3-		5+	5-		7+	7-		9+	9-				
2-	2+		4-	4+		6-	6+		8-	8+		10-	10+				

G = Ground

SwBat = switched battery out (12V nominal)

Vref = 2.5V excitation voltage – only on when the module is measuring.

Differential channel pairs are 1-2, 3-4, 5-6, 7-8, 9-10. The higher voltage line goes to the measured channel.

Transient Protection Installation Note

The two rear 6-32 mounting screws provide the earth grounding point for the internal spark gap transient protection of the analog inputs. For maximum transient protection a good earth ground needs to be provided to at least one of these screws.

Specifications

Input Range:	-0.1 to 5V (any input with respect to ground, single ended or differential)
A/D Range	
Single Ended:	0-5 V, ± 78 mV, ± 19.5 mV (with respect to ground)
Differential:	± 2.5 V, ± 78 mV, ± 19.5 mV (+ input with respect to – input)
CMRR:	120 dB typ
Input Impedance:	> 10 Gohm typ
Accuracy:	0.002% of 5V typ 0.003% of 78mV typ HiGain 0.03% of 19.5mV typ x128Gain
Temp Coefficient:	5 ppm/C typ
Ratio Accuracy:	Limited by A/D resolution (no non-linearities or TC seen).
Noise floor:	RMS noise typically < 1bit on 78mV scale and above.
Excitation:	2.5V (up to 50 mA)
SwBat:	250 mA
Protection:	Multistage input protection including spark gaps.

Example Configurations Using the 8080-0007 Analog I/O Module

Note: All references to Vref and AGND are to the terminals on the module performing the measurement. Do not connect to similarly named terminals on other modules.

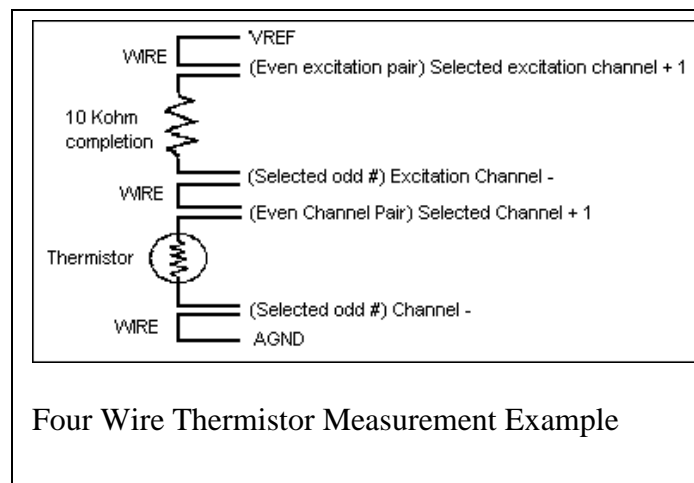
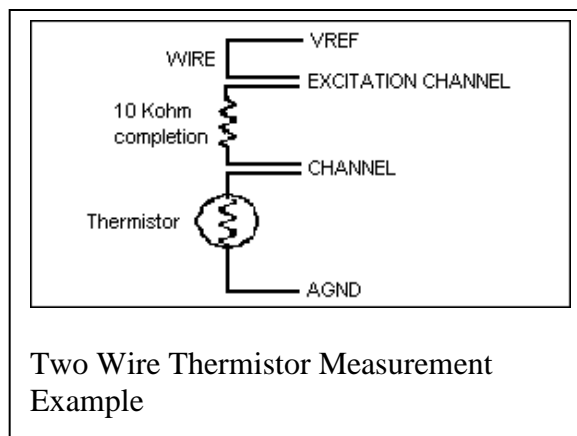
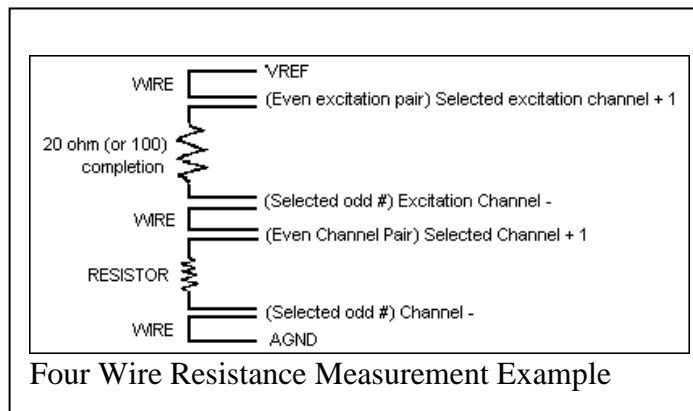
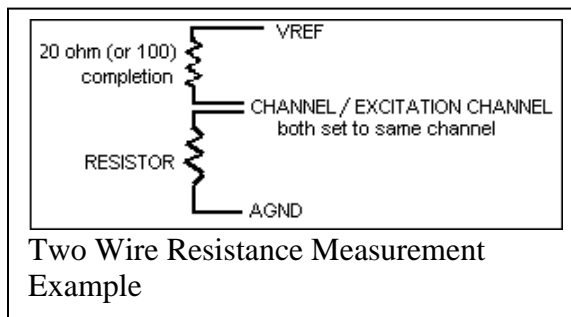
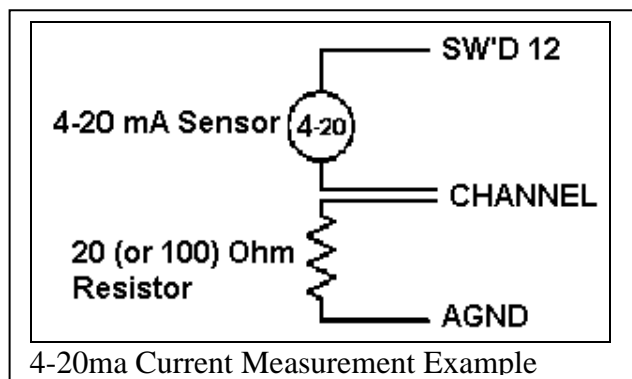
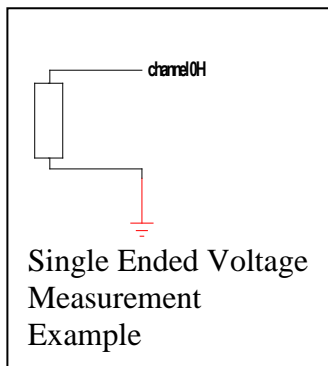

DIGITAL I/O MODULE – 8080-0002

This section describes the control and operation of the Xpert Digital I/O module. The Digital I/O module has eight digital input lines, six of which may be re-programmed as outputs. The two dedicated input lines can be programmed for normal sensitivity for sensing 0 to 5 volt digital signals, or high sensitivity for sensing low level signals such as those from an R.M. Young wind speed sensor.

Features

Eight digital I/O lines, CMOS level inputs

Six bi-directional, two input only

Reconfigurable I/O

Up to eight counters/frequency inputs with programmable alarm count leading edge, trailing edge or both edges of input pulse.

Up to four quadrature shaft encoder inputs (requires two inputs per sensor) with programmable alarm

Two switchable threshold inputs compatible with R M Young wind sensor.

Switched sensor power

Industrial temperature range operation -40 to $+60^{\circ}\text{C}$

Parameter	Min	Typ	Max	Units
Inputs				
Inputs				
Sampling Interval		500		microseconds
Switchable threshold	.02		2.5 ¹	Volts
Output(open drain MOS switches)				
Pull-up voltage	0		14	Volts
Resistance	80		125	Ω
Current			70	mA
SW BAT output				
Current			100	mA
Protection				
Static discharge ²			2000	Volts
Lightning, Conducted ³			400	Volts

¹CMOS levels.

²Human body model.

³1 microsecond rise, 1 millisecond fall.

Viewing the card from the front, the plug assignments are as shown below. The I/O lines are numbered 1-8 (LSB is 1).

1	2	3	4	5	6	7	8	9	10	11	12	13	14	15	16	17	18
---	---	---	---	---	---	---	---	---	----	----	----	----	----	----	----	----	----

G	1 *	G	2	G	3	G	4	G	5	G	6	G	7 #	G	8 *#	G	SW BAT
---	--------	---	---	---	---	---	---	---	---	---	---	---	-----	---	---------	---	-----------

G = Ground

* = Input Only

= Switchable sensitivity

Inputs

When programmed as an input, each line can act as a digitally filtered counter clock or a shaft encoder input. Shaft encoders require two input lines, hence, users can have up to four shaft encoders, eight counters, or a combination of the two. When a run command is received, sampling of the inputs starts.

Digital filters

The inputs can be low pass filtered before being applied to counters. Shaft encoders are not filtered. The digital filters are up-down counters that count between 0 and a user defined threshold value. Each input line's filter can have a different threshold value. The input to a filter is one of the eight input lines, the output feeds a 32-bit counter. The filter counts up at each sample interval when its input is a one and down when its input is a zero. The counter will not count up if it is at its upper threshold, and it won't count down when its count is zero. The output of the filter only changes state when the counter reaches zero or its upper threshold. Thus, if the output state of the filter is a one, it will stay a one until the counter reaches zero. It will then remain zero until the counter counts up to its upper threshold. Valid digital filter time constants are 1 to 255.

Counters

Up to eight 32-bit counters can be programmed to count on both edges or just the positive-going edge of their respective inputs. Since the input to the counter can be inverted under program control, the counter can also be made to count on the negative going edge by inverting its input. The counter alarm message can be set to be sent after 1 to 255 counts.

Frequency

The time is logged for each counter every time it counts. This time is reported for each counter when the counters are read. Frequency can be measured by reading the counters twice and computing the difference in time and counts.

Shaft encoders

Up to four quadrature shaft encoders may be set up. The input lines must come from adjacent inputs starting with an odd numbered one (e.g.: 1,2; 3,4; 5,6; 7,8). Each shaft encoder has a 32-bit counter associated with it. It counts up for one direction of rotation and down for the other.

Outputs

Each of the six lines with output capability can be turned on or off under control of the logger. Any output can be pulsed using the pulse output command.

Appendix D: Specifications

Basic Unit with Display – 8080-0000-1B, 8080-0000-2B, and 8080-0000-3B

Processor	32 bit ARM9 core
Memory	1 MB boot ROM 64MB Flash (32MB for OS and 32MB flash file system for log) 32MB SDRAM
Power	10 to 16 VDC recommended (20 VDC max) 140 mA display and backlight on 40 mA active (display & backlight off) <3 mA quiescent
Clock	TCXO Real-time clock with battery backup 10 seconds/month accuracy -40 to +60C
Display	320x240 transfective LCD Touchscreen overlay for LCD -20C to +60C viewable
I/O	I2C bus, 100Kbps, 5 wire, 10ft max SDI-12 Rev 1.3 RS232 to 115Kbps Internal speaker 4 RS232 (-1B) 8 RS232 (-2B) or 7 RS232 1 RS485 (-3B) USB Host port SD Host slot
Packaging	6 x 8 x 2 5/16 aluminum case Weight: 2lbs
Compatibility	Y-Modem SSP Satlink
Environmental	-40 to +60C operation

Basic Unit without Display – 8080-0001-1B

The specifications for the basic unit without display is the same as the unit with display except there is no display or touchscreen.

I²C Modules

Packaging	4.5 x 4.7 x 1 inches 0.5lbs stacking interconnect
Connectors	I2C bus: DB-9 User I/O: Phoenix Combicon 5 mm x 18 max, removable header

RS232 Modules

Speech Modem

A telephone modem expands the system by allowing remote connections to other nodes including a central system. The module includes a modem capable of operation at speeds up to

33.6 kbps. This makes it possible for the remote connection to perform all functions as though the module were local to the system such as retrieve data from the memory module, live data from any module, troubleshoot, diagnose, configure, reconfigure nodes etc. Sutron 8080-0005-1 modem includes V.42 and MNP 2-4 and 10 error correction modes as well as V.42bis and MNP-5 data compression. The modem is UL, CSA, FCC and CTR21 approved.

The Sutron 8080-0005-1 modem has capabilities to support speech. The modem accepts DTMF tones to control the speech and interact with a caller. The user can record custom phrases and words to augment the standard vocabulary using standard PC hardware and software.

LOS Radio

The recorder has a serial port for connecting LOS Radio modems. The port is compatible with third party radio modems such as those manufactured by MDS. Using a radio modem provides one or two way communications between nodes or a central station. The modem makes it possible for the remote connection to perform all functions as though the module were local to the system. Two nodes may use radio communications over a short distance to eliminate expensive wiring. At other times, radio communications will be used between the nodes and a central station. The radio modems must be compatible with repeaters in cases where there is not a clear line-of-sight between two nodes.

Satlink Transmitter

The recorder has a serial port for connecting a Sutron Satlink transmitter. The recorder will set up and operate the satellite radio through the serial port. The setup includes specifying of the transmit mode, ID, time, interval, setting the time, making test transmissions etc. Operations include loading data for transmission, logging transmission status and exceptions, synchronizing clocks etc.

Appendix E: Software Development Kit (SDK)

OVERVIEW

The Xpert Software Development Kit (SDK) enables developers to create Sutron Link Libraries (SLLs) that extend Xpert's functionality according to the developer's unique needs. The SDK is most often used to create libraries containing custom *setup blocks*, *property pages (tabs on the main screen)*, and *control panel entries* (branches in the tree under the Setup tab), but may also be used to create libraries that manipulate ports, files, peripherals, and any other entity accessible through standard Windows CE operating system API calls.

The SDK is may be downloaded from Sutron's website at:

<http://www.sutron.com/DownloadsUpdates/XpertSDK.htm>

The SDK is intended for use with Microsoft eMbedded Visual Tools (EVT) 3.0 which, at the time of this writing, is available at no charge from Microsoft. This toolset contains the compiler, linker, and operating system libraries necessary to develop for the Xpert platform. It may be ordered on CD from Microsoft (in which case a modest shipping charge applies), or downloaded from:

<http://www.microsoft.com/downloads/details.aspx?FamilyID=F663BF48-31EE-4CBE-AAC5-0AFFD5FB27DD&displaylang=en>.

Sutron assumes that any developer using the tools is already knowledgeable concerning C++ and basic Windows programming.

Please note that custom SLLs must be rebuilt (compiled and linked using EVT 3.0) whenever you upgrade to a new version of Xpert firmware. This must be done with the version of the SDK that matches the version of Xpert firmware.

Appendix F: Creating Custom Voice Files

OVERVIEW

Xpert speech files are binary data files containing audio data in Rockwell 4-bit ADPCM 7200hz mono format. These files are "headerless", meaning they have no information describing the content of the file, just sample data. Users can create these files using one of several aftermarket programs for the PC. One such program is "Vox Studio" by Xentec. This program allows the user to record speech using a microphone connected to the PC, and save it in the appropriate format (Rockwell 4-bit ADPCM 7200hz mono). The file can then be loaded into the Xpert using Xterm (into the corresponding language subdirectory under \flash disk\speech\, e.g., English, Spanish, etc.), and used by selecting it in a ComsTag dialog, just as you would any other speech file. (Note: You will need to save the file with a unique name and with the extension ".vox" so that the Xpert will display the file for selection).

The program "Vox Studio", by Xentec, is available for download at: <http://www.xentec.be/download/download.htm>. Note: the unregistered version of this program limits the length of files to 5 seconds. As of this writing, a fee of \$399 is required to register, which removes the limitation.

When using Vox Studio or any other editing program, Sutron recommends trimming off the leading and trailing silence to help reduce the size of the file. We also recommend using the normalize function to adjust the volume of the recorded phrase.

Appendix G: Autoexec.bat and Remote.exe

AUTOEXEC.BAT

Starting with version 2.0.0.0 and greater, the autoexec.bat file is AUTOMATICALLY updated by the system when changes to the COMS are made. The only time a user needs to modify the autoexec.bat file manually is if the autoexec.bat file is corrupted or missing.

The Xpert executes instructions in the \flash disk\autoexec.bat file on startup. If the file doesn't exist, or if the user cancels execution, the system will run \windows\remote.exe com1:115200. This remote.exe program is the program that allows communication with XTerm. With remote.exe running, you will be able to update the software, setups and monitor the system as needed.

To skip autoexec.bat on Xpert, touch the screen while turning on the Xpert and remain touching it until you see a message box displayed. The message box will ask if you want to skip the execution of autoexec.bat. Press YES. If you press NO, the system will continue and execute autoexec.bat.

To skip the autoexec.bat via a terminal program, connect a PC running a terminal program to COM1 and apply power to the unit. After the terminal displays "Flushing caches", press CTRL key and C <CTRL-C>, hold until message displays "Bypassing \flash disk\Autoexec.bat..."

The factory default for autoexec.bat is as follows:

```
\windows\remote.exe com1:115200
\windows\Xpert.exe
```

The first line runs remote.exe, enabling communications on com1. The second line runs the main Xpert application program. The details of running remote.exe are explained in the following section. Xpert.exe accepts several command line options:

```
/Debug      send debug messages to the serial port
/SDI COM4:  use COM4 for SDI-12
```

NOTE: If redirecting SDI to a different com port, the com port settings in the Coms (SSP/CL) section of setup should be left as None. Coms (SSP/CL) is strictly for configuring SSP and Command Line communication devices (e.g., Modem, Voice Modem, Radio, etc.).

You may make changes to the autoexec.bat by editing the file on your PC and then transferring it to the Xpert. However, if you make a mistake and render it inoperable, you will need to follow the instructions to skip autoexec.bat on startup so you can transfer a correct autoexec.bat to the Xpert.

REMOTE.EXE

The system has a remote.exe in the \windows directory. However, it is possible to load an updated version into \flash disk and run it instead of the version in \windows. Remote can support different communications devices on each of its serial ports. All the ports are specified by the command line arguments when remote.exe is run.

Remote supports the following communications devices:

Name	Device	H/W Flow	Description
COMx	Direct connection to a PC	RTS/CTS	The Xpert is connected to a PC using a RS232 cable. Typically the PC will run XTerm, PCBASE2 or XCONNECT. Both a command prompt and SSP are available.
MODEMx	Commercial modem.	RTS/CTS	The Xpert is connected to a Hayes compatible telephone modem. No voice functions will be supported.
RADIOx	LOS Radio modem.	None	The Xpert is connected to a LOS radio modem. The Xpert can communicate with other stations and master stations on the radio network using SSP.
VOICEx	Sutron Voice/Modem.	RTS/CTS	The Xpert is connected to Sutron's Voice Modem. Both Voice and Data functions will be supported.
SSPx	SSP only direct connection	None (*)	The Xpert is connected to a Xpert, a Base Station PC, or another RTU that supports SSP using an RS232 cable. Typically the PC will run XTerm, PCBASE2 or XCONNECT.
RSx	RS-485 connection	None	The Xpert is directly connected to another Xpert using SSP.

Where x is the COM port number 1 to 4

(*) H/W Flow control was enabled on SSP ports before version 2.3, and may be re-enabled if needed with the /HS option.

Remote also supports the following command line arguments:

Option	Description
/F UnitID	ID to respond to when receiving an SSP message (note this can be omitted if the user has set the station name.)
/T MasterID	ID to use in SSP message when sending an alarm

/HSx+	Force hardware RTS/CTS handshaking on, on port x. Use this to enable handshaking on a device mode which normally has it disabled (i.e. RADIO or SSP).
/HSx-	Force hardware RTS/CTS handshaking off, on port x. Use this to disable handshaking on a device mode which normally has it enabled (i.e. COM, MODEM, VOICE).
/DTRx+	Force DTR to be enabled all the time on port x when used in conjunction with a port in SSP: or COM: modes. In SSP: mode DTR is asserted whenever data is transmitted, and in COM: mode DTR is asserted whenever a connection is made. This switch has no effect on RADIO: mode where DTR is used to key the transmitter, or MODEM: or VOICE: mode where DTR is used to hangup the phone.
/DTRx-	Force DTR to be disabled all the time on port x, when used in conjunction with a port in SSP: or COM: modes.
/AUTOLOGON	Causes command prompt sessions to automatically login as the user name "AUTO" with no password. This can be used to limit access to the system, or to allow a custom command parser full control of the session.
/DEBUG	Disables resetting of unit by the software watchdog so it doesn't interfere with debugging code.
/NOCOM1	Causes a session on COM1: not to be started so COM1: may be used for some other purpose.

Example: the following command runs remote.exe to support a direct connection on COM1 and a Sutron voice modem on COM3:

```
\flash disk\remote.exe com1:115200 voice3:115200
```

It's usually not possible to place special command line options for Remote in the Autoexec.bat file because whenever a com port setting is changed in the Xpert application, the settings you make will be replaced. For this purpose extra command line options may be placed in a file called "Remote.opt". This is a simple ASCII text file that can be created with notepad and transferred to the Xpert and placed in the \Flash Disk folder. It can contain a single line of options that are concatenated to the parameters passed to Remote in the Autoexec.bat. So for instance, if you wished to enable AUTOLOGON and disable H/W handshake on port 2, you would place the following in the Remote.opt file:

```
/AUTOLOGON /HS2-
```

Bypassing Autoexec.bat by pressing Ctrl-C will also bypass any options in the Remote.opt file as of version 3.2.

Remote.exe is designed to communicate with Sutron's XTerm program to provide a wide range of functions. In addition, you can use a terminal emulator with remote and issue one of the following commands. Note: if you have set up any usernames and passwords in the Xpert, you will be prompted to enter a username and password in order to issue commands to remote.exe

Table of remote commands:

Command	Description
ABOUT	Shows the same information as the Xpert's Status tab, About button
CAL sensor value	Calibrate "sensor" using "value". Where sensor is the name of the block and must be a unique name (see rename for details). For example, to calibrate a sensor block named "stage" to value 15.5: ex. cal stage 15.5
CD path	Change directory
COPY src dest	Copy a file. A wildcard * character may be used as part of the src to match one or more files, but then dest should contain the name of a folder. If a path contains spaces it must be surrounded in double quotes. ex: copy "\usb card*.*)" "\flash disk\"
DATE [mm-dd-yyyy]	Displays or sets the date
DEFAULT	Exits and runs \Windows\Remote COM1:115200
DEL file	Delete file
DIR path	Display directory
GET [sensor-list] [/F logfile] [/S mm-dd-yyyy hh:mm:ss] [/E mm-dd-yyyy hh:mm:ss] [/CSV] [/YMODEM] [/ZIP] [/C] [/REVERSE] [/BAD] [/INVERT] [/OLDEST] [/NEWEST] [/TODAY] [/YESTERDAY] [/WEEK] [/MONTH] [/YEAR] [/HOUR]	Shows archived log data. Specifying a sensor-list will cause only those sensors to be displayed. <ul style="list-style-type: none"> • /F specifies a logfile, SSP.LOG is used by default. • /S specifies a start date and time for retrieval. If a start date is not specified then it will default to where the last GET left off. • /E specifies an end date and time for retrieval. If an end date is not specified the end of the log is assumed. • /CSV will use a comma-separated format . /CSV will also show more decimal places (by default only 3 places are shown to help keep columns aligned). • /YMODEM will cause the report to be transferred as <sitename>_YYYYMMDD.TXT, where <sitename> is the name of the station, and YYYYMMDD is the date of the first entry in the log. If the data is from a log other than SSP.log then the format of the file created will be as follows: <sitename>_<logfile>_YYYYMMDD.TXT. • /ZIP will cause the output to be compressed in to a .ZIP archive file with a .ZIP extension. • If there are more than 24 lines of output, the display will

	<p>pause with a “– More –” prompt until space is pressed to continue, or ESC to abort</p> <ul style="list-style-type: none"> • /C will cause the output to be continuous (without pause) until the end is reached or ESC is pressed. • /REVERSE will cause the output to be generated in reverse time order (newest to oldest). • /BAD will cause only bad data, and system errors to be displayed. • /INVERT will display all sensors that are not contained in the sensor-list. • /OLDEST will start the dump with the oldest data in the log. • /NEWEST will start the dump with the newest data in the log, especially useful when combined with /REVERSE. • /TODAY will start the dump with today. • /YESTERDAY will start the dump with yesterday. • /WEEK will start the dump with the last Sunday. • /MONTH will start the dump with the 1st of the current month. • /YEAR will start the dump at Jan 1 of the current year. • /HOUR will start the dump at the top of the current hour.
HELP	Displays the list of commands.
INFO	Shows the same information as the Xpert’s Status Tab
IPCONFIG [/ALL]	Displays the ethernet configuration information that has been assigned by a connected router via the DHCP protocol including the IP address assigned to the Xpert. The /ALL option includes more detailed information including the physical address (i.e. MAC ID) and DHCP lease times.
LANOFF	Turns OFF the Ethernet (Local Area Network) interface
LANON	Turns ON the Ethernet (Local Area Network) interface. DHCP is used to locate the gateway, retrieve the IP address and other internet settings. Use the IpConfig command to view the current settings. Also related: Release, Renew.
LOGOUT	Logout (also quit or exit)
MAIL [port to msg]	Reads or sends mail message
MD dir	Make a directory
MEASURE [...]	Measure works exactly the same as the SHOW command except it causes a live-reading of the sensor values to be taken before the results are displayed.

MEM	Display memory usage
PASSTHRU port:parity,bits,stop [/HW] [/ECHO] [/BREAK] [/CONTROL]	<p>Opens the specified port (either unopened or under the control of remote), where port can be COM2 or VOICE3 or SSP2 depending on how the port is configured. For generic serial ports, use COM and the port number. If the port is in use by other sll ports (GPRS, iridium, etc), the port must first be disabled, then re-enabled when finished. Any characters typed are sent to the port. Any characters received are displayed. Terminate with by pressing ESC three times in a row.</p> <ul style="list-style-type: none"> • The /HW option enables RTS/CTS h/w handshaking. • The /ECHO option causes the characters you type to be echoed back which can be useful when communicating with half-duplex devices. • The /BREAK option will send a 500ms break to the serial port after connecting. This may be used to wakeup sensors which require a break. • The /CONTROL option (added in version 3.4) allows the DTR control line to be passed through. This used to be the default behavior, but as of 3.4 dropping DTR or disconnecting will cause a logout to occur. <p>The normal user inactivity timeout will be applied to passthru sessions.</p> <p>Note: If using passthru to access a port already under control of Remote, then the existing port settings are always used. This includes hardware handshaking. If you try to communicate with a port with hardware handshaking enabled, and CTS is low preventing transmission, then the message [CTS LOW] is displayed.</p> <p>Pressing ESC twice, followed by a ? will show the status of the control lines (H high, L Low), pressing ? again any number of times will update the current status of those lines, pressing any other key will stop checking the status of the lines and return to passthru mode.</p>
RD dir	Remove a directory
REBOOT	Reboots the Xpert
RECORDING [on off]	The RECORDING command will display the current recording status. If “on” is specified then recording is turned on, likewise “off” will turn recording off.
RELEASE [adapter]	Releases DHCP leases on network adapters or the specific adapter if specified. The adapter index can be retrieved and the current lease viewed with the “IPCONFIG /ALL”

	command. DHCP leases are usually managed automatically, but this command can be used to verify that a connected router is assigning IP addresses reliably.
REN old new	Rename a file
RENEW [adapter]	Renews DHCP leases on network adapters or the specific adapter if specified. The adapter index can be retrieved and the current lease viewed with the “IPCONFIG /ALL” command. DHCP leases are usually managed automatically, but this command can be used to verify that a connected router is assigning IP addresses reliably..
REPORT mode	Set status reporting to on, off, none, ssp[0-9], low, medium, high, i2c, all, debug. (more below)
SET sensor[:value] data	Sets the current value of a tag to the specified data. For tags with multiple possible values, the value number may be specified (1-n). Data may be an integer, a floating point number, or a double-quoted string.
SHOW [sensor-list] [/SENSOR/TAG] [/CSV] [/YMODEM] [/C]	<p>The SHOW command by itself will display the current value for every sensor and tag, that does not have a “U” quality, in the system in a tabular report. Sensors are the input blocks in the system. Tags include any intermediate or final value in the setup marked with a ComsTag, a custom tag created with Basic, or a Field Variable.</p> <ul style="list-style-type: none"> • Specifying a sensor-list will cause only those sensors and tags to be displayed (sensors and tags can have the same name). • /SENSOR shows only sensors. • /TAG shows only tags. • /CSV will use a comma-separated and quoted format that can be imported in to a spreadsheet. /CSV will also show more decimal places (by default only 3 places are shown to help keep columns aligned). • /YMODEM will cause the report to be transferred using the Ymodem protocol as <sitename>_show.TXT, where <sitename> is the name of the station. • If there are more than 24 lines of output, the display will pause with a “– More –” prompt until enter is pressed to continue, or ESC to abort. The [/C] option will cause the output to be continuous (without pause) until the end is reached or ESC is pressed. • The alarm status of each tag is displayed. More than one alarm condition may be displayed. The following codes are common: OK - not in alarm A - in alert (transmitting)

	<p>H - high limit exceeded L - low limit exceeded D - rate of change exceeded</p>
SHUTDOWN	Causes the Xpert program to exit so that Xpert.exe, DLLs, and SLLs may be upgraded.
SMS [cmd]	<p>The SMS command allows commands normally issued via SMS text message to be issued at the command line. If cmd is omitted, the current state of the GPRS modem is displayed, example:</p> <pre> \Flash Disk>SMS GPR2: Standby-On next task SelfTimed at 17:30:05 NextST:17:30:05 LastAlarm:16:39:15 LastST:17:15:05 SMS2: Standby </pre> <p>Otherwise cmd is processed as follows:</p> <pre> STAP [url[:port]] Perform a "shoulder tap" by opening a GPRS connection to either the default command server or the specified url and port REDIR [url[:port]] Open a GPRS connection to the default redirector server or the specified url and port SETPIP [url] Set the PrimaryIP for GPRS connections SETSSIP [url] Set the SecondaryIP for GPRS connections SETMP [port] Set or show the TCP port to be used for GPRS messages SETTCP [port] Set or show the default TCP port to be used for GPRS command sessions SETRP [port] Set or show the default TCP port to be used for GPRS Redirector sessions HELP Displays this list </pre>
STARTUP	Runs Xpert.exe from the \Flash Disk folder if it's there, otherwise from the \Windows folder. Updates the AUTOEXEC.BAT if the location has moved.
STATION [name]	The STATION command will display a station's name. If a name is passed to the command, then the station name will be set and the change will take effect immediately.
STATUS [clear]	Display and or clear com port status
STOP name	Stops a process forcibly
TASKS	Displays tasks and heap usage
TIME [hh:mm:ss]	Displays or sets the time
TYPE file [/C]	Display a file to the screen. If the file is longer than 24 lines the display will pause with a "- More -" prompt until enter is

	<p>pressed to continue, or anything else to abort.</p> <ul style="list-style-type: none"> The [/C] option will cause the output to be continuous (without pause) until the end is reached or ESC is pressed.
OLDUPGRADE	<p>When running \Windows\Remote.exe this command exits and upgrades to a new version of Remote downloaded to the \Flash Disk folder.</p> <p>When running \Flash Disk\Remote.exe this command exits and downgrades to the original version in \Windows. In either case, command line settings are retained.</p>
UPGRADE [/YES] [/P]	<p>The UPGRADE command is used to upgrade system files using the Ymodem protocol. This previous version of this command is now called “OLDUPGRADE”. An “upgrade” can consist of a single new file to add to the system, or complete set of application files contained in a .ZIP file. The upgrade command cannot upgrade the kernel or the loader, only application files such as Xpert.exe, Remote.exe, DLLs, SLLs, .BAS files, etc are supported. The .UPG file used to perform upgrades with XTerm is not used. The user is prompted “Are you sure? ” and must respond with a “Y” or “y” before the upgrade proceeds. Following are the steps performed:</p> <ul style="list-style-type: none"> The Xpert application is shutdown. Any old application files on the \Flash Disk are deleted. This includes Xpert.exe, *.DLL, and *.SLL. <p>The file transfer is performed.</p> <p>The file or file(s) are then stored on the \Flash Disk.</p> <p>If the currently executing Remote.exe needs to be replaced, then Remote will shut itself down and restart the new version. This will drop the current connection.</p> <p>The Autoexec.bat file will be verified and/or modified to make sure that the correct version of Xpert.exe is executing (\Flash Disk\Xpert.exe if it exists, otherwise \Windows\Xpert.exe)</p> <p>The Xpert application is re-started (the one stored in the \Flash Disk folder if it exists, otherwise the one in the \Windows folder).</p> <p>Options:</p> <ul style="list-style-type: none"> The /YES option will bypass the “Are you sure? ” prompt. The /P option enables a partial upgrade for situations where just some of the files are being changed. Step 2 (the deletion of files) is skipped. This option can be used

	to download a new version of Remote, or to add some new .SLL files, or .BAS files.
VER	Displays the build date Remote was created
YMODEM [file-list] [/ZIP]	<p>With no options specified, the YMODEM command will receive files using the Ymodem protocol and store them on the Xpert. If the file being transferred has a .ZIP extension, then it will be automatically expanded and the contents stored in the current folder (typically \Flash Disk).</p> <p>The command may be used to send files using the Ymodem protocol by supplying a file name or a file-list. A file-list is simply a list of files to send (delimited by spaces; use quotes around files containing spaces).</p> <ul style="list-style-type: none"> • /ZIP may be used when sending files to cause the files to be compressed in to a .ZIP archive before being transferred. The name of the archive will be the same as the first file in the list with a .ZIP extension. • A transfer can be aborted by pressing ESC 3 times.

The command prompt supports a 10-line command recall capability invoked by pressing UP ARROW to scroll back through old commands, or DOWN ARROW to scroll to newer commands.

Most all commands support the /YMODEM, /ZIP, and /C options. Unless stated otherwise the default filename for the output of a command will be station_command.txt for a /YMODEM transfer or station_command.zip for a /ZIP transfer.

When a command displays more than 24 lines of output, the “– More –” prompt will be displayed. The user may press space to display another 24 lines, enter to display the next line, or C to start displaying lines continuously without break. The “more” mode of output may be re-enabled at any time by pressing M. Output may be terminated by pressing ESC.

The “REPORT” command defines message filters in Remote and in Xpert. Reporting requires extra processing that will slow operation of the unit. The options can be combined. For example to monitor COM2 for SSP messages, watch I2C messages, and observe debug messages, try the command:

```
\Flash Disk> report SSP2 I2C Debug
Reporting enabled and filter is set
```

Here’s a summary of what types of messages each option will display:

None or Off	No messages
SSP	SSP messages from any communication port, and error, warning, and status messages. SSP messages are decoded. SSP messages over TCP/IP are not displayed.
SSPn	SSP messages from the specified communication port, i.e. SSP4

	would show messages to/from COM4.. If SSP0 is specified then SSP messages transported by TCP/IP are displayed.
Low	Error messages
Medium	Error and warning messages.
High	Error, warning, and status messages.
All or On	Debug, error, warning, status and SSP messages from serial ports 1 through 9.
Debug	Debug, error, warning, and status messages.
I2C	Decoded I2C messages

The SSP Decoder displays the time of a message, the source and destination, the sequence number, the operation code, the size of the message, and partial decoding of the contents of the message.

SSP Decoder Example:

```
\Flash Disk> report SSP2
17:16:38 COM2: RTU>XCONNECT 4865191 TimeTag,16,09/18/2006
17:14:00,String,BAT,Real,12.529999 | TimeTag,20,09/18/2006
17:14:00,String,AirTemp,Real,72.799988 | TimeTagEnd,0
17:16:39 COM2: XCONNECT>RTU 11720692 Ack,1,TimeTagEnd
17:16:39 COM2: XCONNECT>RTU 11720942 SetClock,6,09/19/2006 17:16:42
17:16:45 COM2: XCONNECT>RTU 11721942 CurdataReq,0
17:16:45 COM2: RTU>XCONNECT 4871422
Curdata,30,BAT,2,0,Nil,1,Alarm,OK
```

ABOUT Command Example

```
\Flash Disk> ABOUT
File                               Version
=====                           =====
Xpert                              3.2.0.4
Kernel                             5.1.8
Monitor                            5.1.8, Mon 09/15/2008 14:02:13.60
Loader                             5.1.8
Remote                              3.2.0.4
\Xpert.exe                          3.2.0.4
\Windows\Engine.dll                 3.2.0.4
\Windows\Logger.dll                 3.2.0.4
\Windows\LogMgr.dll                 3.2.0.4
\Windows\LZO.dll                    3.2.0.4
\Windows\SDI.dll                    3.2.0.4
\Windows\Utils.dll                  3.2.0.4
\Windows\Deflib.sll                 3.2.0.4
```

Get Command Example

The Get command shows the data logged, picking up where the last Get left off (or end of log, if the first time run).

```
\Flash Disk> GET
[SSP.LOG]
10-26-2005 13:45:00 STAGE          1.20  G ft
10-26-2005 13:45:00 AIRTEMP      78.20  G F
10-26-2005 14:00:00 STAGE          1.21  G ft
10-26-2005 14:00:00 AIRTEMP      78.25  G F
10-26-2005 14:15:00 STAGE          1.22  G ft
10-26-2005 14:15:00 AIRTEMP      79.10  G F
10-26-2005 14:30:00 STAGE          1.20  G ft
10-26-2005 14:30:00 AIRTEMP      79.00  G F
10-26-2005 14:45:00 STAGE          1.20  G ft
10-26-2005 14:45:00 AIRTEMP      78.60  G F
```

The following shows the most recent data followed by older data:

```
\Flash Disk> GET /NEWEST /REVERSE
[SSP.LOG]
10-26-2005 14:45:00 AIRTEMP      78.60  G F
10-26-2005 14:45:00 STAGE          1.20  G ft
10-26-2005 14:30:00 AIRTEMP      79.00  G F
10-26-2005 14:30:00 STAGE          1.20  G ft
10-26-2005 14:15:00 AIRTEMP      79.10  G F
10-26-2005 14:15:00 STAGE          1.22  G ft
10-26-2005 14:00:00 AIRTEMP      78.25  G F
10-26-2005 14:00:00 STAGE          1.21  G ft
10-26-2005 13:45:00 AIRTEMP      78.20  G F
10-26-2005 13:45:00 STAGE          1.20  G ft
```

The following shows all bad stage data that occurred today:

```
\Flash Disk> GET STAGE /BAD /TODAY
[SSP.LOG]
10-26-2005 05:45:00 STAGE          1.01  B ft
10-26-2005 05:45:00 STAGE          1.24  B ft
```

The following shows all entries in the system log for the current week:

```
\Flash Disk> GET /F SYSTEM /WEEK
[SYSTEM.LOG]
10-23-2005 01:05:05 NOTE (Stat) - User Bob logged in.
10-23-2005 01:06:50 NOTE (Stat) - Loaded \Flash Disk\543.ssf setup
file.
10-23-2005 01:05:05 NOTE (Stat) - Running.
```

The following sends the last month of AIRTEMP and STAGE data via Ymodem to the PC in CSV format:

```
\Flash Disk> GET AIRTEMP,STAGE /F SSP /MONTH /CSV /YMODEM
Ready to send YModem file(s) (press ESC to abort)
```

Ymodem all non-STAGE data from August. ZIP it first to reduce the amount of data that needs to be transferred.

```
\Flash Disk> GET STAGE /INVERT /S 08-01-2005 /E 08-31-2005 /ZIP
Ready to send YModem file(s) (press ESC to abort)
```

INFO command Example

```
\Flash Disk> INFO
Recent Status:
  10/26 13:42 (Stat) - Remote user Bob logged in.
  10/26 13:42 (Stat) - Remote user Bob logged out. Active for 104
sec.
Com Status: Stopped
Memory Load 51 percent
Total Physical 7725056
Available Physical 3833856
Total Virtual 33554432
Available Virtual 29163520
Number of resets: 110
I2C STATISTICS:
#Rx:22 #Error:0 #Fail:0
#Tx:31 #Error:0 #Fail:0
NAK:0 TIMEOUT:0
COLLISN:0 OVRFLOW:0
BUSERR:0 RXERROR:0
SLAVETX:0 CHKSUM:0
STOP:0 BUSBUSY:0
RESTART:0 BADCHAN:0
Network Configuration
  DNS Servers . . . . . : 192.168. 168.1
  Ethernet adapter. . . : CS8900A1
  IP Address. . . . . : 192.168. 168.10
  Subnet Mask . . . . . : 255.255.255.0
  Default Gateway . . . : 192.168.168.1
```

MAIL Command Example

```
\Flash Disk> MAIL
Mailbox for COM2:
10/26/2005 16:23:53 Mail from: BASE, Remember to cal the 4-20 input!
10/26/2005 16:23:18 Mail from: BASE, This is a test mail message.
\Flash Disk> MAIL 2 BASE All taken care of, I'm leaving the site
now.
Mail delivered.
```

MEASURE/SHOW Command Example

The following measures all sensors and tags:

```
\Flash Disk> MEASURE
SENSOR
  BATVAL (Battery)          12.781 G V
  BATVAL (Temp)            28.767 G C
```

```

    STAGE                1.23  G ft
    AIRTEMP (Temp)       78.32  G F
    AIRTEMP (Humid)     25.32  G %
TAG
    STAGE                1.23  G H A
    AIRTEMP              78.32  G OK

```

Show just the AIRTEMP tag

```

\Flash Disk> SHOW AIRTEMP /TAG
AIRTEMP                78.32  G OK

```

Zip up the results of a show and transfer it to the PC using Ymodem.

```

\Flash Disk> SHOW /ZIP
Ready to send YModem file(s) (press ESC to abort)

```

Show all the sensor values in comma-separated format

```

\Flash Disk> SHOW /CSV /SENSOR
BATVAL (Battery), 12.7813835841049,G,V
BATVAL (Temp), 28.7679583945093,G,C
STAGE, 1.23,G,ft
AIRTEMP (Temp), 78.3253939059343,G,F
AIRTEMP (Humid), 25.3246839763986,G,%

```

PASSTHRU Command Example

```

\Flash Disk> PASSTHRU COM3:2400,N,8,1
Passthru operation has begun (press ESC ESC ESC to abort)
AT
OK

```

RECORDING Command Example

```

\Flash Disk> RECORDING OFF
Stopping.
Recording is OFF
\Flash Disk> RECORDING ON
Running.
Recording is ON

```

SET Command Example

- The following turns a pump called PUMPON on (set it to 1):

```

\Flash Disk> SET PUMPON 1
\Flash Disk> SHOW PUMPON /TAG
PUMPON                1      G OK

```

Turn a pump called PUMPON off (set it to 0)

```

\Flash Disk> SET PUMPON 0
\Flash Disk> SHOW PUMPON /TAG
PUMPON                0      G OK

```

SHUTDOWN Command Example

```
\Flash Disk> SHUTDOWN
Stopping.
The Xpert application has been shutdown.
```

STARTUP Command Example

```
\Flash Disk> STARTUP
Xpert has been started.
```

STATION Command Example

```
\Flash Disk> STATION site123
The station is named site123
```

STATUS Command Example

```
\Flash Disk> STATUS
COM1:115200,3.0,3,10.0,1.0 - bob(1) is logged in | Cmd: \Flash Disk>status
  SSP STATS: RX: 959, TOTAL: 959, BAD: 0 TX: 574, BAD: 0, FAIL: 0
RADIO2:9600,10.0,3,30.0,0.1 - Unknown (0) is logged out | Cmd:
  SSP STATS: RX: 2027, TOTAL: 2027, BAD: 0 TX: 1996, BAD: 0, FAIL: 0
VOICE3:115200,3.0,3,10.0,1.0 - Unknown(0) is logged out | Cmd:
```

UPGRADE Command Example

```
\Flash Disk> UPGRADE
Are you sure? Yes
Stopping.
The Xpert application has been shutdown.
Ready to receive YModem file(s) (press ESC to abort)
(ymodem send the new file or files in a .zip archive)
Upgrade complete: Restarting Xpert.
```

YMODEM Command Example

The following sends a file from your PC and place it on the Xpert using the Ymodem protocol:

```
\Flash Disk> YMODEM
Ready to receive YModem file(s) (press ESC to abort)
```

The following gets the files PUMP.BAS and FLUME.BAS from the Xpert and transfer them to your PC using the Ymodem protocol:

```
\Flash Disk> YMODEM PUMP.BAS FLUME.BAS
Ready to send YModem file(s) (press ESC to abort)
```

Get all setup files from the station, ZIP them up, and transfer them to your PC using the Ymodem protocol

```
\Flash Disk> YMODEM *.SSF /ZIP
Ready to send YModem file(s) (press ESC to abort)
```

APPENDIX H: TRANSMISSION FORMATS

Several transmission formats are available:

ASCII Column Format

The ASCII Column format is an ASCII, human readable format placing sensor values in columns, with each row containing data from earlier measurement intervals (newest data appears in top row).

The following example contains the last 3 measured values for 4 different sensors. Note how “//” is used to indicate “missing” data.

```
-4.422 35.00 136.16 37.00
-4.397 34.00 135.23 36.00
-4.324 33.00 134.88 //
```

The “right digits” property in the telemetry tag block (e.g., LAN, GPRS, etc.), determines the number of right digits that appear in the transmission.

The number of rows in the transmission is determined by the “Num Values” property in the transmission settings dialog.

Handar Format

The Handar format is an ASCII, human readable format where sensors are separated by <CRLF>, sensor data is separated with a space, and missing data is reported as “M”.

For example:

```
010034380517419:21:30G42+0NN155E9200070"
1.3 1.3 1.3 1.3
```

NFDRS and NIFC Formats

The NFDRS (National Fire Danger Rating System) and NIFC (National Interagency Fire Center) formats produce reports of human readable ASCII values using SHEF codes as labels for data.

The labels applied to measurement outputs are used to identify the data to include in the report. The following table shows what labels are recognized by the NIFC and NFDRS formatter. An “x” means the sensor label must appear in the setup for the formatter to succeed. The items with no “x” are recognized and will be formatted, but are not required.

Sensor	Label	NIFC	NFDRS
Rainfall	PCH	x	x
10-Min Avg Wind Spd	USH	x	x
10-Min Avg Wind Dir	UDH	x	x
Air Temperature	TAH	x	x
Fuel Temperature	MTH	x	
10-Min Avg Rel Hum.	XRH	x	x
Battery Voltage	VBH	x	x
Barometric Pressure	PAH		
Peak Wind Direction	UGX		
Peak Wind Speed	UPH		
Fuel Moisture	MMH		
Solar Radiation	RDH		x

Here’s an example NIFC telemetry report:

00.00

000

270

328

110

100

14.0

000
000
020
0486

Here's an example NFDRS telemetry report:

00.00
000
270
328
110
100
14.0
000
000
020
0486

Note how there are no labels in the report. This is because the position of the data within the report determines the source of the data.

Pseudobinary Formats

Pseudobinary formats produce ASCII reports of 6-bit pseudo-binary formatted data values. The formats are “pseudo”-binary, because each sensor value is expressed in the range of ASCII characters, but not in such a way that is readily human-readable.

Pseudobinary B (Interleaved “Bin Int”, and Non-Interleaved “Bin Non-Int”)

The Pseudobinary-B Interleaved format is identical to the 8210 binary transmission format. “Interleaved” means the most recent values of all sensors come first, followed by the next most recent, and so on. “Non-interleaved” means all the data for sensor 1 is followed by all the data for sensor 2, and so on, i.e., the data is not “interleaved” according to time.

This pseudobinary format cannot be easily read by a person. Here's is an example message:

		transmission, “2” meaning an alarm transmission, and “3” indicating a forced transmission.
Measurement Delimiter	1	This byte is always a “+” and it is used to denote the start of measurement data.
Measurement Index (Sequence)	1	The Sequence number assigned by user in the output telemetry settings. This value is encoded 6 bit binary. Typically, the sequence number assigned is unique, allowing you to uniquely identify the data point.
Day	2	This 2 byte encoded 6 bit binary encoded number represents the Julian day of the year. The day tells when the most recent (first) sensor reading of this measurement was made.
Time	2	This 2 byte encoded 6 bit binary encoded number is a number of minutes into the day. It tells when the most recent (first) sensor reading of this measurement was made.
Interval	2	This 2 byte encoded 6 bit binary encoded number tells the measurement interval in minutes, or the amount of time between readings of this measurement.
Measurement Data	3 for each sensor reading	Sensor data encoded 6 bit binary.
Additional Measurements	Variable	If more than one measurement was setup for transmission, more data will follow. Each measurement setup will have data starting with the Measurement Delimiter and ending with Measurement Data.
Final Delimiter	1	This byte is always “.” and it is used to denote the end of all measurement data.
Battery voltage	1	This is the battery voltage measured prior to making the transmission. The range of the number will be -32 to +31 and can be converted to volts by multiplying by 0.234 and adding 10.6 allowing a range of 3.1 to 18.1 volts.

Example Pseudobinary-C message:

```

C3+ADGTU?///+BDGTU?@UI+CDGTU??~v///.L
Group      3 format C
Sequence   A  1
Julian Day      DG 263
Time          TU 21:41
Interval      ?  00:-1
Data:         ///missing
Sequence      B  2
Julian Day      DG 263
Time          TU 21:41
Interval      ?  00:-1
Data:         @UI 1353
Sequence      C  3
Julian Day      DG 263
Time          TU 21:41
Interval      ?  00:-1
Data:         ?~v-74
                ///missing
Batt V      L  13.4

```

Pseudobinary-D Format

This is another compact data format. It differs from Pseudobinary B in that it has a timestamp at the start of the message. The timestamp indicates when the transmission should have taken place and helps decode when the data was collected. Pseudobinary D is 4 bytes larger than format B.

The timestamp is similar to the one in Pseudobinary C. Pseudobinary D is smaller than Pseudobinary C and it lacks detailed timestamps that would allow one to completely reconstruct the time the data was collected from the message itself. To correctly use Pseudobinary D, the decoder needs to know the measurement setup used.

The benefit of using Pseudobinary D is being able to correctly decode data regardless of when it was sent or received. This allows stations to re-transmit old data and have it correctly interpreted by the decoder while keeping the message size at a minimum.

Name	Bytes	Description
Block ID	1	BLOCK-IDENTIFIER is always sent as "D" to indicate that this is the pseudobinary D format.
Group ID	1	GROUP-ID can be "1" to indicate a scheduled transmission, "2" meaning an alarm transmission, and "3" indicating a forced transmission, or "4" indicating a retransmission
Day	2	This 2 byte encoded 6 bit binary encoded number represents the Julian day of the year. The day tells when the transmission was originally scheduled to take place
Time	2	This 2 byte encoded 6 bit binary encoded number is a number of minutes into the day. It tells when the transmission was originally scheduled to take place
Measurement	3 for each	Sensor data encoded 6 bit binary. The value

Data	sensor reading	transmitted will be value * 10 ^{RightDigits} . The string /// will be sent if the data was never measured or had bad quality
Battery voltage	1	This is the battery voltage measured prior to making the transmission. The range of the number will be -32 to +31 and can be converted to volts by multiplying by 0.234 and adding 10.6 allowing a range of 3.1 to 18.1 volts.

Six-Bit Binary Encoded Format

The six bit binary format is used to encode numbers into displayable ASCII characters. Notice that fractional numbers cannot be represented, so for instance a battery voltage of 13.04 volts set up with 2 right digits will be sent as 1304.

- A 1 byte encoded number can range from -32 to +31.
- A 2 byte encoded number can range from -2048 to +2047
- A 3 byte encoded number can range from -131072 to +131071

Binary encoded numbers are always sent most significant bytes first. The number itself is broken down into 6-bit digits, and each digit is placed in one byte of data. The number 64 (ASCII "@") is added to each digit to make it fall within the range of displayable ASCII characters. The only exception is that 127 (ASCII) is sent as 63 (ASCII "?")

Example 1. Encoding the number 10 in 1 byte:

Since 10 will fit in 6-bits we only have to add 64 which would yield 74. So the number 10 would appear as ASCII 74 or the letter "J".

Example 2. Encoding the number 12345 in 3 bytes:

First we have to convert 12345 into binary in 6-bit pieces:

$$12345 \text{ (base 10)} = 11\ 000000\ 111001 \text{ (base 2)}$$

Now we can convert each piece back to base 10:

$$11\ 000000\ 111001 \text{ (base 2)} = 3, 0, 57$$

Finally, we add 64 to each piece and convert to ASCII:

$$67, 64, 121 = \text{ASCII "C@y"}$$

Example 3. Encoding the number -12345 in 3 bytes:

First we have to convert -12345 into two's complement 18-bit binary: -12345 (base 10) = 111100 111111 000111 (base 2)

Now we can convert each piece back to base 10: 111100 111111 000111 (base 2) = 60, 63, 7

NOS

“NOS” format conforms to NOS requirements for its tidal stations. The label assigned in the telemetry setup block is used to identify to the formatter the different sensors that must be included in the message. You must put the proper labels for each sensor or the formatter will not be able to locate the sensor to transmit it. The labels are as follows:

Station Datum	DAT
Sensor offset	SNS
Primary water level	WL
Aquatrak sigma	SIG
Aquatrak outlier cnt.	OUT
Aquatrak temp. 1	AQT1
Aquatrak temp. 2	AQT2
Wind speed	WS
Wind direction	WD
Wind gust	GST
Air temperature	AT
Water temperature	WT
Barometric pressure	BP
Battery voltage	BAT

NFDRS

“NFDRS” format conforms to NFDRS requirements for its fire weather stations.

```
00.00  
000  
270  
328  
110  
100  
14.0  
000  
000  
020  
0486
```

Telemetry setup block labels tell the formatter how to format the data:

Sensor	Label	Format
--------	-------	--------

Rainfall	PCH	xx.xx
10-Min Avg Wind Spd	USH	xxx
10-Min Avg Wind Dir	UDH	xxx
Air Temperature	TAH	xxx
Fuel Temperature	MTH	xxx
10-Min Avg Rel Hum.	XRH	xxx
Battery Voltage	VBH	xx.x
Barometric Pressure	PAH	xx.xx
Peak Wind Direction	UGX	xxx
Peak Wind Speed	UPH	xxx
Fuel Moisture	MMH	xxx
Solar Radiation	RDH	xxxx

INSAT

“INSAT” format is a binary message, conforming to INSAT requirements for its stations. The labels assigned in the telemetry setup blocks are used to identify the sequence and formatting parameters to use when formatting the message. For each label, an id, offset and scale are associated.

The standard INSAT message encodes the id in an unsigned 4 bit integer, and encodes the data value in an unsigned 10 bit integer. The id is a unique integer from 0 to 19 and is used to determine order (note, however, that since INSAT only uses 4 bits to encode ids, ids appear to start over after 15; this typically requires that decoders consider position, in addition to id).

Encoded values are computed as in the following...

$$\text{encoded value} = ((\text{input data} + \text{offset}) * \text{scale} + 0.5)$$

Sensor	Label	Id	Offset	Scale
Avg. Air Temperature	AT	0	50.0	10.0
Max Air Temperature	ATMax	1	50.0	10.0
Data's integer in id 1, fraction to 3 digits in id 2.	R312	1, 2	0.0	1.0
Min Air Temperature	ATMin	2	50.0	10.0
Soil Temperature	ST	3	50.0	10.0
Data's integer in id 3, fraction to 3 digits in id 4.	R334	3, 4	0.0	1.0
Avg. Atmospheric Pressure	AP	4	-600.0	2.0

Relative Humidity	RH	5	0.0	10.0
Data's integer in id 5, fraction to 3 digits in id 6.	R356	5, 6	0.0	1.0
Net Radiation	NR	6	0.0	0.25
Data's integer in id 7, fraction to 3 digits in id 8.	R378	7, 8	0.0	1.0
Wind Speed	WS	8	0.0	10.0
Wind Direction	WD	9	0.0	1.0/.36
Sun Duration	SunD	10	0.0	0.5
Precipitation Duration	PrecipD	11	0.0	0.5
Albedometer (skyward)	AlbIn	12	0.0	0.5
Albedometer (downward)	AlbOut	13	0.0	0.5
Global Radiation	Global	14	0.0	1.0
Instantaneous Snow Depth	ISD	15	0.0	100.0
Snow Depth	SD	16	0.0	100.0

Offset is the offset of the sensor's range from 0. Scale is the representable range divided by the range of the sensor.

If the label entered is not in the table above, then it is interpreted as an integer to be used as the Id for the data. An Offset of 0 and a Scale of 1 are assumed when encoding the value in this case. This enables new sensor data to be included in INSAT transmissions without having predefined labels. If a different Offset and/or Scale is required, it can be implemented using a Polynomial block connected in-line prior to the Self-Timed parameter block.

BUFR

“BUFR” format is a binary message, conforming to WMO BUFR requirements for data transmissions and storage.

When BUFR is the selected format, the telemetry block used to “tag” the data for transmission has the following properties:

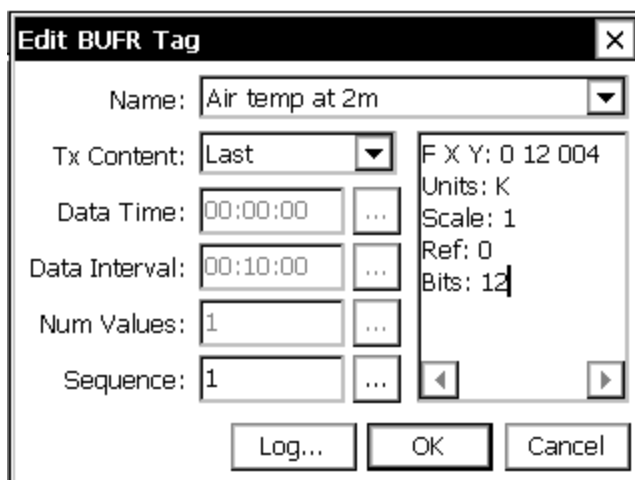

Name

The Name field describes the data to be transmitted. The Name corresponds to the Name (or sometimes called, “Description”), found in the WMO BUFR Table B. The read-only text pane to the right, updates as Name is changed, to show the following details from Table B:

Descriptor (F X Y)	The F X Y descriptor that uniquely identifies the data from Table B, e.g., 0 12 004 for “Air Temp at 2m”
Units	The units of the transmitted data
Scale	The scale applied to the data prior to transmission. Note, scale is applied as follows: transmitted data = measured value times 10 raised to the power of scale.
Ref	Reference Value subtracted from measured value after scaling, prior to transmission.
Bits	Data width in bits allowed for the transmitted value

Expanding Table B

The logger has an internal version of the WMO Table B that includes a handful of commonly transmitted values. If the internal table does not contain the values you need to transmit, create a text file called “BUFRTableB.txt”, add the desired items in the format described below, and copy the text file to the logger’s Flash Disk. Here is the format of the text file:

F, X, Y, Name, Units, Scale, Reference, Bits

For example:

0,1,1,WMO block number,Numeric,0,0,7
 0,1,2,WMO station number,Numeric,0,0,10
 0,5,2,Latitude (coarse accuracy),deg,2,-9000,15
 0,6,2,Longitude (coarse accuracy),deg,2,-18000,16
 0,7,4,Pressure,Pa,-1,0,14
 0,11,1,Wind direction,degree true,0,0,9
 0,11,2,Wind speed,m/s,1,0,12
 0,11,35,Vertical gust acceleration,m s-2,2,-8192,14
 0,12,1,Temperature/air temperature,K,1,0,12
 0,12,4,Air temp at 2m,K,1,0,12
 0,13,3,Relative humidity,%,0,0,7
 0,13,23,Total precip past 24 hours,kg m-2,1,-1,14
 0,13,55,Intensity of precipitation,kg m-2 s-1,4,0,8
 0,14,30,Direct sol rad/period (high accuracy),J m-2,-2,0,20
 0,14,32,Total sunshine,h,0,0,10
 0,25,25,Battery voltage,V,1,0,9

Tx Content, Data Interval, Data Time, and Num Values

These properties define what data to include in the transmission. See the following table for details:

Tx Content		Description of data to transmit
All		All the data measured since the last transmission (or up to Num Values for interleaved formats), will be transmitted
Individual		Individual values are selected for transmission based on timestamp
	Data Interval	The time interval between readings. For example, "01:00:00" means "hourly data"
	Data Time	The time, or offset into the interval, of the data to include. For example, "00:15:00" means "include data measured on a 15 minute offset"
	Num Values	Number of values for each data item to include in the transmission. Enabled only for non-interleaved transmission formats. When interleaved, the Num Values setting associated with the telemetry device is used.
Last		Only the last measured value will be transmitted (or the last Num Values, for interleaved formats)
Exclude		Exclude this item from transmission

Sequence

This property determines the order of the data item within the transmission.

The "Log..." Button

The "Log..." button opens a dialog used to select the backing log containing the data for transmission.

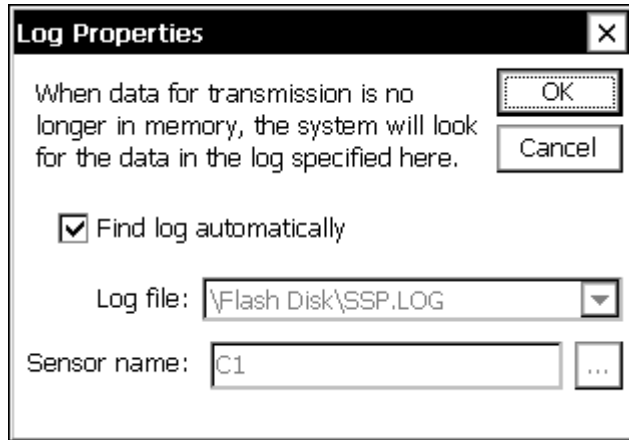

The system normally stores transmission data in memory, and only resorts to searching the log when the data is not found there (e.g., due to power-loss). The system normally selects the backing log automatically. If the automatic selection is incorrect, uncheck “Find log automatically” and specify the log manually.

Note: The system is unable to use log records as a backing log for transmission data (i.e., data logged using the LogRec and LogField blocks).

BUFR Content Options

When the selected format is “BUFR”, the telemetry device settings (e.g., Satlink, LANTx, GPRS, or Iridium), offer the following BUFR content option settings for edit (accessed by pressing the “BUFR” button on the telemetry device settings dialog):

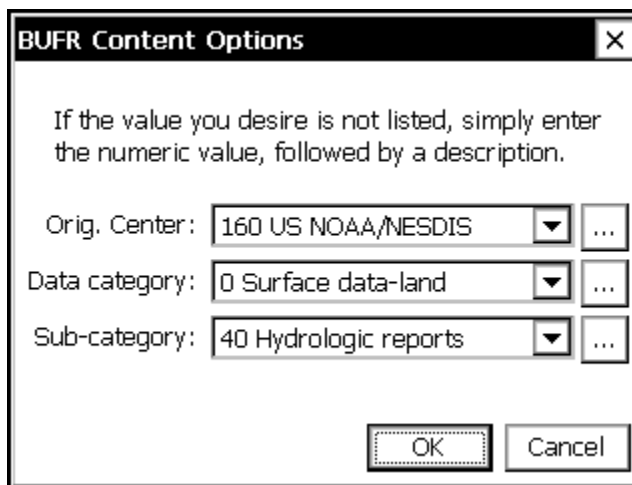

Originating Center

Select the originating to use in the BUFR message. If the desired center is not listed in the dialog drop-down, simply enter the desired value, with its numeric component, first (e.g., “34 - My originating center”). If the field is left blank, 0 is used.

Data Category

Select the data category to use in the BUFR message. If the desired category is not listed in the dialog drop-down, simply enter the desired value, with its numeric component, first. If the field is left blank, 0 is used.

Data Sub-category

Select the data subcategory to use in the BUFR message. If the desired subcategory is not listed in the dialog drop-down, simply enter the desired value, with its numeric component, first. If the field is left blank, 0 is used.

APPENDIX I: DIMENSIONS

XPERT2 DATA LOGGER

Dimensions shown are in inches:

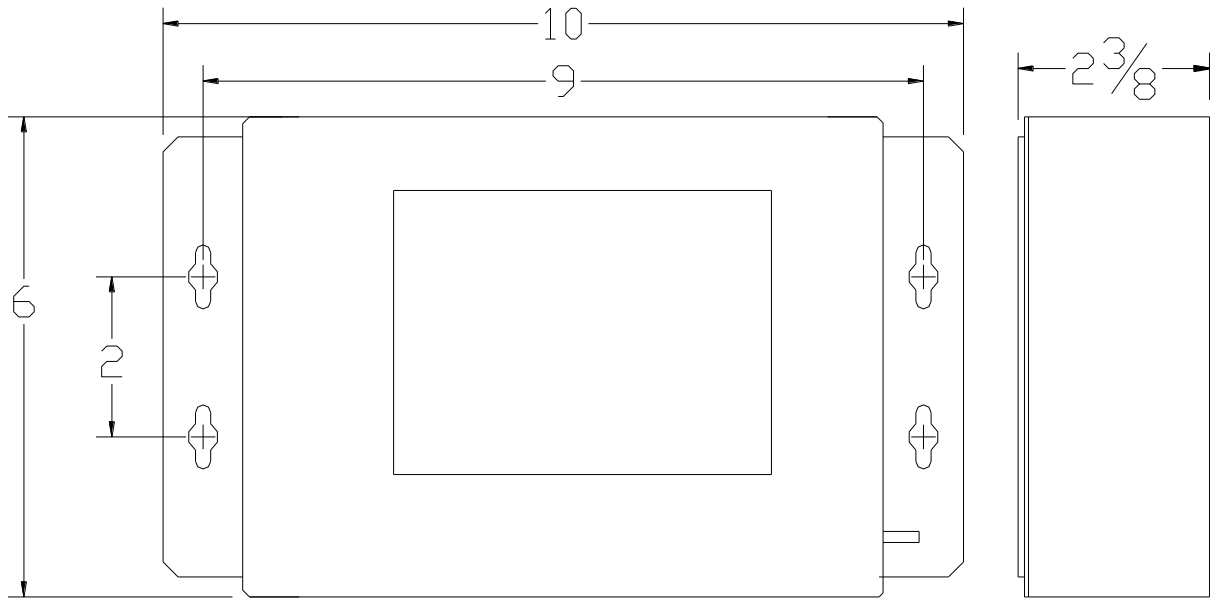

With supplied mounting feet.

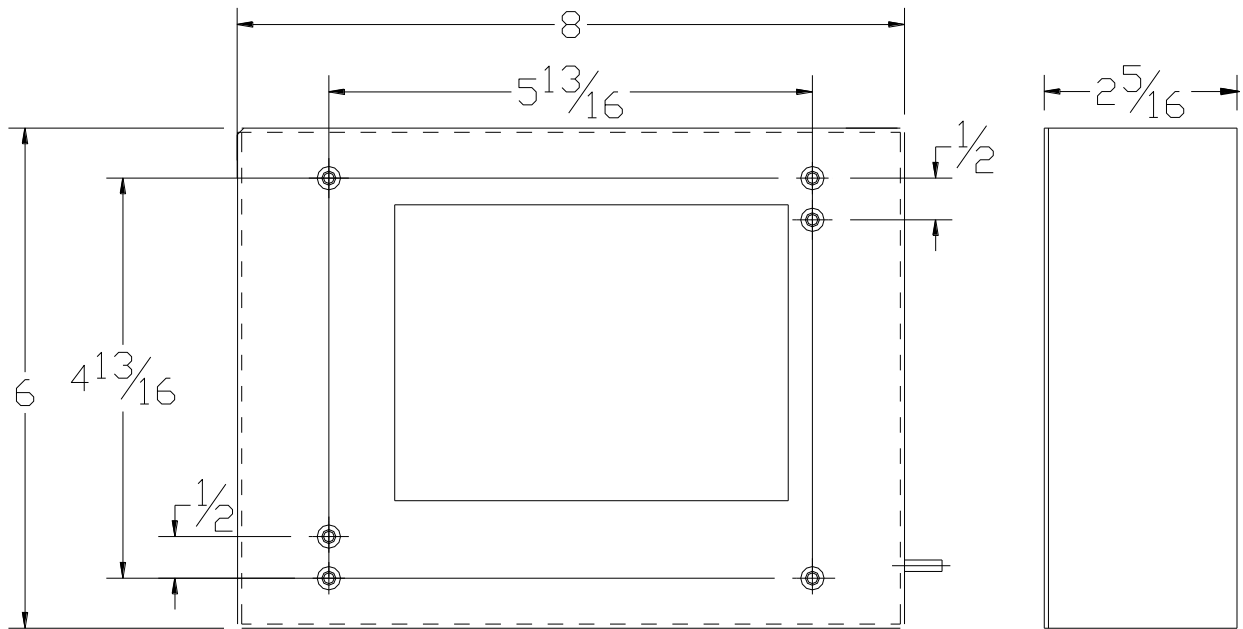

With mounting feet removed

IO MODULES

Dimensions shown are in inches. Note that on the 8080-0007 module, the two 6-32 screws located 3.00 inches apart on the rear of the module provide the earth grounding for the transient protection.

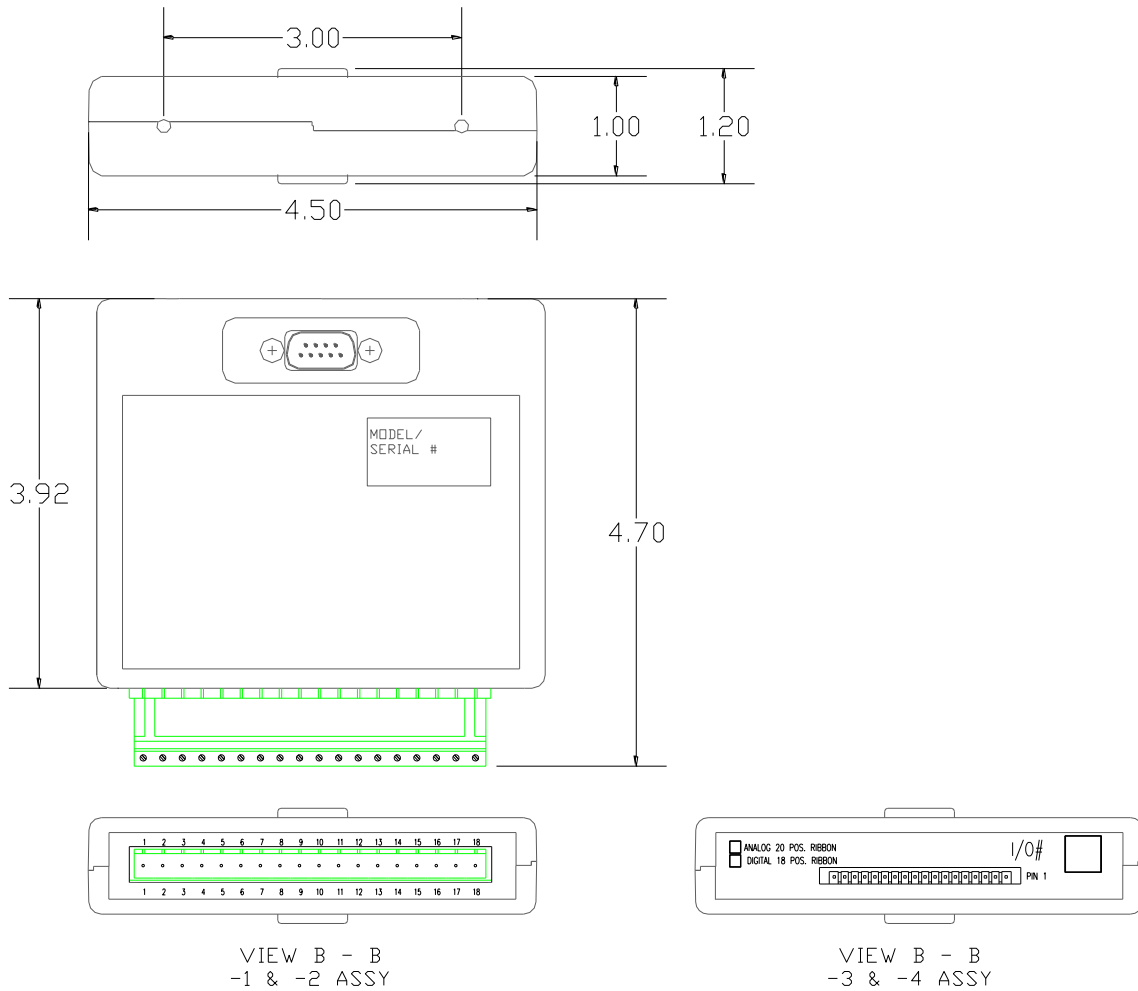

XPERT MODEM

Dimensions shown are in inches:

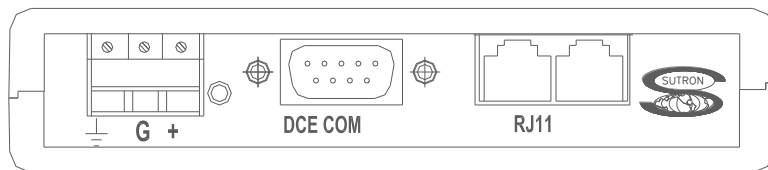
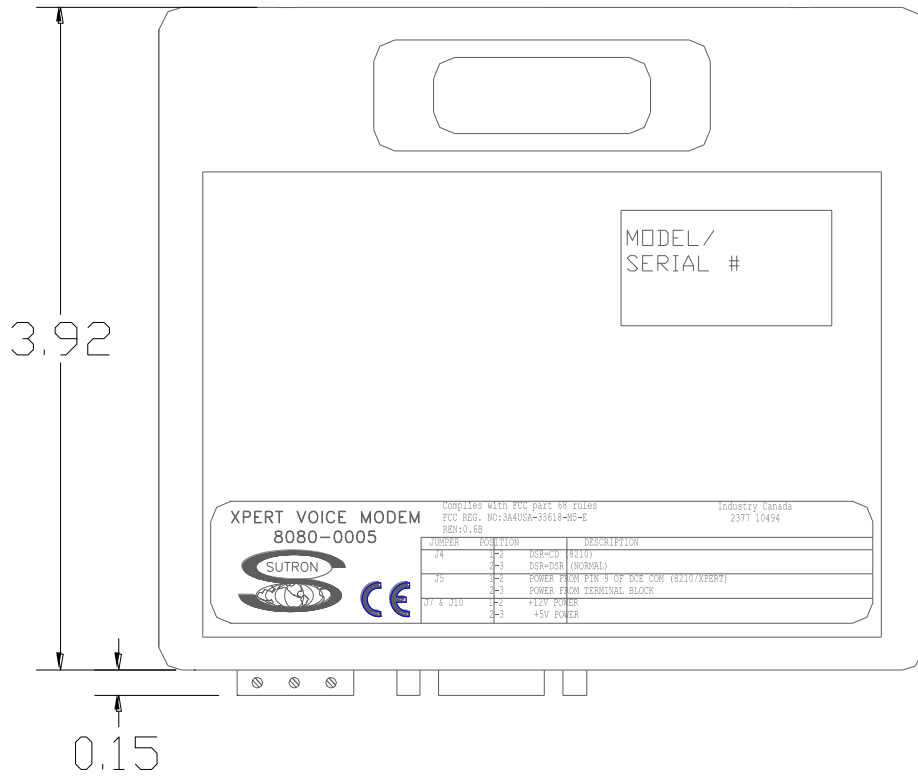
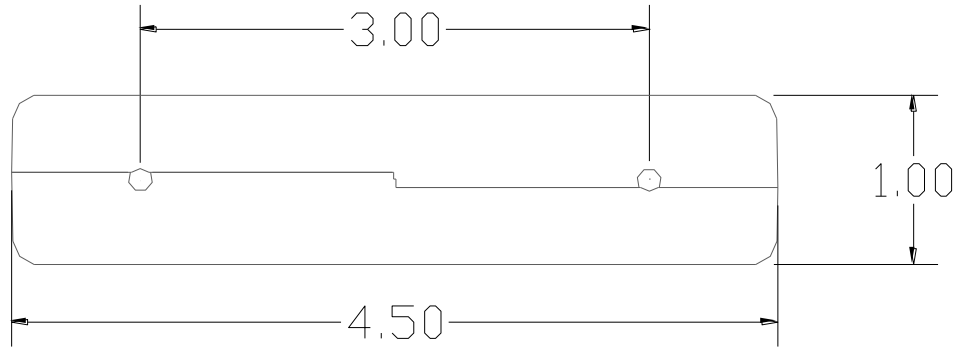

Index

5

5600-0600, 193
5600-0601, 193
5600-0602, 193
5600-0603, 193
5600-0605, 193
56-109 Submersible Pressure Transducer,
195

8

8080-0000-1, 5, 278
8080-0000-2, 5, 278
8080-0000-3, 5, 15, 126, 278
8080-0001-1, 5, 278
8080-0001-2, 5
8080-0002-1, 5, 274
8080-0002-4, 5
8080-0003 Analog I/O Module
configuration examples, 270
8080-0003-1, 5, 266
8080-0003-3, 5
8080-0005-1, 5, 279
8080-0006-1, 163
8080-0007 Analog I/O Module
configuration examples, 273
8080-0007-1, 5, 271

A

About dialog, 72
access levels, 18
accounts
managing, 60
overview, 18
users.dat, 122
accuracy
Analog I/O module, 269
ADC block, 139–44
Air Temperature sensor block, 137
Air Temperature/Relative Humidity sensor
block, 139
Alarm block, 23, 200
alarms
block, 200

configuring, 23–41, 54, 164, 200, 240,
241, 252
Digital I/O Module features, 274
alerts, 23–41
Analog block, 139–44
Analog I/O Module
accuracy, 269
inputs, 268
measurements, 268
operational states, 268
outputs, 268
plug assignments, 266, 271
appending
random transmissions, 54
self-timed transmissions, 52
Aquatrak block, 187
AT/RH block, 139
Auto Update, 113
autoexec.bat, 132, 286
Average Block, 203, 209

B

bad data quality, 69
Barometric Pressure sensor block, 146
battery
Internal Battery block, 170, 171
replacing, 133
BEIEnc block, 147
Bin_Int format, 52, 54, 303, 304
Bin_NonInt format, 52, 54
Binary Input – All Channels block, 150
Binary Input block, 148
binary input mode, 150
Binary Out block, 250, 251
BinIn block, 148
BinInAllChan block, 150
BinOut block, 250, 251
blocks
adding, 83–86
categories, 79
connecting, 80
control blocks. *See* control blocks
deleting, 91
inputs and outputs, 79

log blocks. *See* log blocks, *See* log blocks,
 See log blocks
miscellaneous blocks. *See* miscellaneous
 blocks
overview, 3
processing blocks. *See* processing blocks
properties, 81, 86
sensor blocks. *See* sensor blocks
telemetry blocks. *See* telemetry blocks
wiring, 89
Bool, 205
BP block, 146
Bridge Resistance block, 152
Burst, 54, 55
Burst Int, 54

C

calibrate
 sensors
 XPert, 63
 touchscreen, 132
CapRain block, 153
Center in Window, 51
channel
 binary input, 148
 random, 54
 self-timed, 52
cleaning, 134
clearing log, 69
Com ports
 configuring, 23–28
COM ports
 pin assignments, 125–27
 testing, 28
Communication Test Menu, 28
Coms Tag block, 240
COMx, 287
connection settings in XTerm, 113
Constant block, 155
ConstIn block, 155
contrast, 18
 adjusting from Login screen, 9, 133
 adjusting from Main tab, 20, 133
control blocks. *See Also* blocks
 Binary Out, 250
 Pulse Out, 251

Control Panel tab, 22–62
count, 203, 209
Counter block, 157
Counts per Turn drop down box, 183
CS107 Temperature sensor block, 159
CS505 Fuel Moisture sensor block, 163
current measurement, 140, 144

D

data column (log file), 68
data modem. *See* modems:data modem
date
 column (log file), 69
 setting, 19
Day buttons, 69
Deleting a Block, 91
Deleting Multiple Blocks, 91
Dew point block, 206
Dial-In Commands, 30
Dial-Out Commands, 30
Digital I/O Module, 274
 counters, 275
 digital filters, 275
 features, 274
 frequency, 275
 inputs, 275
 outputs, 276
 plug assignments, 274
 shaft encoders, 275
 specifications, 274
direct connect, 23–29
Display block, 253
DLLs, 3
 overview, 3
DoubleVolts, 143

E

enable
 excitation channel, 145
 random transmissions, 53, 246
 self-timed transmissions, 51
 temperature, 146
excitation channel, 145
exit, 73
exporting log files, 68, 70
EzSetup Measurements, 35

Add sensor, 37
New Measurement, 36
overview, 3
Sensor Configuration, 37

F

Field Variable blocks, 66, 254
File Transfer, 110
Find button, 64, 69
FM block, 163
formats, transmission, 52, 54
Formatting
 pseudobinary, 304
Freq block, 161, 208
Frequency block, 161
Fuel Moisture sensor block, 163
fuses, 134

G

GetTag block, 164
Gill Wind block, 165
good data quality, 69
Graycode input mode, 150
GUI
 operation, 17–73

H

Hi Alarm, 201

I

I/O Modules, 3, 9, *See* Analog I/O Modules,
 Digital I/O Modules
I²C Modules specifications, 278
Initialize Satlink, 51
Insert a Block, 92
installation
 autoexec.bat, 286
 COM ports, 125–27
 remote.exe, 287
 XPert, 122–24
 XTerm, 104
Internal Battery block, 170, 171
Interpolate block, 211, 213

K

kernel
 updating, 263

L

Lat/Lon, 52, 54
linear sensors, 138
live measurements, 63
log blocks, 232, 234, 236, *See Also* blocks,
 See Also blocks, *See Also* blocks
log files
 blocks. *See* log blocks, blocks, *See* log
 blocks, blocks, *See* log blocks, blocks
 clearing, 69
 creating, 47
 data column, 68
 date column, 69
 Day buttons, 69
 exporting, 68, 70
 Find button, 69
 managing, 47
 navigating, 69
 properties, 47
 Q (quality) column, 69
 selecting, 69
 sensor column, 68
 time column, 68
 units column, 69
 viewing, 68
login, 18
logout, 18, 21
LOS Radio modem. *See* modems:LOS radio
 modem
Low Alarm, 201

M

Main tab, 19–21
maintenance, 21, 132
max, 202, 203
Measure block, 214
measurements
 analog, 139–44, 268
 live, 63
min, 202, 203
Minimum/Maximum block, 215

miscellaneous blocks. *See Also* blocks

Display, 253
Set Field Variables, 254

models, 5

modems

data modem, 34
installation, 122–24, 125–27
LOS Radio modem, 34, 279
speech modem, 5, 278

MODEMx, 287

Moving Average block, 216

multiplier, 161

N

NESDIS, 52, 308

NFDRS format, 52, 309, 310, 311

NIFC format, 302

Norm Rate, 54

NOS format, 52, 309

O

operation, 17–73

P

passwords, 18, 62

period, 161

Platinum RTD block, 178, 181

Polynomial block, 217

powering up, 9

Precip block, 196

precision, 88

prefix, 240

processing blocks. *See Also* blocks

Alarm, 200

Average, 202, 203, 209

Boolean, 205

Interpolate, 211, 213

Measure, 214

Minimum/Maximum, 215

Moving Average, 216

Point Control, 218

Polynomial, 217

Set Point Control, 220, 221

Solar Radiation Accumulation block, 222

Vector Average, 224

XY Function, 226, 231

Processing blocks

Dew Point, 206

pseudobinary format

random transmission, 304

PtCtrl, 218

Q

Quadrature Shaft Encoder block, 183

quality

appending to random transmission, 54

appending to self-timed transmission, 52

column (log file), 69

R

radio modem. *See* modems:LOS Radio
modem

RADIOx, 287

Random Group block, 241

Random Parameter block, 246

Random Properties, 53

Random Test, 56

Rate, 53, 54

recording status

XPert, 20

Refresh button, 57, 72

remote.exe, 286, 287

Reset button, 43, 57

Reset FS button, 57

resistance measurements, 140, 141, 144

Right Digits, 307

RM Young Wind Sensor block, 184

RndGroup block, 241

ROC Alarm, 201

RS232 modules specifications, 278

RS-485, 5, 15, 24, 25, 34, 126

S

sample

duration, 203, 210

interval, 203, 210

satellite ID, 50

Satlink

description, 279

installation, 122–24, 125–27

properties, 50

random properties, 53

- random test, 56
- self-timed properties, 51
- self-timed test**, 55
- Status, 57
- schedule
 - interval, 203, 210
 - time, 203, 210
- SDI AquaTrak block, 187
- SDI-12. *See Also* Digital I/O Modules
 - commands, 64
- SDI-12 block, 186
- SDIAqua block, 187
- SDK, 282, 284
- SE8500 block, 188
- Self-Timed Parameter block, 247
- Self-Timed properties, 51
- Self-Timed Test**, 55
- SendTag block, 252
- sensor blocks. *See Also* blocks
 - Air Temperature, 137
 - Air Temperature/Relative Humidity, 139
 - Analog, 139–44
 - Barometric Pressure, 146
 - BEI Absolute Encoder, 147
 - Binary Input, 148
 - Binary Input - All Channels, 150
 - Bridge Resistance, 152
 - CapRain, 153
 - Constant, 155
 - Counter, 157
 - CS107 Temperature Sensor, 159
 - Frequency, 161, 208
 - Fuel Moisture, 163
 - GetTag, 164
 - Gill Wind, 165
 - Internal Battery, 170, 171
 - Platinum RTD, 172, 173, 175, 178, 181
 - Quadrature Shaft Encoder, 183
 - R.M. Young Wind, 184
 - SDI AquaTrak, 187
 - SDI-12, 186
 - SE8500, 188
 - Soil Moisture, 167, 189, 190, 192
 - Solar Radiation, 193
 - Submersible Pressure Transducer, 195
 - Tipping Bucket, 196
 - Volt Meter, 198, 199
- sensor column (log file), 68
- sensors
 - calibrating, 63
 - live measurements, 63
 - properties, 63
 - sending SDI-12 commands, 64
 - viewing, 63, 65
- Set Clock. *See Also* date:setting, time:setting
 - XTerm control, 112
- Set Field Variables block, 254
- Set Point Control block, 220, 221
- SetFieldVar block, 254
- SetPoint block, 220, 221
- setup. *See Also* blocks
 - blocks. *See* blocks
 - example, 79
 - modify, 89
 - new, 83
- setup blocks. *See* blocks
- Shaft Encoder block, 183
- SHEF format, 52, 308
- SLLs, 282
- Software Development Kit, 282, 284
- Soil Moisture block, 167, 189, 190, 192
- Solar Radiation Accumulation block, 222
- Solar Radiation sensor block, 193
- specifications
 - basic unit with display, 278
 - basic unit without display, 278
 - Digital I/O Module, 274
 - I²C modules, 278
 - RS232 modules, 278
- speech
 - Coms Tag block, 240
 - files
 - creating, 284
 - loading, 122
 - introduction, 23
 - modem. *See* modems:speech modems
- SR block, 193
- SSP, 164, 240, 252
- standard deviation, 202, 203, 209
- station name
 - XPert, 20
- Status button, 55, 56

Status Options dialog, 72
STD, 202, 203, 209
Submersible Pressure Transducer block, 195
SubPres block, 195
suffix, 240
Sutron Link Libraries, 282
Sutron Speech/Voice modem. *See*
modems:speech modem

T

telemetry blocks. *See Also* blocks
Coms Tag, 240
Random Group, 241
Random Parameter, 246
Self-Timed Parameter, 243, 247
SendTag, 252
Telemetry modules, 5
temperature sensor block. *See* Air
Temperature sensor block, Air
Temperature/Relative Humidity sensor
block, CS107 Temperature sensor block
Test check box, 155
tests
communication, 28
I/O Modules, 9
random, 56
self-timed, 55
touchscreen, 9
thermistor, 137, 138, 142, 159
time, 53
column (log file), 68
setting, 19, 112
Tipping Bucket Sensor block, 196
touchscreen
calibrating, 132
troubleshooting, 132
Type, 53, 54

U

units column (log file), 69
unpacking, 8
update
application, 264
extension, 263

kernel, 263
remote.exe, 287
Upgrade, 113
users, 18, 57, 58, 60

V

VectAvg block, 224
Vector Average block, 224
View Data tab, 65
View Log tab, 21–62
voice modem. *See* modems:speech modem
VOICEx, 287
Volt Meter block, 198, 199
voltage measurement, 140, 143
VoltMeter block, 198, 199

W

Web Server, 113
window, transmission time, 53
Wire button, 90, 91
wiring, 89
wrap, 47

X

XPert
installation, 122
models, 5
picture, 4
product description, 4
XTerm. *See Also* remote.exe
auto update, 113
connect, 113
file transfer, 110
installation, 104
introduction, 104
operating, 108
preparing the XPert to work with XTerm,
108
set clock, 112
Upgrade, 113
web server, 113
XY Function block, 226, 231
XYFunc block, 226, 231